

Xinger®

Ultra Low Profile 0805 Balun 75Ω to 100Ω Balanced

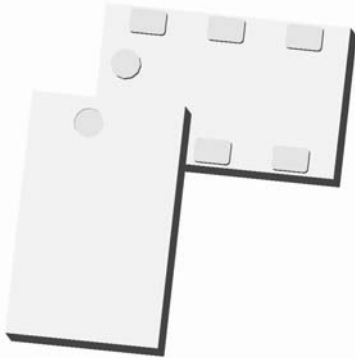

Description

The BD0922J75100AHF is a broadband low profile sub-miniature balanced to unbalanced transformer designed for differential inputs and output locations on next generation wireless chipsets and any application requiring an impedance transformation in an easy to use surface mount package. The BD0922J75100AHF is ideal for high volume manufacturing and is higher performance than traditional ceramic and lumped element baluns. The BD0922J75100AHF has an unbalanced port impedance of 75Ω and 100Ω balanced port impedance. This transformation enables single ended signals to be applied to differential ports on modern semiconductors. The output ports have equal amplitude (-3dB) with 180 degree phase differential. The BD0922J75100AHF is available on tape and reel for pick and place high volume manufacturing.

Detailed Electrical Specifications: Specifications subject to change without notice.

Features:	Parameter	ROOM (25°C)			Unit	
		Min.	Typ.	Max		
<ul style="list-style-type: none"> • 900 – 2200 MHz • 0.7mm Height Profile • 75 Ohm to 2 x 50 Ohm • Broadband applicability • Covers all commercial communications bands in one part • Low Insertion Loss • Surface Mountable • Tape & Reel • Non-conductive Surface • RoHS Compliant • Halogen Free 	Frequency	900		2200	MHz	
	Unbalanced Port Impedance		75		Ω	
	Balanced Port Impedance		100		Ω	
	Return Loss	9.1	11.9		dB	
	Insertion Loss*		1.30	1.64	dB	
	Amplitude Balance		0.55	0.80	dB	
	Phase Balance		2.66	4.67	Degrees	
	CMRR		28.7	24	dB	
	Power Handling			2	Watts	
	Operating Temperature		-55		+85	°C

* Insertion Loss stated at room temperature (Insertion Loss is approximately 0.1 dB higher at +85 °C)

Outline Drawing

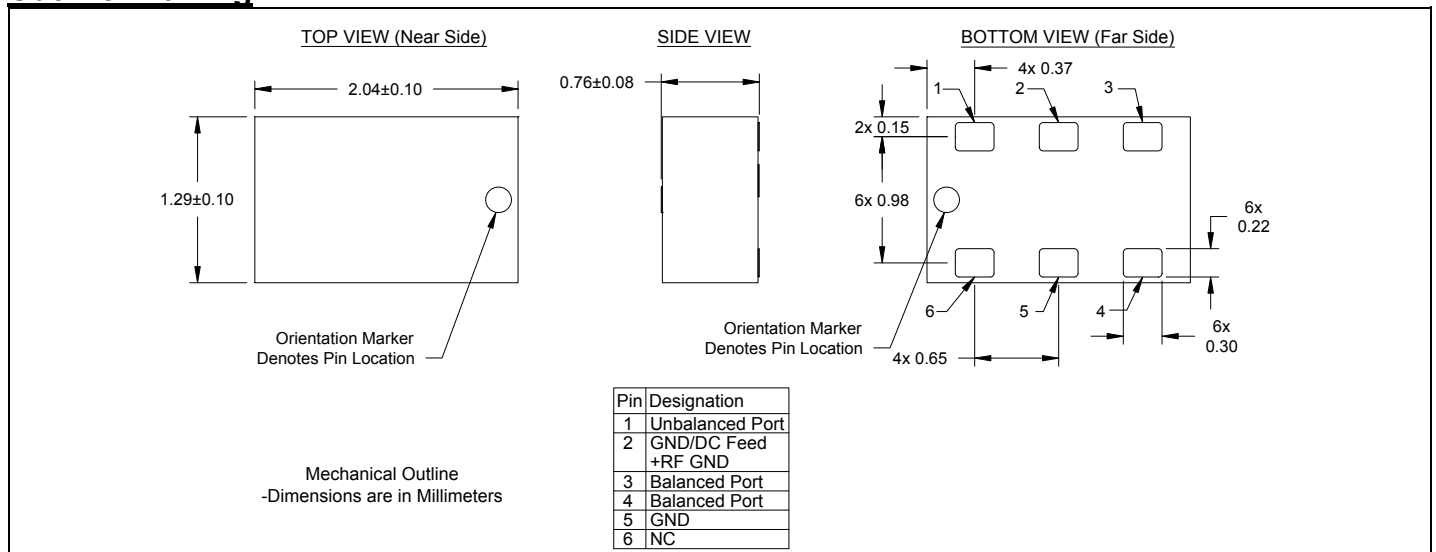

Typical Performance: 800 MHz to 2.3 GHz.

Return Loss - Input

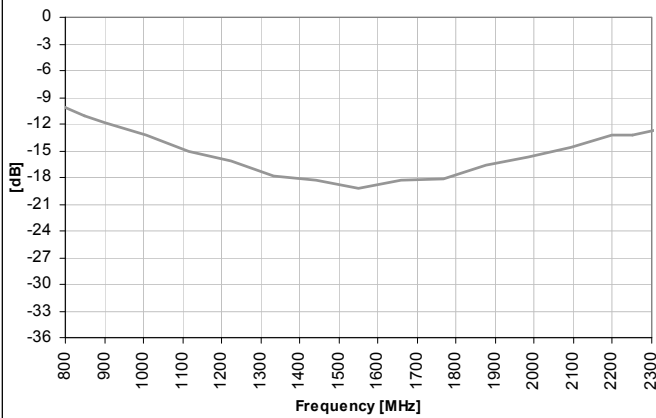

Insertion Loss

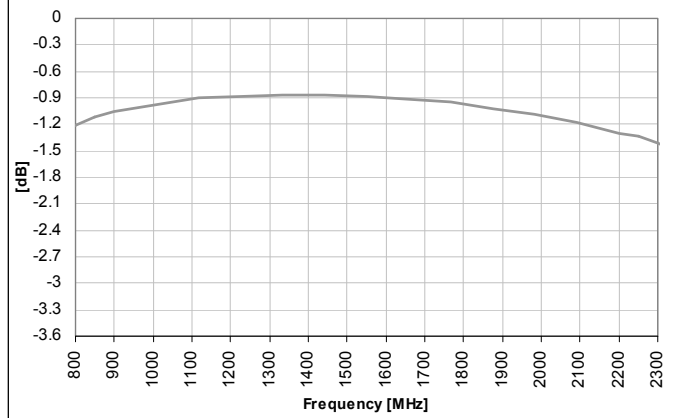

Amplitude Balance

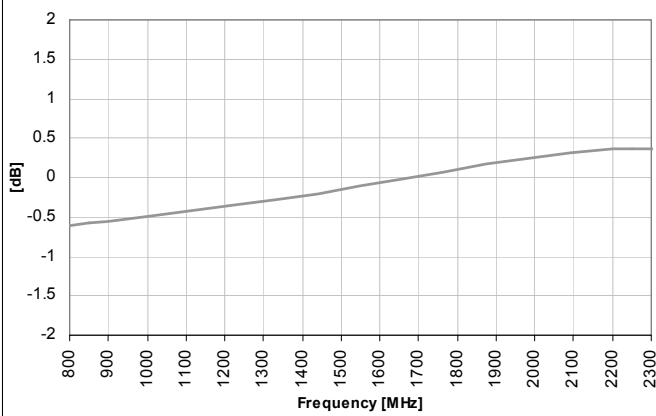

Phase Balance

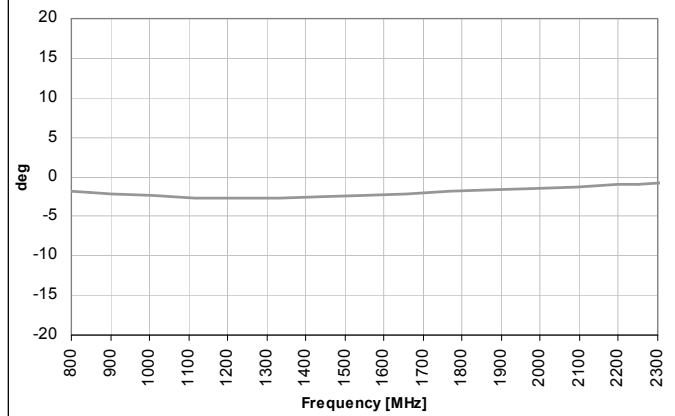

CMRR

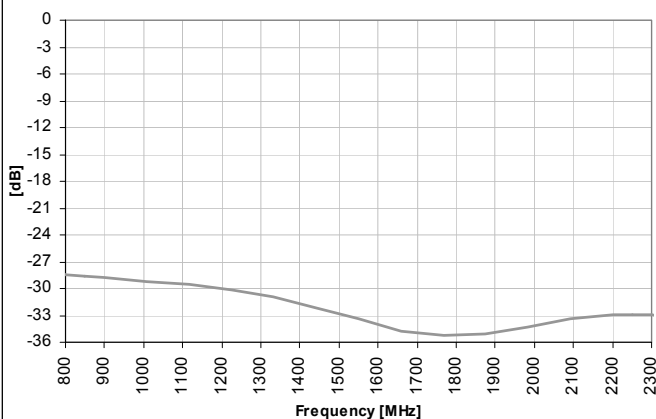

Typical Broadband Performance: 500 MHz. to 8.5 GHz.

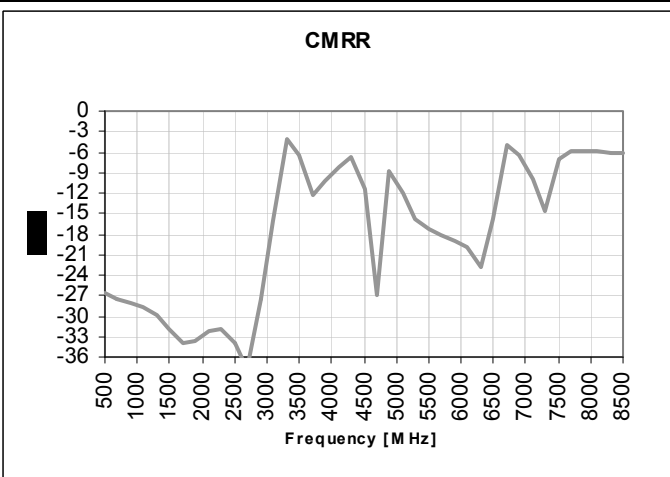
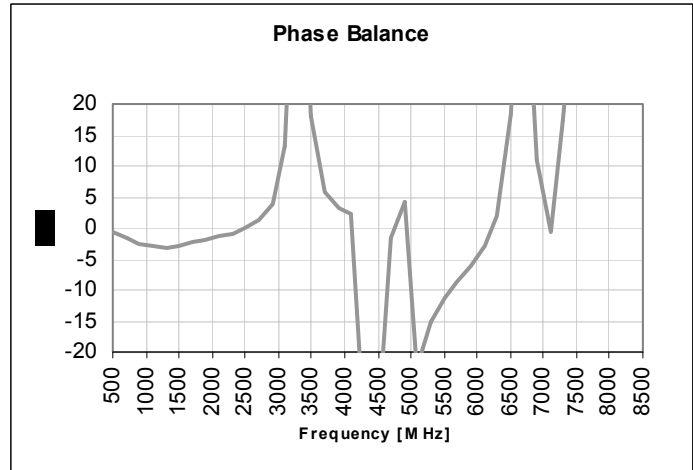
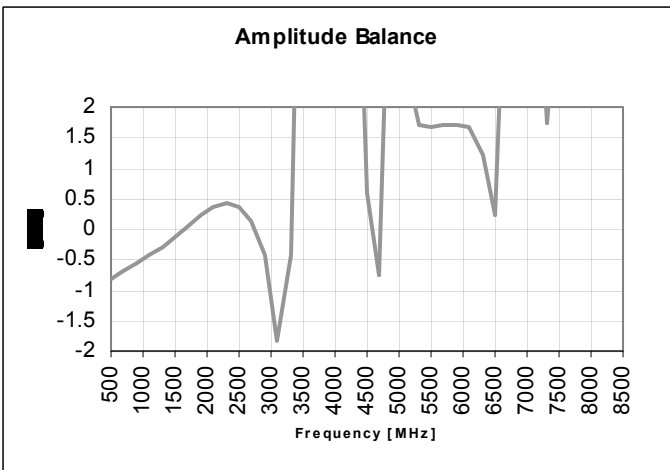
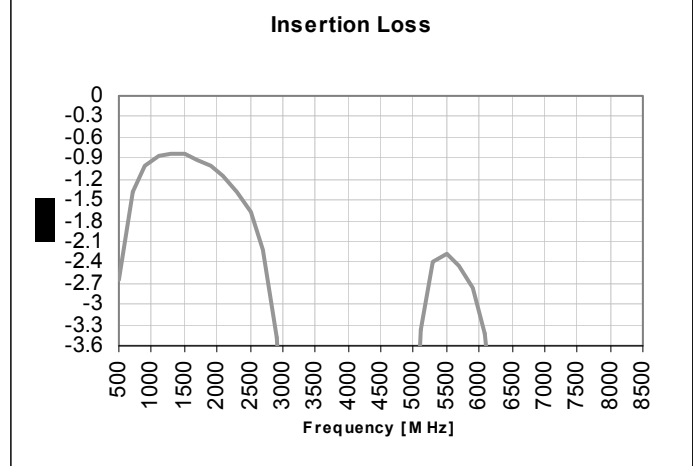
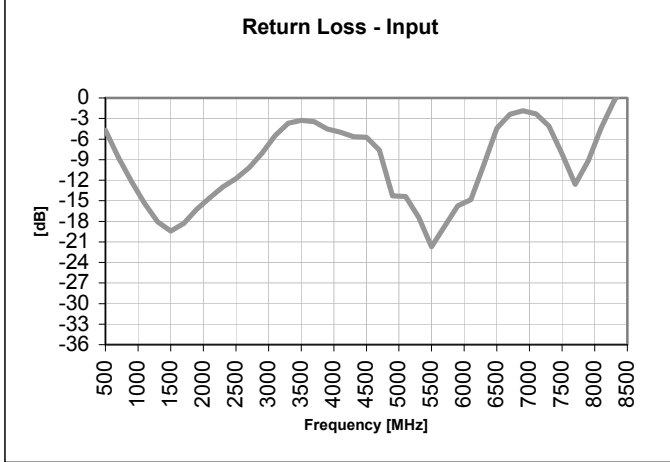

Mounting Configuration:

In order for Xinger surface mount components to work optimally, the proper impedance transmission lines must be used to connect to the RF ports. If this condition is not satisfied, insertion loss, Isolation and VSWR may not meet published specifications.

All of the Xinger components are constructed from organic PTFE based composites which possess excellent electrical and mechanical stability. Xinger components are compliant to a variety of ROHS and Green standards and ready for Pb-free soldering processes. Pads are Gold plated with a Nickel barrier.

An example of the PCB footprint used in the testing of these parts is shown below. In specific designs, the transmission line widths need to be adjusted to the unique dielectric coefficients and thicknesses as well as varying pick and place equipment tolerances.

No Bias Footprint

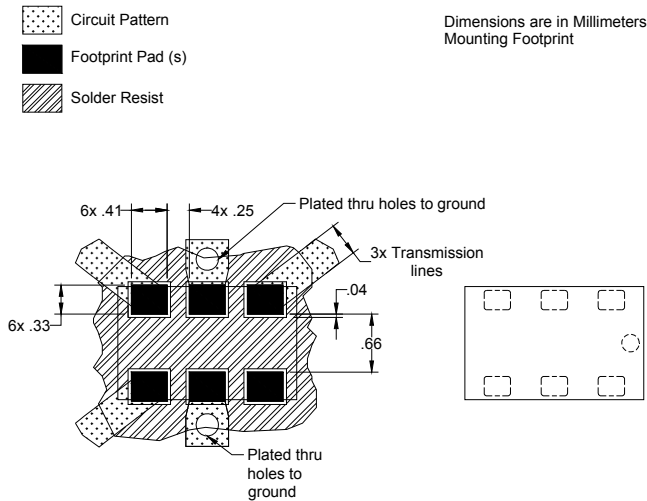

DC Bias Footprint

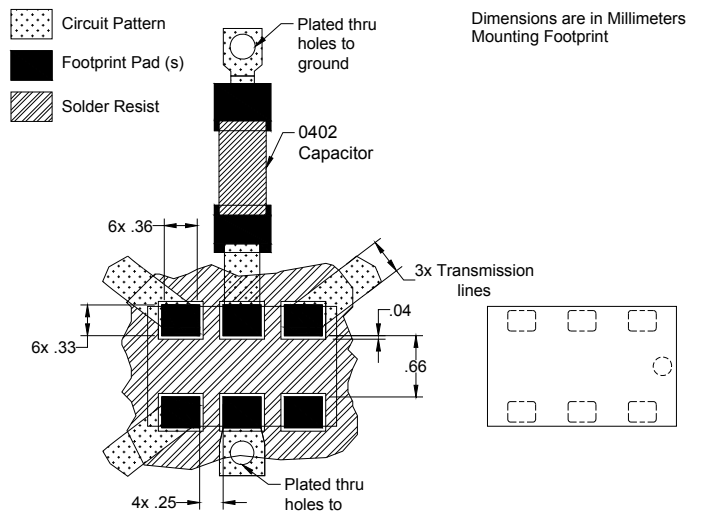

Packaging and Ordering Information

Parts are available in reel and are packaged per EIA 481-2. Parts are oriented in tape and reel as shown below. Minimum order quantities are 4000 per reel. See Model Numbers below for further ordering information.

