

DATA SHEET

SKY13348-374LF: 0.5 to 6.0 GHz SPDT Switch, 50 Ω Terminated

Applications

- WiMAX 802.16
- WLAN 802.11 a/b/g/n

Features

- 50 Ω terminated RF outputs from 0.5 to 6.0 GHz
- Low insertion loss: 0.6 dB @ 2.5 GHz
- High isolation: 27 dB @ 2.5 GHz
- IP1dB: +37 dBm
- Small, MLPD (6-pin, 1.5 x 1.5 mm) package (MSL1, 260 °C per JEDEC J-STD-020)



Skyworks Green™ products are compliant with all applicable legislation and are halogen-free. For additional information, refer to *Skyworks Definition of Green™*, document number SQ04-0074.

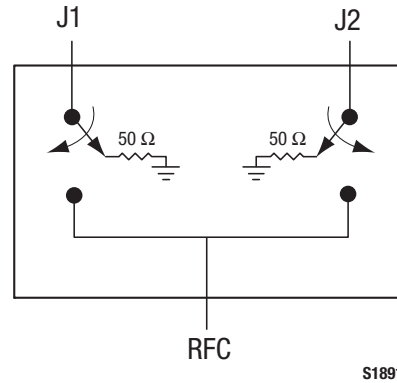

Figure 1. SKY13348-374LF Block Diagram

Description

The SKY13348-374LF is a pHEMT GaAs Single-Pole, Double-Throw (SPDT) high power switch with 50 Ω terminated outputs. The high linearity performance and low insertion loss achieved by the SKY13348-374LF make it an ideal choice for WiMAX and WLAN applications such as 802.11 a/b/g/n where low loss, high isolation, and excellent linearity are key requirements.

The switch is manufactured in a compact, 1.5 x 1.5 mm, 6-pin exposed pad plastic Micro Leadframe Package Dual (MLPD) package.

A functional block diagram is shown in Figure 1. The pin configuration and package are shown in Figure 2. Signal pin assignments and functional pin descriptions are provided in Table 1.

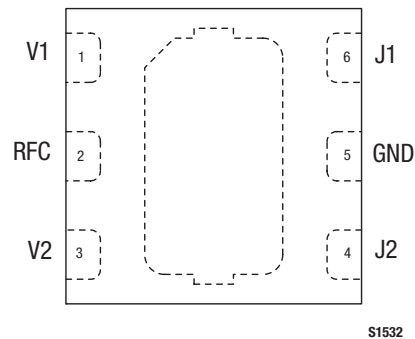

Figure 2. SKY13348-374LF Pinout – 6-Pin MLPD (Top View)

Table 1. SKY13348-374LF Signal Descriptions

Pin #	Name	Description	Pin #	Name	Description
1	V1	DC control voltage. A logic high voltage enables an insertion loss path between the RFC and J1 pins.	4	J2	RF output: 50 Ω terminated when in isolation state. Must be DC blocked.
2	RFC	RF common input. Must be DC blocked.	5	GND	Ground
3	V2	DC control voltage. A logic high voltage enables an insertion loss path between the RFC and J2 pins.	6	J1	RF output: 50 Ω terminated when in isolation state. Must be DC blocked.

Table 2. SKY13348-374LF Absolute Maximum Ratings

Parameter	Symbol	Minimum	Typical	Maximum	Units
Control voltage	V _{CTL}			6	V
Input power	P _{IN}			+38	dBm
Storage temperature	T _{STG}	-40		+125	°C
Operating temperature	T _{OP}	-40		+85	°C

Note: Exposure to maximum rating conditions for extended periods may reduce device reliability. There is no damage to device with only one parameter set at the limit and all other parameters set at or below their nominal value. Exceeding any of the limits listed here may result in permanent damage to the device.

CAUTION: Although this device is designed to be as robust as possible, Electrostatic Discharge (ESD) can damage this device. This device must be protected at all times from ESD. Static charges may easily produce potentials of several kilovolts on the human body or equipment, which can discharge without detection. Industry-standard ESD precautions should be used at all times.

Functional Description

The SKY13348-374LF symmetric SPDT switch is designed using an advanced 0.5-micron GaAs pHEMT foundry process. The switch features linear power handling up to 7 watts with 50 Ω terminated outputs. Switching is controlled by two control voltage inputs, V1 and V2 (pins 1 and 3, respectively). Depending on the logic voltage level applied to the control pins, the RFC pin is connected to one of the two switched RF outputs, J1 or J2, using a low insertion loss path, while the path between the RFC pin and the other RF pin is in a high isolation state.

DC blocking capacitors are required on all RF ports of the switch, and determine the lower frequency return loss and insertion loss of the insertion loss state. The off RF output is internally terminated to 50 Ω. The low frequency impedance is determined by an on-chip capacitor and cannot be extended below 500 MHz using external components. The switch is fully operational below 500 MHz. The off port impedance appears as a reflective open. If operated below 100 MHz, the power handling and linearity of the device can be degraded even at high control voltage levels.

If V1 and V2 are biased to both high or low logic levels, the switch appears as a very poor two-way power splitter with low return loss on all RF ports. The switch is not damaged if placed in these

states. In normal switching logic modes, V1 and V2 can be set between 1.8 and 5.0 V.

The SKY13348-374LF is designed for medium to high power, dual-band WLAN, WIMAX, and LTE switching applications. The device can also be used in a variety of other applications that require high performance RF switching. The high P_{0.1dB} and advance proprietary fabrication process enables an exceptional 3rd Order Input Intercept Point (IIP3), Error Vector Magnitude (EVM), and harmonic performance. Excellent insertion loss, return loss, and isolation are maintained up to 6 GHz.

Electrical and Mechanical Specifications

The absolute maximum ratings of the SKY13348-374LF are provided in Table 2. Electrical specifications are provided in Table 3.

Typical performance characteristics of the SKY13348-374LF are illustrated in Figures 3 through 8.

The state of the SKY13348-374LF is determined by the logic provided in Table 4.

Table 3. SKY13348-374LF Electrical Specifications (Note 1)

($V_{CTL} = 0\text{ V}$ and $+3.0\text{ V}$, $T_{OP} = +25\text{ }^{\circ}\text{C}$, $P_{IN} = 0\text{ dBm}$, Characteristic Impedance [Z_0] = $50\text{ }\Omega$, $C_{BLK} = 47\text{ pF}$, Unless Otherwise Noted)

Parameter	Symbol	Test Condition	Min	Typical	Max	Units	
Insertion loss	IL	All paths					
		500 MHz to 2.70 GHz		0.60	0.75	dB	
		2.70 to 3.80 GHz		0.70	0.85	dB	
Isolation	Iso	All paths					
		500 MHz to 2.70 GHz	24	27	dB		
		2.70 to 3.80 GHz	18	24	dB		
Input return loss	IS11I	500 MHz to 6.0 GHz	10	15		dB	
		Output return loss (off port return loss)	IS22I IS33I	All ports			
				2.00 to 2.70 GHz	10	15	dB
3.30 to 3.80 GHz	10			15	dB		
1 dB Input Compression Point	IP1dB	All ports, $V_{CTL} = 3.0\text{ V}$					
		2.30 to 2.70 GHz	+35	+37	dBm		
		3.30 to 3.80 GHz	+35	+37	dBm		
3 rd Order Input Intercept Point	IIP3	All ports, $V_{CTL} = 3.0\text{ V}$					
		2.4 GHz	52	60	dB		
		3.8 GHz	52	60	dB		
Error Vector Magnitude, WLAN	EVM_WLAN	5.8 GHz	52	57	dB		
		Input power for 2.5% error, WLAN 2.45 GHz, 802.11g OFDM, 54 Mbps, 64 QAM, $V_{CTL} = 3.0\text{ V}$	+28	+29		dBm	
			Error Vector Magnitude, WiMAX	EVM_WIMAX	Input power for 2.5% error, WiMAX 5.8 GHz, OFDMA, 64 QAM, $V_{CTL} = 3.0\text{ V}$	+28	+29
2 nd harmonic	2fo				$P_{IN} = +25\text{ dBm}$, $V_{CTL} = 3.0\text{ V}$		
		900 MHz			+75	+80	dBc
		1.8 GHz	+75	+80	dBc		
3 rd harmonic	3fo	2.4 GHz	+75	+80	dBc		
		3.8 GHz	+75	+80	dBc		
		5.8 GHz	+69	+80	dBc		
Switching speed:	t_{ON} t_{OFF}	$P_{IN} = +25\text{ dBm}$, $V_{CTL} = 3.0\text{ V}$					
		900 MHz	+75	+80	dBc		
		1.8 GHz	+70	+80	dBc		
On	t_{ON}	2.4 GHz	+69	+75	dBc		
		3.8 GHz	+63	+71	dBc		
		5.8 GHz	+75	+80	dBc		
Off	t_{OFF}	50% control to 90% RF		100	250	ns	
		50% control to 10% RF		50	250	ns	

Note 1: Performance is guaranteed only under the conditions listed in this Table.

Typical Performance Characteristics

($V_{CTL} = 0\text{ V}$ and $+3.0\text{ V}$, $T_{OP} = +25\text{ }^{\circ}\text{C}$, $P_{IN} = 0\text{ dBm}$, Characteristic Impedance [Z_0] = $50\ \Omega$, $C_{BLK} = 47\text{ pF}$, Unless Otherwise Noted)

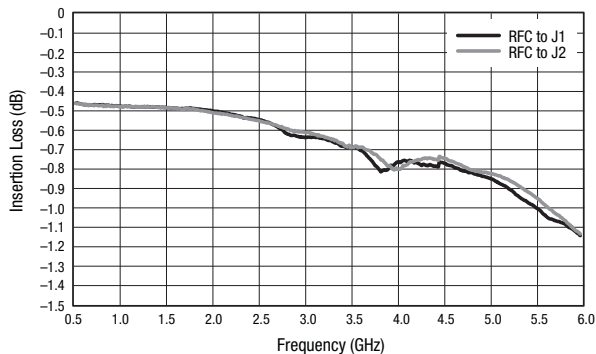

Figure 3. Insertion Loss vs Frequency

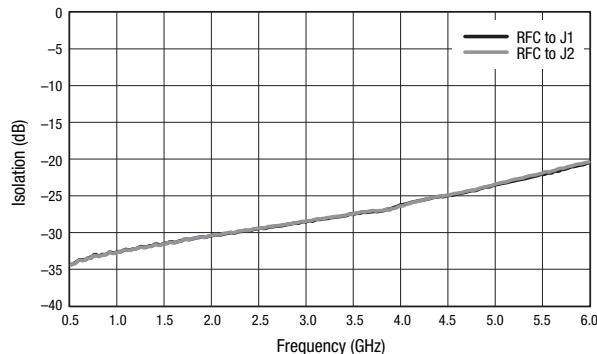

Figure 4. Isolation vs Frequency

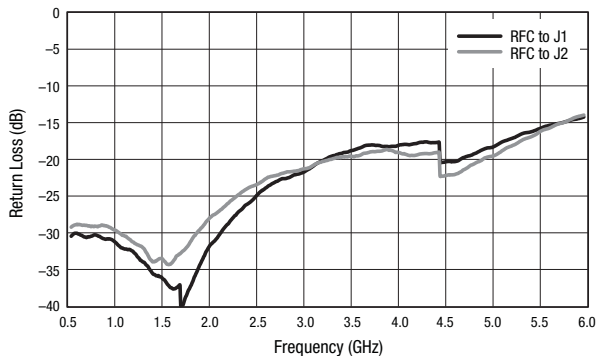

Figure 5. Return Loss vs Frequency, On Ports

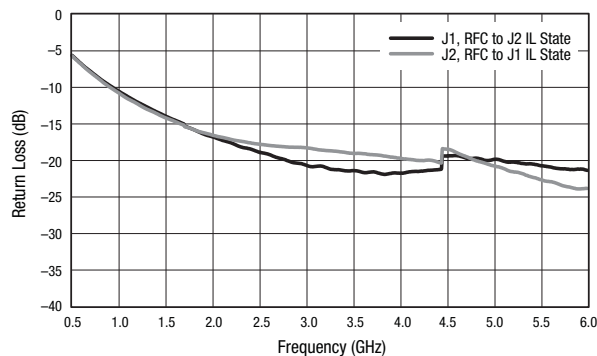

Figure 6. Return Loss vs Frequency, Off Ports

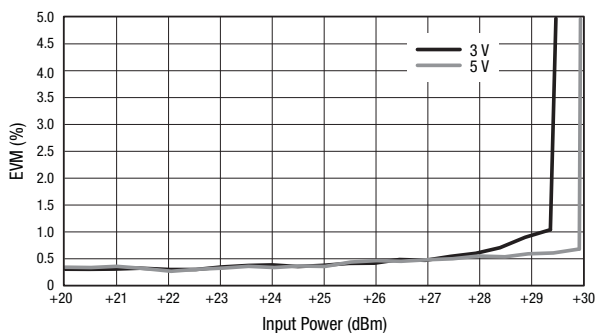

Figure 7. EVM vs Input Power
(WiMAX 802.16 64 QAM OFDMA, $f = 3.8\text{ GHz}$)

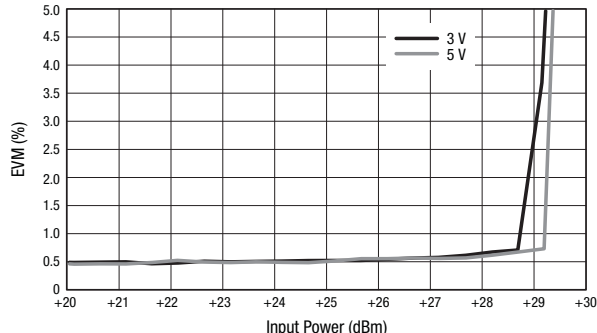

Figure 8. EVM vs Input Power
(802.11g 64 QAM, 54 Mbps, $f = 2.45\text{ GHz}$)

Table 4. SKY13348-374LF Truth Table

V1 (Pin 1)	V2 (Pin 3)	Insertion Loss State
1	0	RFC to J1
0	1	RFC to J2
1	1	undefined
0	0	undefined

Note: "1" = +2.5 V to +5.0 V. "0" = 0 V to +0.2 V. Any state other than described in this Table places the switch into an undefined state. An undefined state will not damage the device.

Evaluation Board Description

The SKY13348-374LF Evaluation Board is used to test the performance of the SKY13348-374LF SPDT Switch. An Evaluation Board schematic diagram is provided in Figure 9. An assembly drawing for the Evaluation Board is shown in Figure 10.

Package Dimensions

The PCB layout footprint for the SKY13348-374LF is provided in Figure 11. Typical case markings are shown in Figure 12. Package dimensions for the 6-pin MLPD are shown in Figure 13, and tape and reel dimensions are provided in Figure 14.

Package and Handling Information

Instructions on the shipping container label regarding exposure to moisture after the container seal is broken must be followed. Otherwise, problems related to moisture absorption may occur when the part is subjected to high temperature during solder assembly.

The SKY13348-374LF is rated to Moisture Sensitivity Level 1 (MSL1) at 260 °C. It can be used for lead or lead-free soldering.

Care must be taken when attaching this product, whether it is done manually or in a production solder reflow environment. Production quantities of this product are shipped in a standard tape and reel format.

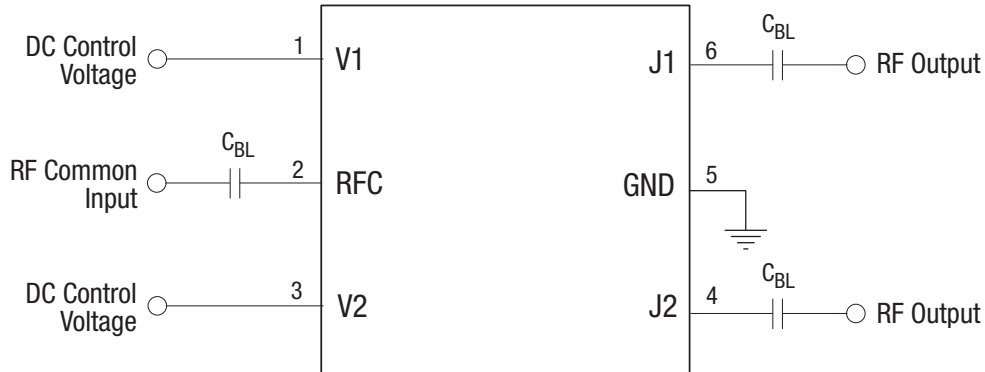

C_{BL} = 47 pF for >1 GHz operation. Increase value for lower frequency operation.

Exposed ground paddle should be grounded for best performance.

S1545a

Figure 9. SKY13348-374LF Evaluation Board Schematic

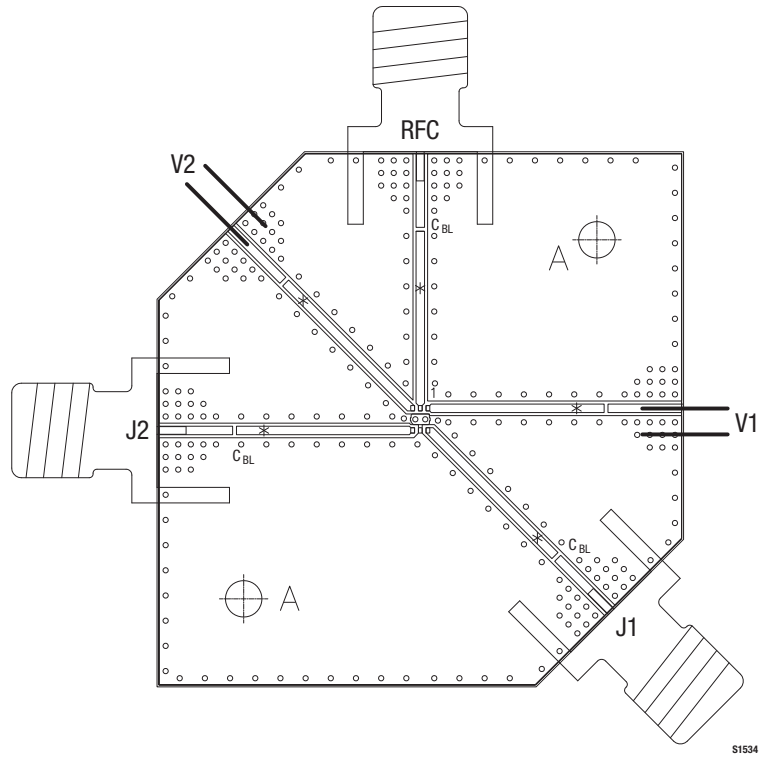

Figure 10. SKY13348-374LF Evaluation Board Assembly Diagram

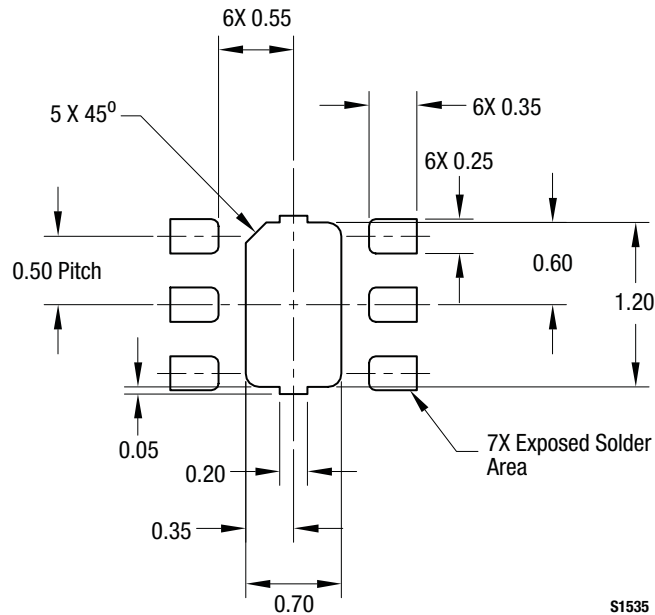

Figure 11. SKY13348-374LF PCB Layout Footprint (Top View)

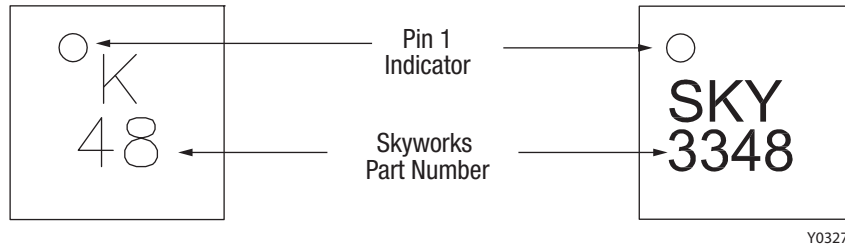
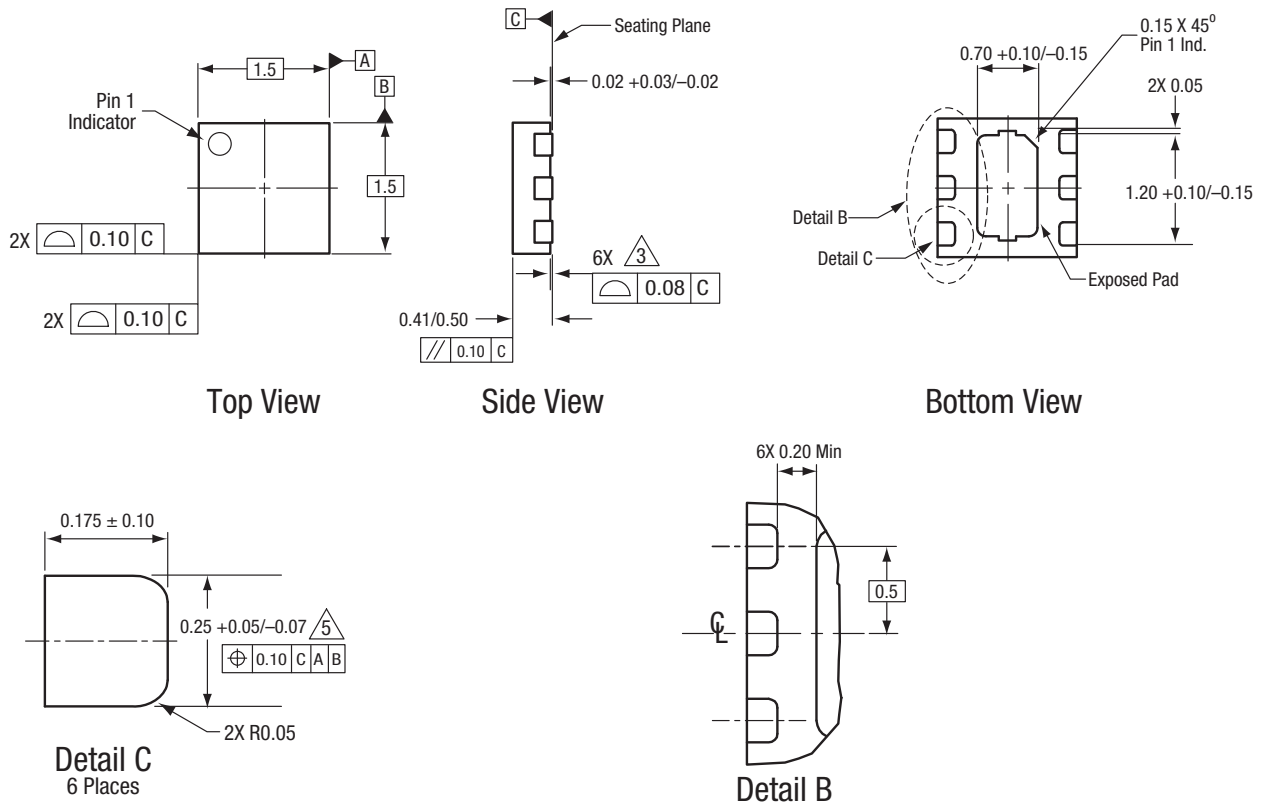

Figure 12. Typical Part Markings (Top View)



All measurements are in millimeters.
 Dimensioning and tolerancing according to ASME Y14.5M-1994.
 Coplanarity applies to the exposed heat sink slug as well as the terminals.
 Plating requirement per source control drawing (SCD) 2504.
 Dimension applies to metalized terminal and is measured between 0.15 mm and 0.30 mm from terminal tip.

S1536

Figure 13. SKY13348-374LF 6-Pin QFN Package Dimensions

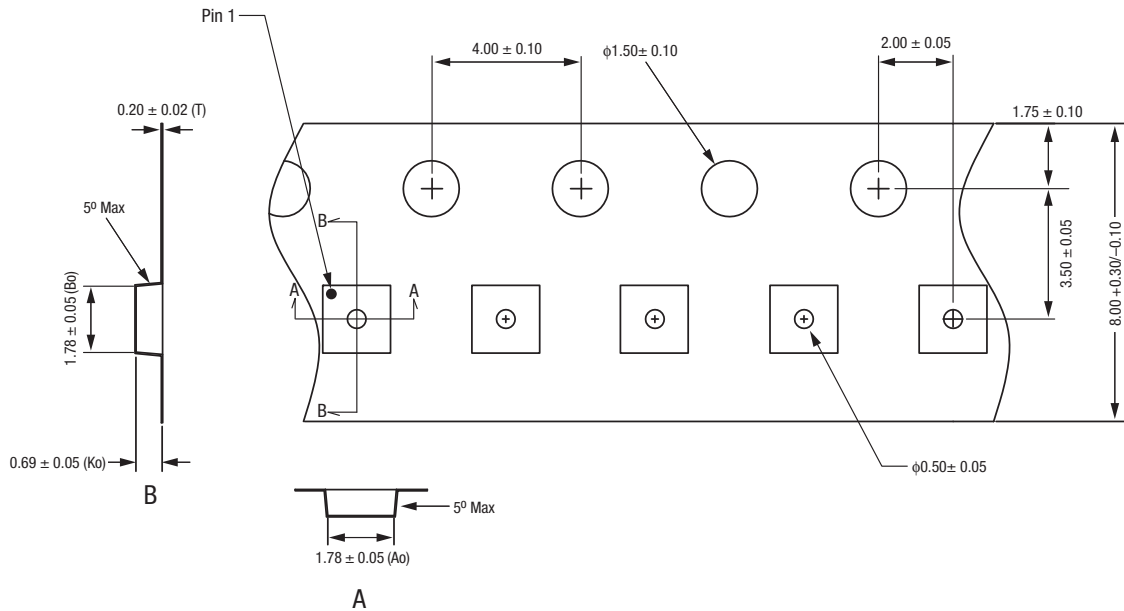

- Notes:
1. Carrier tape: black conductive polycarbonate or polystyrene.
 2. Cover tape material: transparent conductive PSA.
 3. Cover tape size: 5.4 mm width.
 4. All measurements are in millimeters.

S1382a

Figure 14. SKY13348-374LF Tape and Reel Dimensions

Ordering Information

Model Name	Manufacturing Part Number	Evaluation Kit Part Number
SKY13348-374LF SPDT Switch	SKY13348-374LF	SKY13348-374LF-EVB

Copyright © 2010, 2012-2013 Skyworks Solutions, Inc. All Rights Reserved.

Information in this document is provided in connection with Skyworks Solutions, Inc. (“Skyworks”) products or services. These materials, including the information contained herein, are provided by Skyworks as a service to its customers and may be used for informational purposes only by the customer. Skyworks assumes no responsibility for errors or omissions in these materials or the information contained herein. Skyworks may change its documentation, products, services, specifications or product descriptions at any time, without notice. Skyworks makes no commitment to update the materials or information and shall have no responsibility whatsoever for conflicts, incompatibilities, or other difficulties arising from any future changes.

No license, whether express, implied, by estoppel or otherwise, is granted to any intellectual property rights by this document. Skyworks assumes no liability for any materials, products or information provided hereunder, including the sale, distribution, reproduction or use of Skyworks products, information or materials, except as may be provided in Skyworks Terms and Conditions of Sale.

THE MATERIALS, PRODUCTS AND INFORMATION ARE PROVIDED “AS IS” WITHOUT WARRANTY OF ANY KIND, WHETHER EXPRESS, IMPLIED, STATUTORY, OR OTHERWISE, INCLUDING FITNESS FOR A PARTICULAR PURPOSE OR USE, MERCHANTABILITY, PERFORMANCE, QUALITY OR NON-INFRINGEMENT OF ANY INTELLECTUAL PROPERTY RIGHT; ALL SUCH WARRANTIES ARE HEREBY EXPRESSLY DISCLAIMED. SKYWORKS DOES NOT WARRANT THE ACCURACY OR COMPLETENESS OF THE INFORMATION, TEXT, GRAPHICS OR OTHER ITEMS CONTAINED WITHIN THESE MATERIALS. SKYWORKS SHALL NOT BE LIABLE FOR ANY DAMAGES, INCLUDING BUT NOT LIMITED TO ANY SPECIAL, INDIRECT, INCIDENTAL, STATUTORY, OR CONSEQUENTIAL DAMAGES, INCLUDING WITHOUT LIMITATION, LOST REVENUES OR LOST PROFITS THAT MAY RESULT FROM THE USE OF THE MATERIALS OR INFORMATION, WHETHER OR NOT THE RECIPIENT OF MATERIALS HAS BEEN ADVISED OF THE POSSIBILITY OF SUCH DAMAGE.

Skyworks products are not intended for use in medical, lifesaving or life-sustaining applications, or other equipment in which the failure of the Skyworks products could lead to personal injury, death, physical or environmental damage. Skyworks customers using or selling Skyworks products for use in such applications do so at their own risk and agree to fully indemnify Skyworks for any damages resulting from such improper use or sale.

Customers are responsible for their products and applications using Skyworks products, which may deviate from published specifications as a result of design defects, errors, or operation of products outside of published parameters or design specifications. Customers should include design and operating safeguards to minimize these and other risks. Skyworks assumes no liability for applications assistance, customer product design, or damage to any equipment resulting from the use of Skyworks products outside of stated published specifications or parameters.

Skyworks, the Skyworks symbol, and “Breakthrough Simplicity” are trademarks or registered trademarks of Skyworks Solutions, Inc., in the United States and other countries. Third-party brands and names are for identification purposes only, and are the property of their respective owners. Additional information, including relevant terms and conditions, posted at www.skyworksinc.com, are incorporated by reference.