

Alle Rechte vorbehalten/ All rights reserved

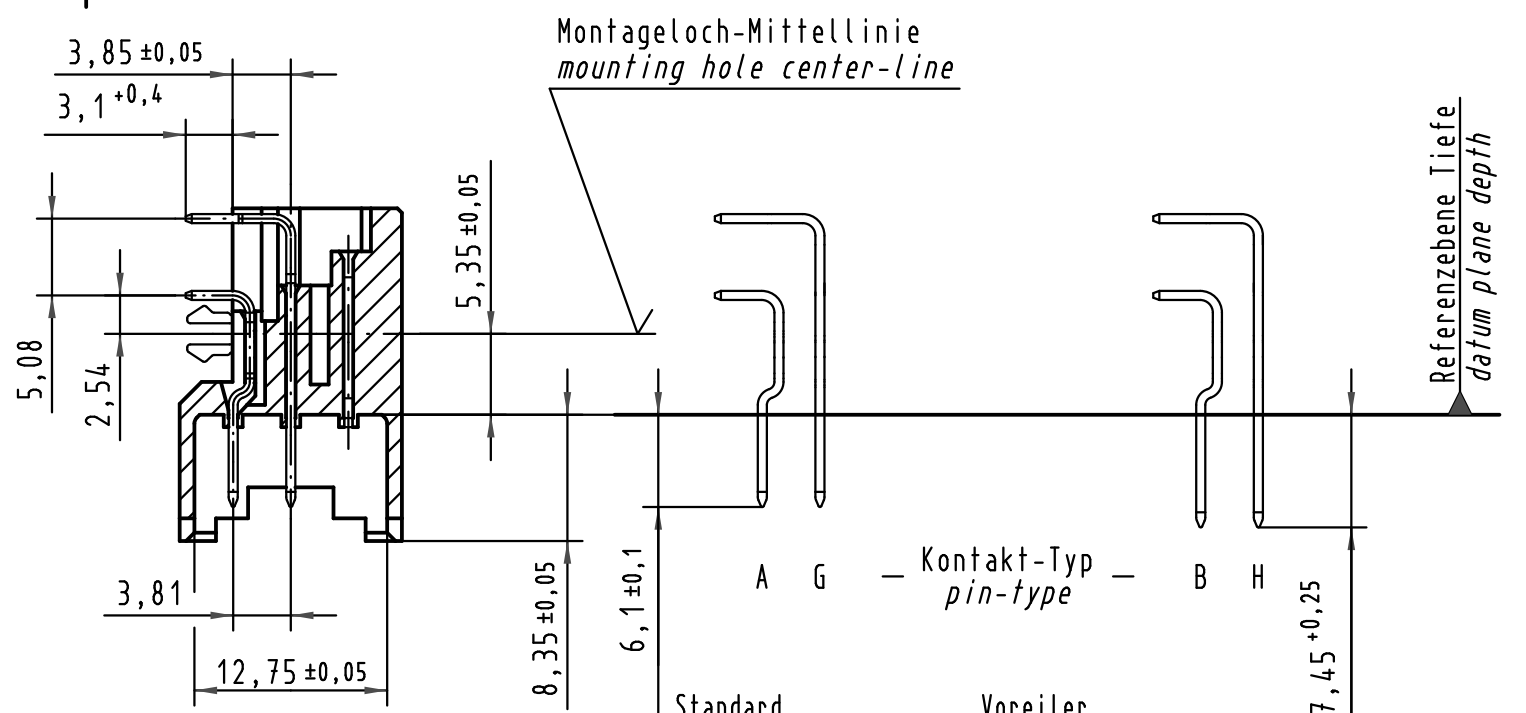

A-B
2:1

X Kontaktbelegung
contact loading

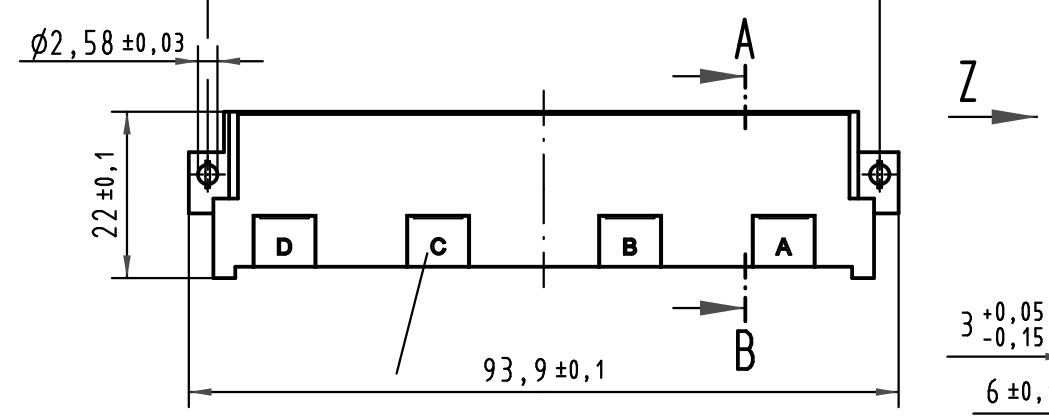
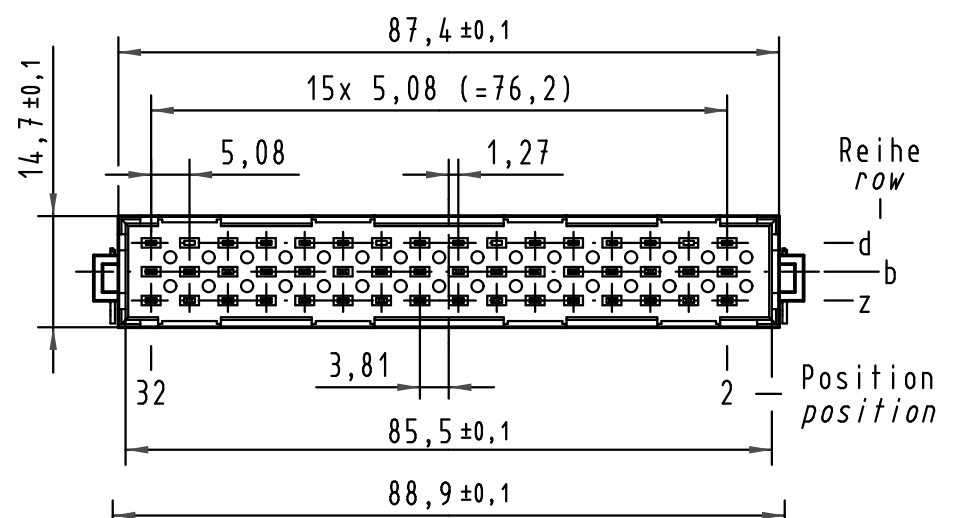
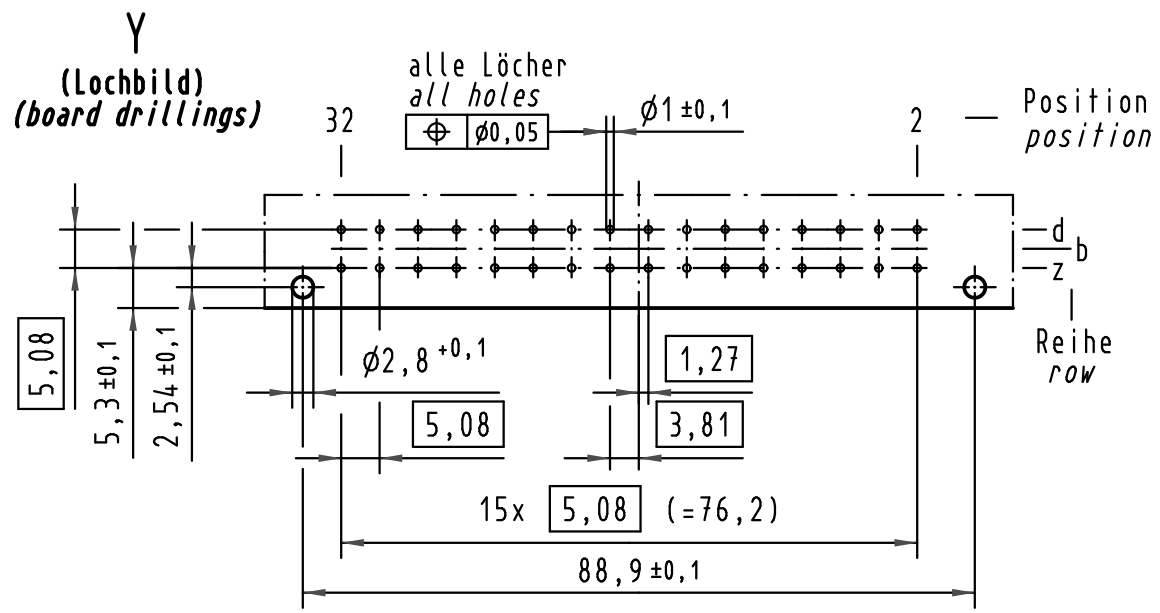
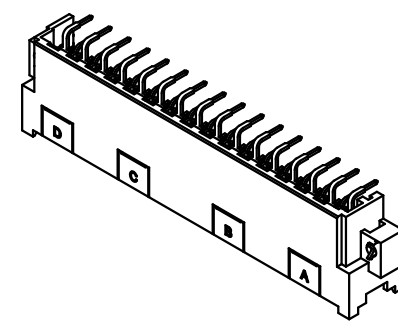
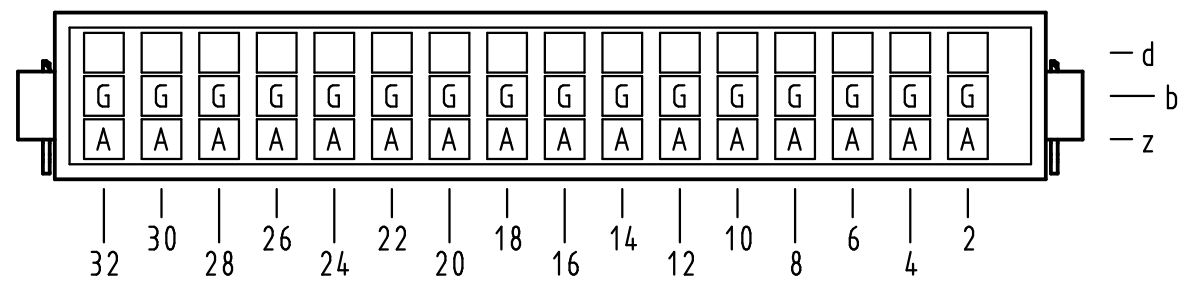

09 06 332 7901	3	Au flash over PdNi over Ni
Bestell-Nr. part-no.	Anforderungsstufe nach IEC performance level acc. to IEC	Kontaktoberfläche contact plating

Z
10:1

Querschnitt der Lötanschlüsse:
cross-section of solder terminations:

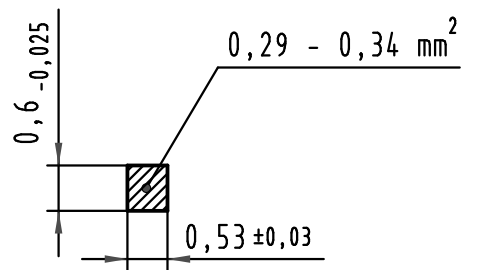

All Dimensions in mm Original Size DIN A 3			Techn. Character.			Nicht tolerierte Maße/Free size tolerances IEC 60603-2					
						type F male connector with clip solder angled 5,08 32 pol.					
									1:1 (2:1; 10:1)		
35260	09.09.08	Hage.							TB 09 06 332 x901		
33149	04.11.05	Hage.									
30801											
Mod.	Dat.	Name	HARTING Electronics GmbH & Co. KG D-32339 ESPELKAMP			Blatt/ page Sub.					