

THIS DOCUMENT IS THE PROPERTY OF
KEYSTONE ELECTRONICS CORP. AND
SHALL NOT BE REPRODUCED, DISTRIBUTED
OR USED AS A BASIS FOR MANUFACTURE
WITHOUT PRIOR WRITTEN PERMISSION
FROM KEYSTONE ELECTRONICS CORP.

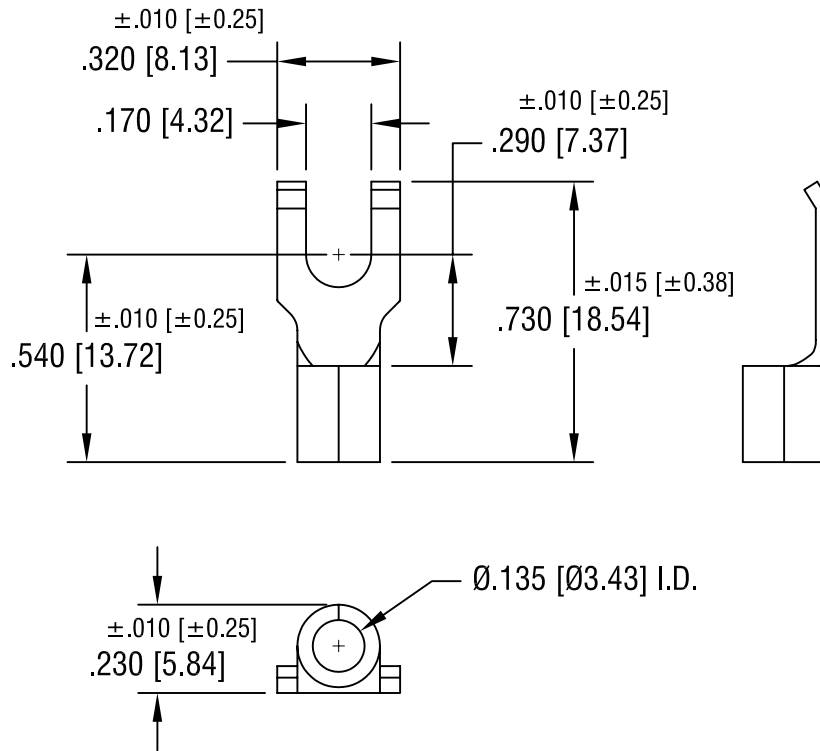

NOTE:

1. ACCOMMODATES WIRE RANGE 12/10 AWG

KEYSTONE ELECTRONICS CORP.			
ASTORIA, N.Y. 11105-2017			
PART NAME			
FLANGED BLOCK SPADE TERMINAL			
MATERIAL			
.040 [1.02] TH'K COPPER			
FINISH		DRN BY	DATE
TIN PLATE		BOONE	10.29.07
		APP'D	SCALE
		LN	2X
TOLERANCES	INCH [MM]	CODE	DWG NO.
DECIMAL	± .005 [± 0.15]	C/M	8243
ANGULAR	± 1°		
UNLESS OTHERWISE SPECIFIED			

DATE	DESCRIPTION	REV.