



## Open Network for High-Speed Control



### High Speed Sensor & Actuator Network

- » Extremely Fast Communications
- » Powerful Diagnostic Information
- » Simple Installation & Low Cost Solutions



# Key Features and Benefits



## Extremely Fast Communications

- » Over 1000 I/O update in 1 ms
- » Fast I/O updates can allow for higher production rates in less time, saving time and lowering costs.

## Powerful Diagnostic Information with Smart Slaves

Preventative maintenance & diagnostic information built into the Smart Slaves save time and money by maximizing Up-time and minimizing downtime.

## Simple Installation & Low Cost Solutions

Flat cable allows for easy One-Touch Installation, installation time is 1/30 required time for other systems. The slave nodes automatically match baud rate with the master saving set-up time.

# Other Key Features and Benefits:

## Maintenance data logging minimizes downtime

All SmartSlice I/O units automatically collect and store the information that will help you plan machine maintenance. Timely detection of reduced performance will minimize unplanned downtime and keep machine performance fast and reliable.

## Early-warning system prevents breakdowns

Every CompoNet Slave unit has its own built-in early-warning functions, enabling you to schedule maintenance and prevent breakdowns.

Warnings include:

- » Supply voltage out of safe range – e.g. due to damaged cable or poor connection.
- » Preset maintenance interval exceeded – which can be a time interval or a target number of operations, to indicate that an inspection of (electro)mechanical parts is required.



- » Maximum allowed delay between two I/O signals is exceeded – to indicate that wear or lack of lubrication is causing a machine to work slower than intended.

## Smart I/O to reduce your programming effort

Analog I/O units will also help you reduce PLC programming. Many useful functions are already built in, and only require some settings to match your application's characteristics.



## Fast Communication Fast multipoint communication reduces takt times

### Fastest Communication Speeds in the Industry

Provides the fastest communication speeds in the industry for a sensor-actuator level network.

It is possible to send data consisting a large number of control points on multiple nodes. There is no response time delay, even with repeater units.

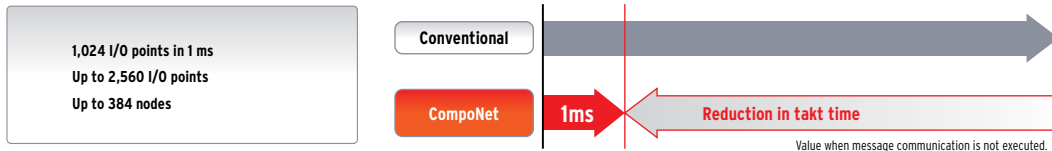

### Fast Communication Technology even at Low Baud Rate of 4 Mbps

Provides excellent performance in applications with large numbers of control points and also in expansion work.

Efficient multicast transmission enables stable and fast communication even when the number of slaves increases.

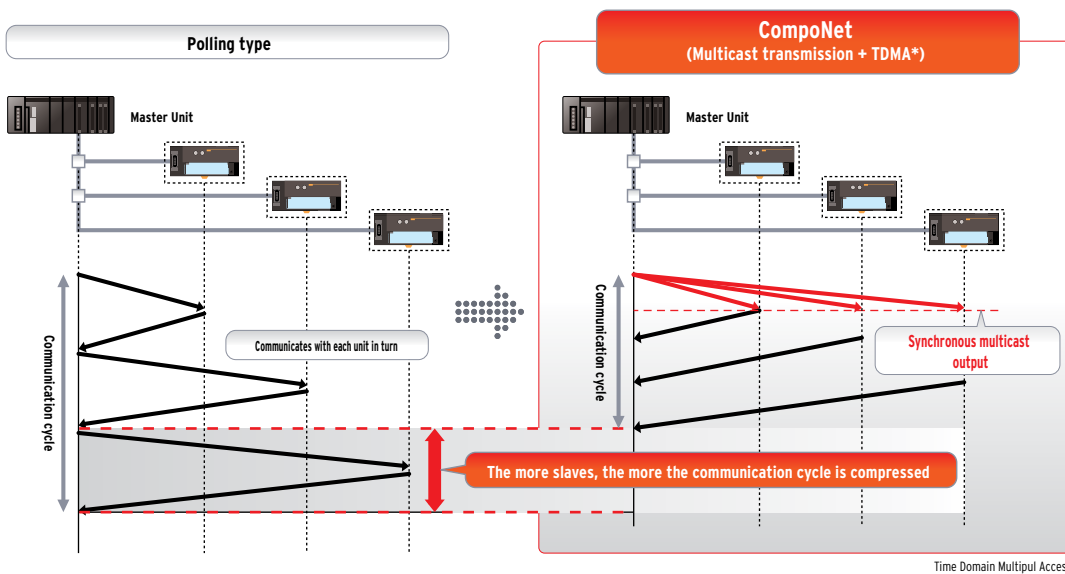

### Advantage of high-speed CompoNet technology

1 Fast communication is maintained even with an increased number of control points.

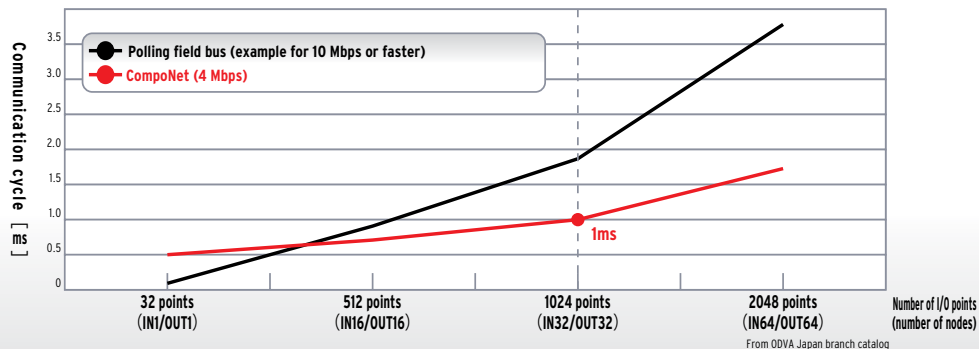

2 Easier wiring (branching is possible even in fast mode)

3 Regular cables can be used.

4 High resistance to noise.

# Simple and Low-Cost Slashes start-up workload and equipment cost!

## Flat Cable for Easy One-Touch Installation

Flat cable shortens installation time.  
It also prevents connector installation mistakes.

- Shield cable for field networks
- 1 Peel away the cable coating.
  - 2 Take out the shield wire.
  - 3 Peel away the lead coating.
  - 4 Attach the 5 crimp terminals.
  - 5 Insert the cable and fasten with 5 screws.



**Flat cable**

**Slashes installation work to 1/30 of the required time!**

- 1 Insert the cable into the connector.
- 2 Snap fit with tool. **Snap**

## Smooth Start-Up with Simple Setup

Just set the master baud rate and the slave node addresses and the system is ready for start-up.  
The slave baud rate is automatically set to match the master unit baud rate.  
The allocation areas are automatically set by the node addresses.

**Automatic recognition of master unit baud rate**

For the slave, just set the node address.

**Rotary switch used**  
Easy-to-understand decimal switch

**Reduces setting mistakes.**

**DIP Switch (hexadecimal)**

\*1. Using CX-Integrator makes detailed settings and monitoring possible.

## Can Use Regular Round Cables for Fast Communication

Regular round cables can be used as the communication cables.

**Conventional network**  
(Shield cable for field networks)

**CompoNet**  
(Round cable)

About 1/5

- Can use regular cables that are inexpensive and easy to find.
- Uses round cables (4-wire) to supply power to the slave units.
- Can also use regular highly flexible cables and oil-resistant cables.
- When communication power is supplied to the slaves, round cables (2-wire) can also be used.

**Round Cable**

\* Use round cables that comply with ODVA specifications.

## Bit-level distribution for effective I/O installation

Bit slaves enable optimum I/O configuration and wiring becomes more efficient.

**Some I/O is not used.**

**Bit slaves enable distributed installation with the optimum numbers.**

## Diagnostic Information Reducing the start-up time and maintenance work

### CX-Integrator Makes Start-Up and Recovery Work More Efficient

CX-Integrator software lets you set the PLC network/serial communication system configuration from a computer. CX-Integrator makes it easy to handle CompoNet assignment, parameter setting, connection state monitoring, comment setting, network diagnosis, etc. from a computer.

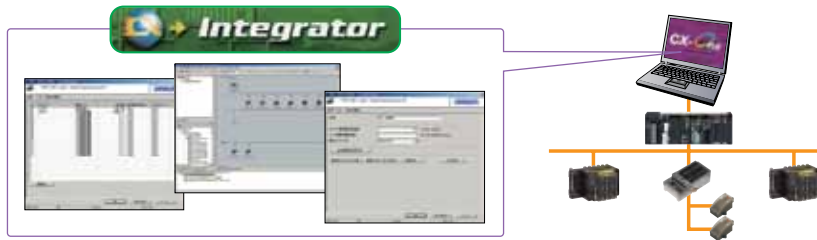

#### Quick discovery of error locations

You can easily check the connection states of all the slaves and quickly specify error contents. You can check errors not only with tools but also with the master LED (7-segment display). This helps make on-site recovery work more efficient.

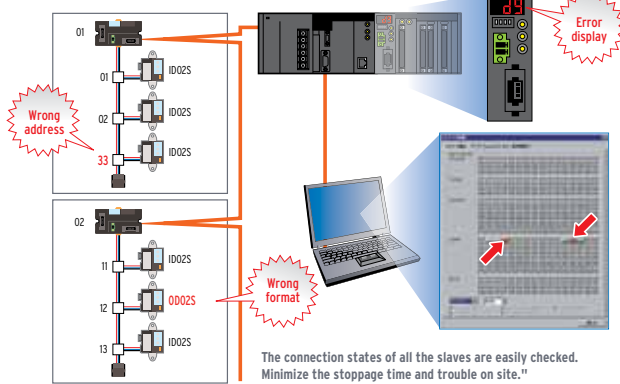

#### Separate an error at a branch destination

When you use a repeater unit, you can display the slaves in each segment and can separate any error beyond the repeater.

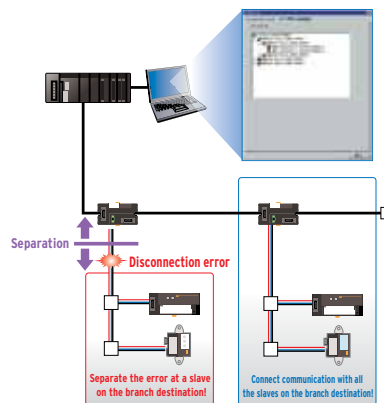

### Informatization of the all Equipment

Smart features are features of the slave main units that collect a variety information used for from start-up to maintenance.

Monitor network power supply voltage with tools and display units. Slaves collect a variety of information helpful for preventive maintenance and detect errors in connected equipment before problems occur. No need to write a program for monitoring.

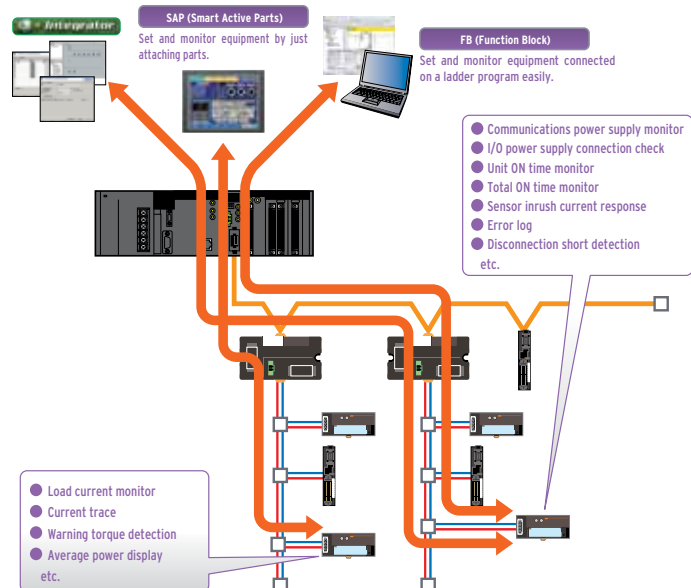

#### Example: Operation time monitor

Slave units collect data on the machine operation time and operation change amount, so you can monitor without increasing the load between controllers.

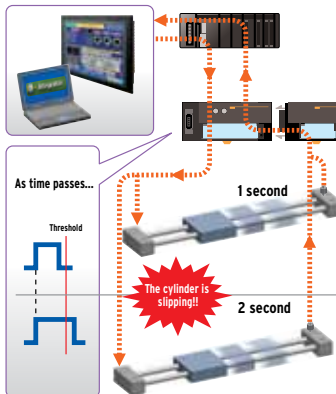

The slave unit counts the machine's ON/OFF repetitions and total operation time to let you know when it is time for maintenance. (Contact operation monitor)



# Wiring Superior branching adaptability reduces wiring work

## Flexible Installation

### Select the best branching method for your application.

CompoNet provides both fast communication and easy wiring. Branch wiring is a powerful tool for installing large numbers of slaves in a variety of locations. You can optimize your cable layout to match the layout of your equipment.

### Distance can easily be extended.

A maximum distance of 1500 m is possible (when baud rate is 93.75 kbps).

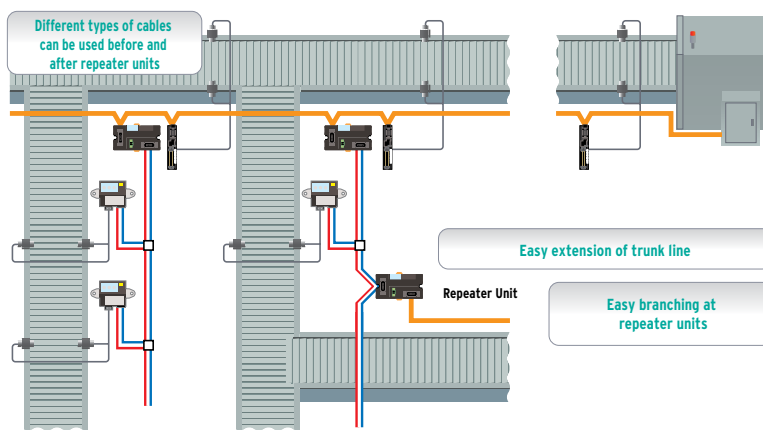

Select the best branching method for your application



Flat Connector Socket + Fat Connector Plug



Multidrop Type



Repeater Unit

### Different types of cables can be mixed.

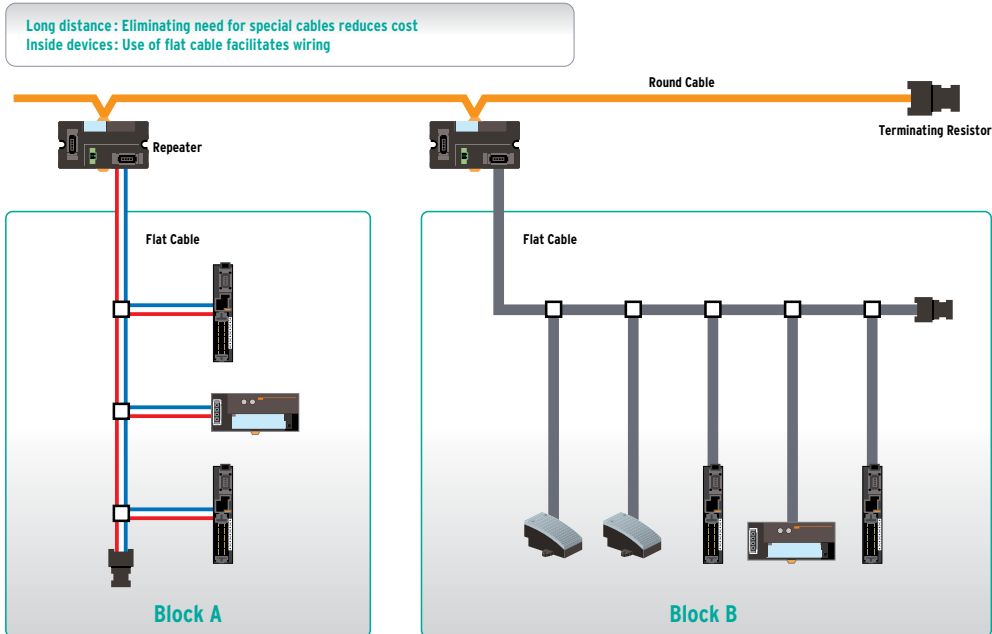

## Network Specifications



CompoNet is made up of segments divided by repeater unit.

There are four CompoNet baud rates, from 4 Mbps ultra-fast mode to 93.75 kbps long-distance mode. The wiring specifications depend on the baud rate. Select the one that best matches your application.

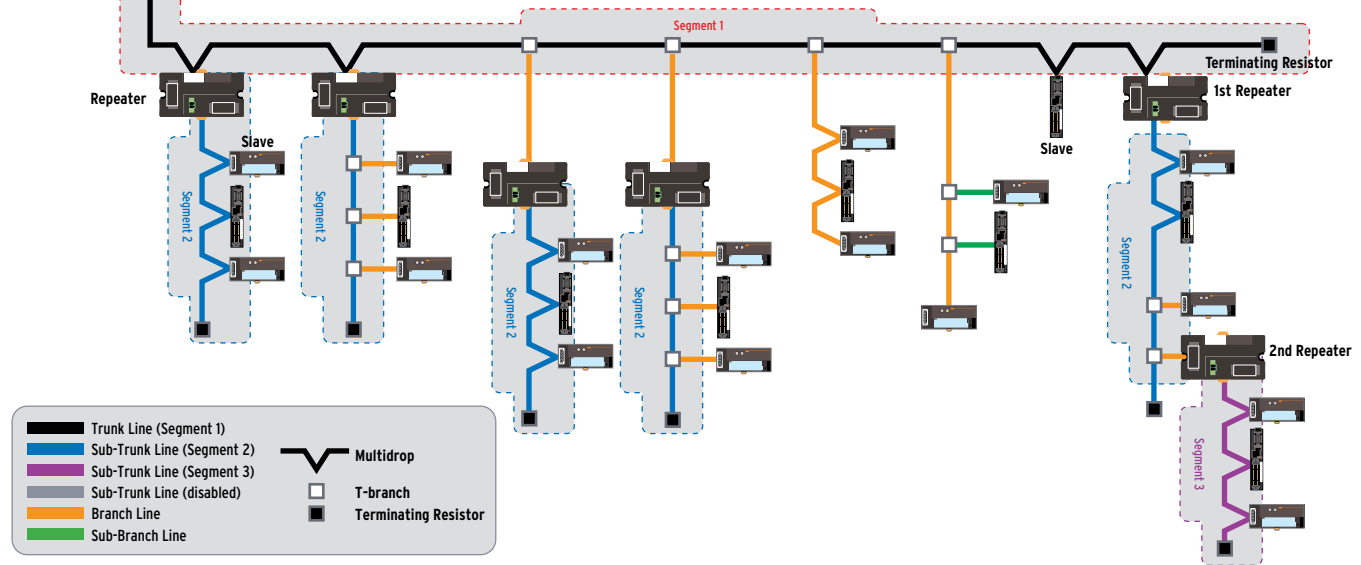

Baud rate	Cable type	Trunk line and sub-trunk line length (When 2 repeaters are used.)	Number of slaves per segment (Including number of repeaters)	Branch line length	Total branch line length per segment	Branch location restrictions	Number of slaves per branch line	Sub-branch line length	Total sub-branch line length per segment
4Mbps	Round cable I, II Flat cable I, II	30m (90m)	32	—	—	—	—	—	—
3Mbps	Round cable I, II Flat cable I, II	30m (90m)	32	0.5m	8m	3/meter	1	—	—
1.5Mbps	Round cable I	Without branches: 100m (300m) With branches: 30m (90m)	32	— 2.5m	— 25m	— 3/meter	— 3	— —	— —
	Round cable II Flat cable I, II	30m (90m)	32	2.5m	25m	3/meter	3	0.1m	2m
93.75kbps	Round cable I Round cable II Flat cable I, II	500m (1500m) 200m (600m)	32	6m	120m	3/meter	1	—	—

200 meter free wiring total wire length per segment

### Example of wiring for 4Mbps baud rate (Application: Ultra-fast communications)

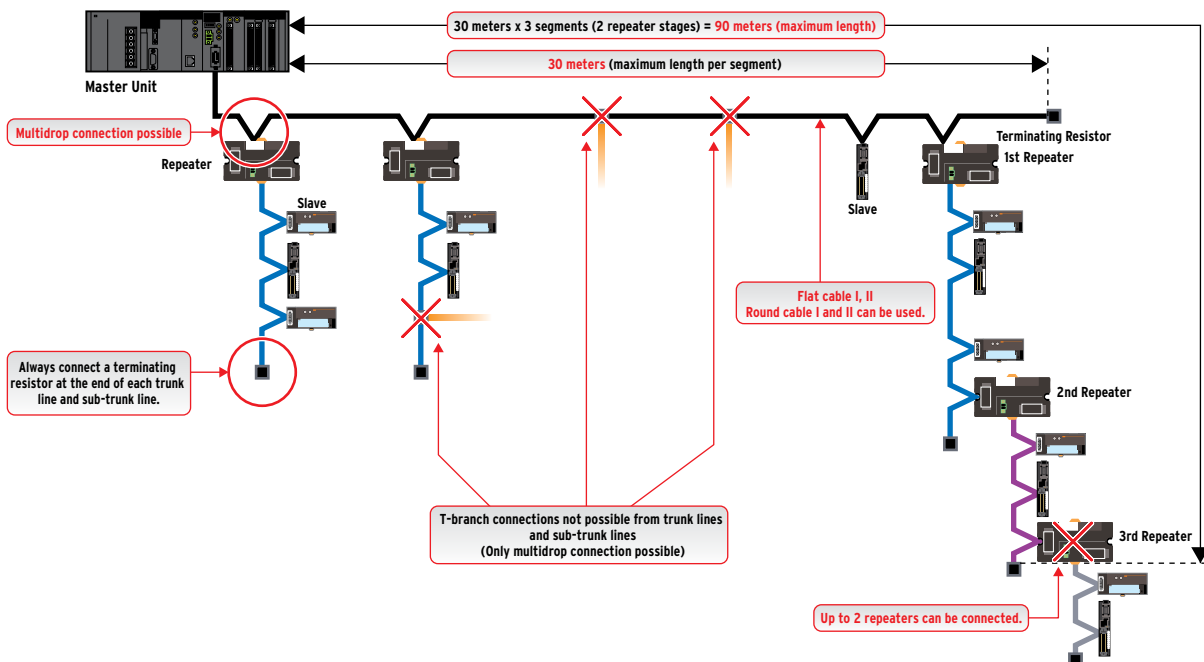



# Network Specifications

Example of wiring for 3Mbps (Application: Fast communications with branching)

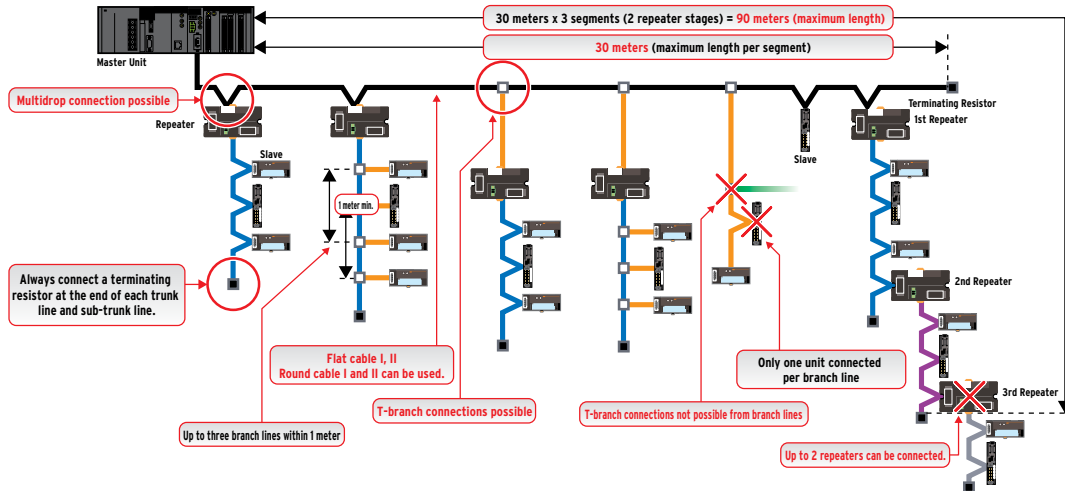

Example of wiring for 1.5 Mbps (Application: Balance of fast communications and branching)

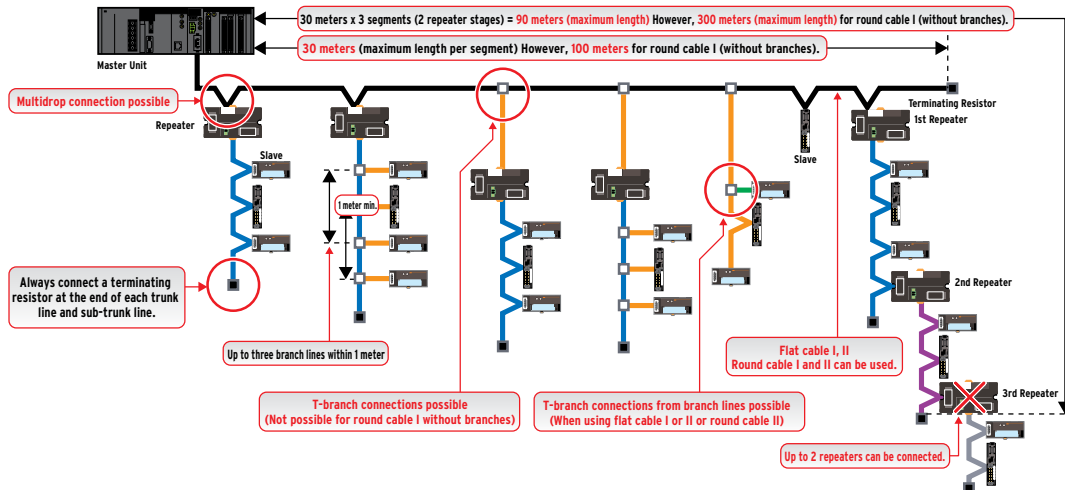

Example of wiring for 93.75 kbps (Application: Long-distance wiring and free wiring)

Example using round cable I

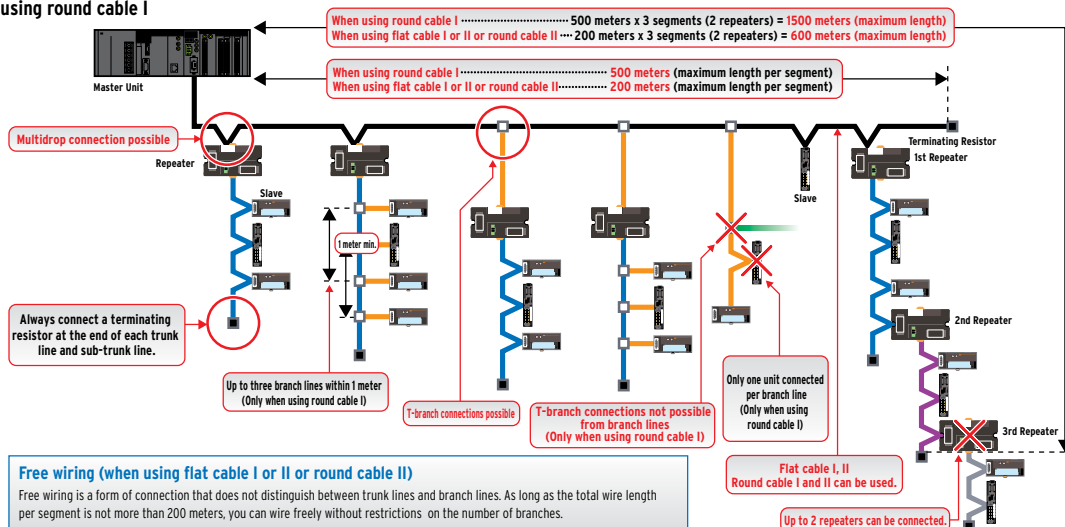

### Free wiring (when using flat cable I or II or round cable II)

Free wiring is a form of connection that does not distinguish between trunk lines and branch lines. As long as the total wire length per segment is not more than 200 meters, you can wire freely without restrictions on the number of branches.

## Configuration Examples and Peripheral Devices

### Example with round cable I (2-wire)

Required peripheral equipment

Specification	Model	Number of units	Remarks
Open connector (for unit connection)	DCN4-TB4*	4	—
Terminating resistor	DRS1-T	1	—
Round cable I (2-wire)	—	1	Commercially available
Communications power supply	—	1	24 VDC
I/O power supply	—	1	24 VDC

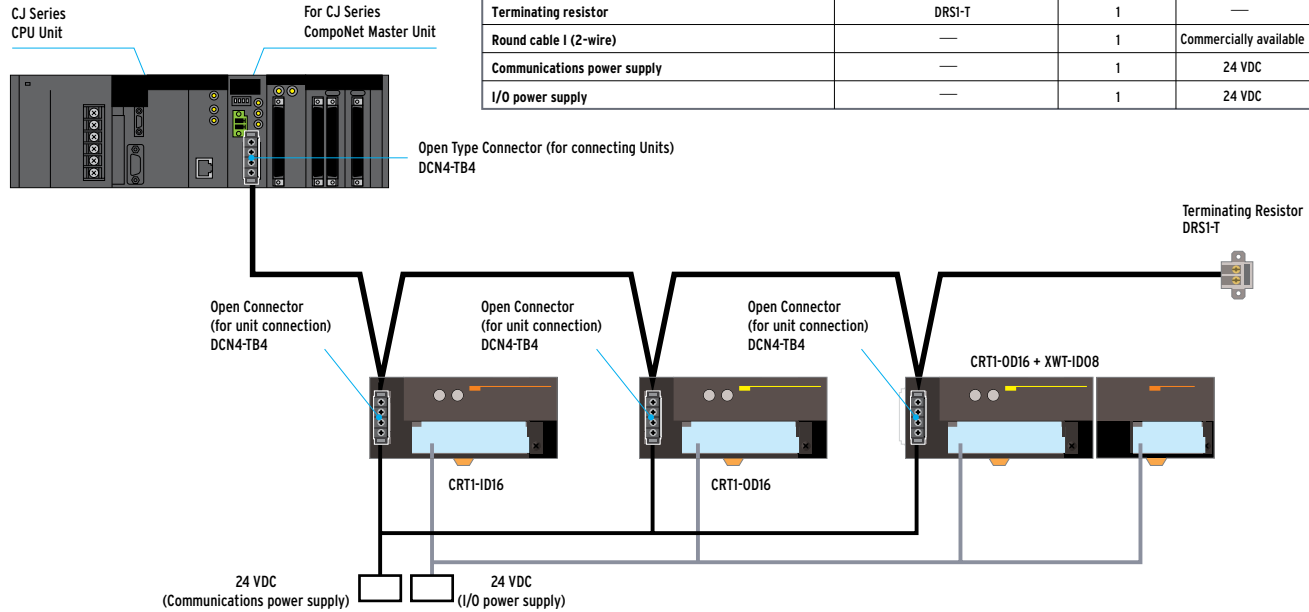

### Example with round cable II (4-wire)

Required peripheral equipment

Specification	Model	Number of units	Remarks
Open connector (for unit connection)	DCN4-TB4 *	4	—
Flat connector socket	DCN4-TR4 *	1	For terminating resistor connection
Terminating resistor	DCN4-TM4*	1	—
Round cable (4-wire)	—	1	Commercially available
Special tool	DWT-A01	1	—
Communications power supply	—	1	24 VDC
I/O power supply	—	1	24 VDC

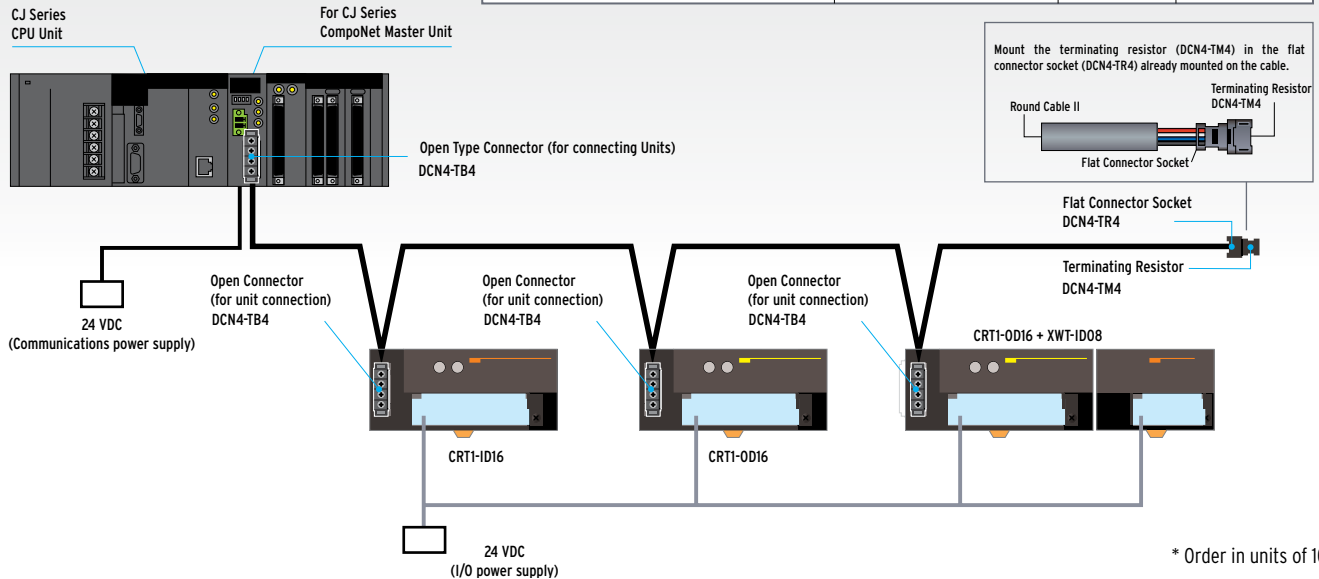

\* Order in units of 10.



## Application Examples

### CompoNet Applications for Every Type of Manufacturing Site

These applications offer high-performance communication and superior installability that aid in reducing takt times and cutting down the work of start-up and maintenance. Customers use CompoNet in a wide variety of applications.

#### Transfer lines

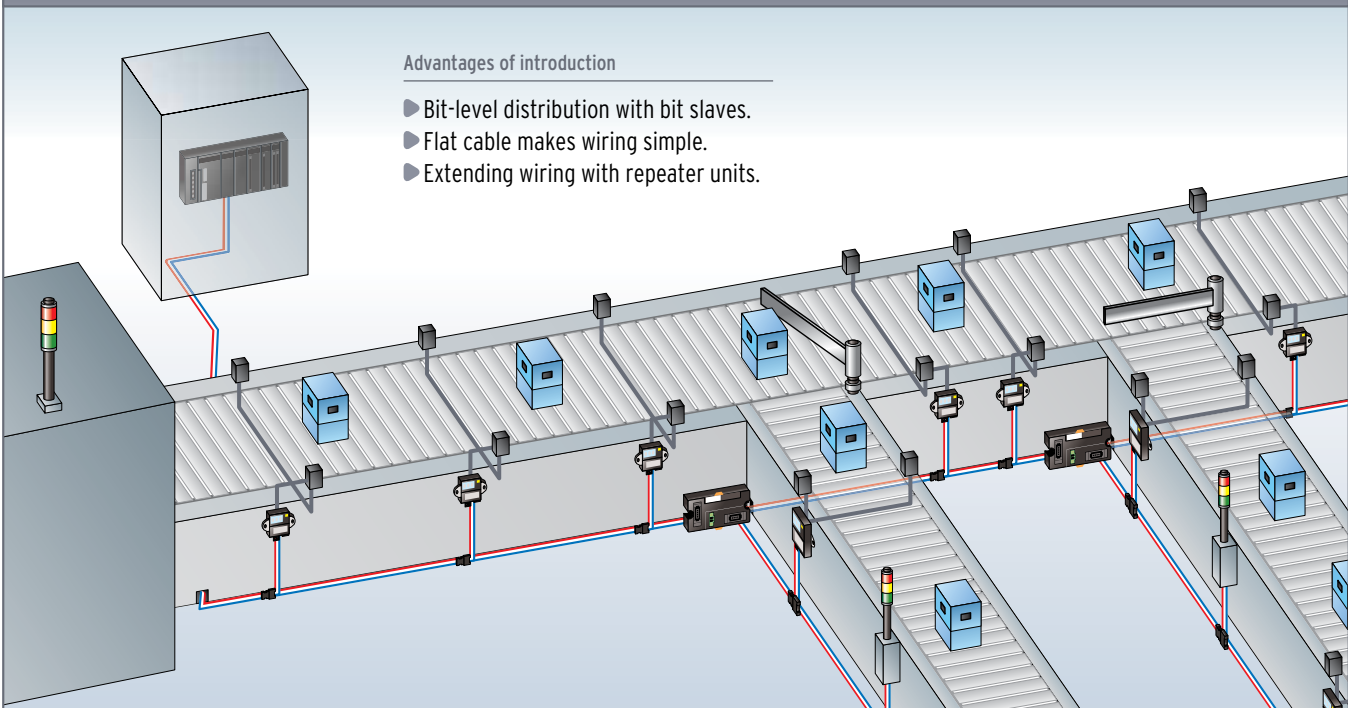

#### Electronic parts manufacturing device

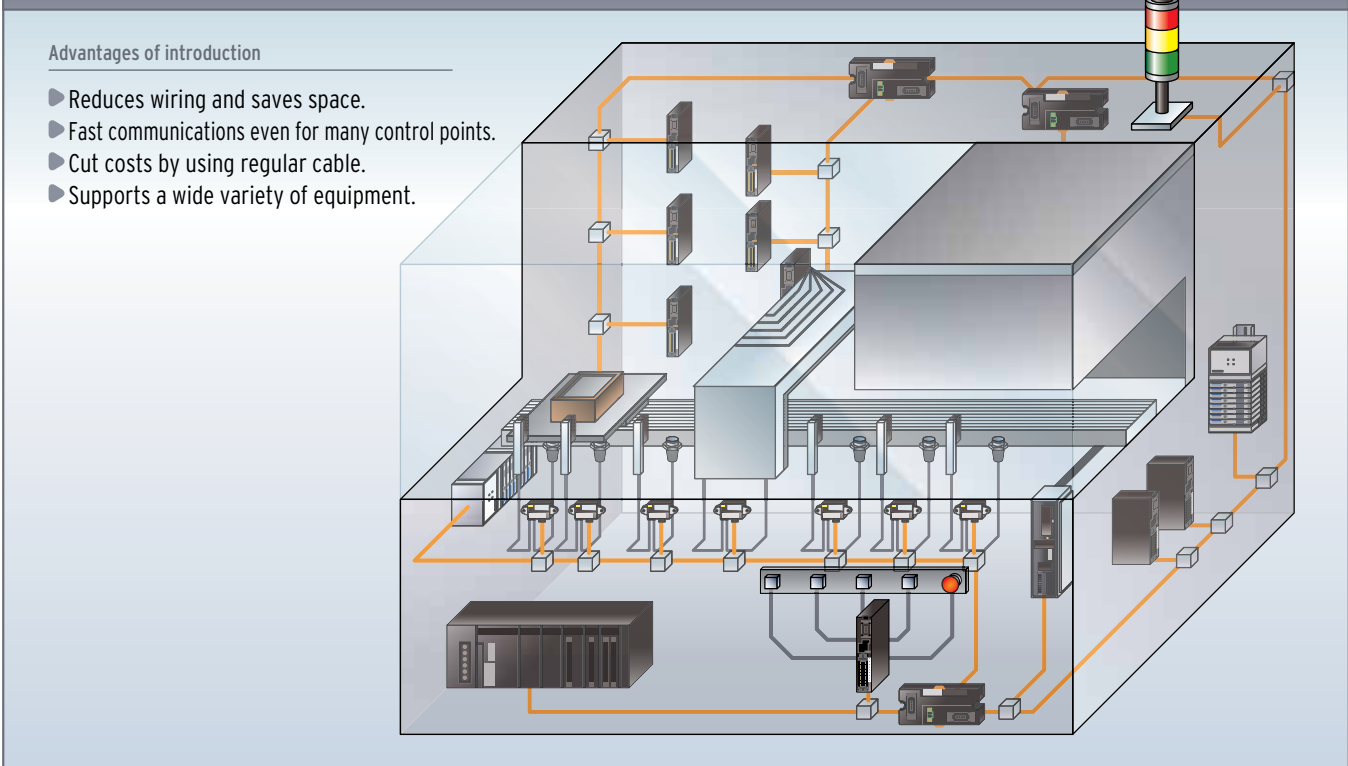

# Application Examples



## Building automation

### Advantages of introduction

- ▶ Wiring up to 1500 meters.
- ▶ Regular cables can be used.
- ▶ Plenty of connection capacity even for distributed installation.
- ▶ High resistance to noise.

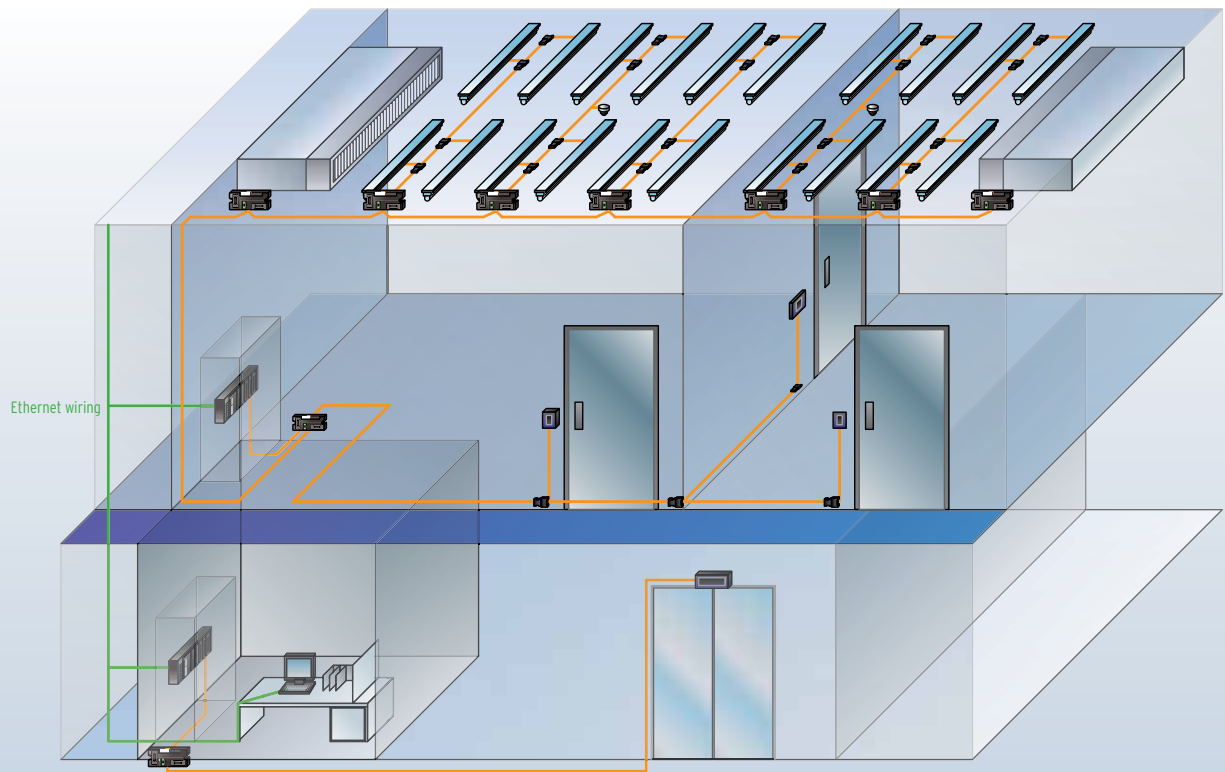

# Manufacturing Site Moving into the Global Open Network Era

Information layer  
Controller layer



Device layer



Sensor & Actuator layer



# CompoNet

The drastic changes to the environment faced by today's manufacturing industry has led a wide range of issues such as the standardization of system infrastructure and the shift to more advanced functions. In order to solve these issues, it is necessary to share on-site data, such as for product quality and how to respond to changes in the environment, to vertically start up devices utilizing this data and execute preventive maintenance universally and quickly. That is why attention is focusing on utilizing globally standardized "open networks" in the plant management layer, the control layer, and the device layer.

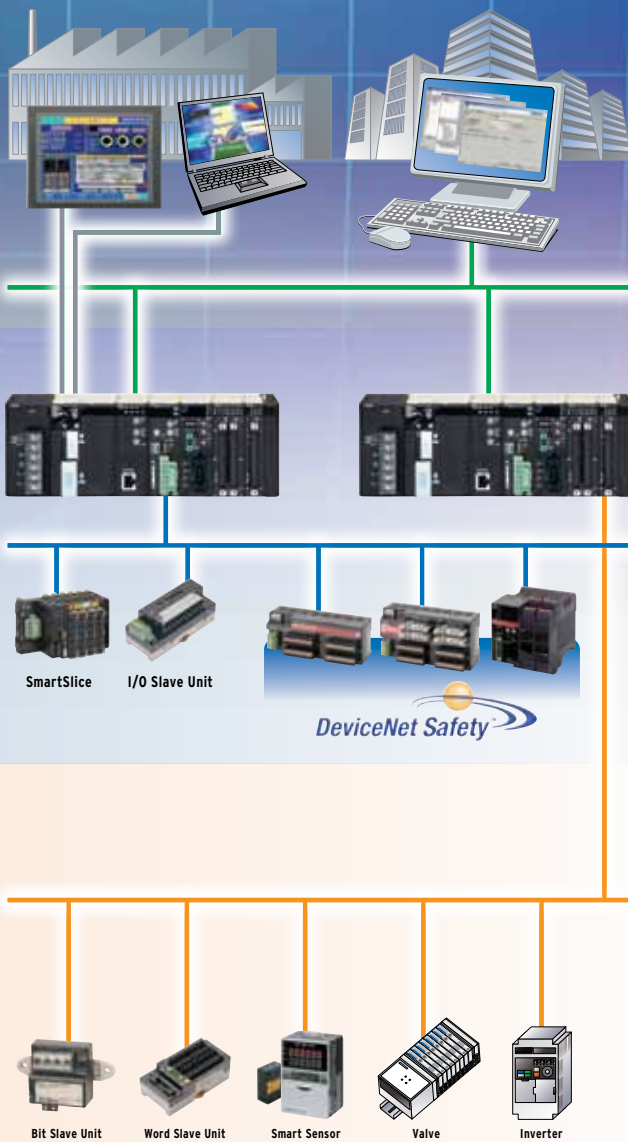

## "CompoNet" globally standardized open network in the sensor & actuator layer ——「CompoNet」——

CompoNet is the latest sensor & actuator layer open network. It was introduced and its specifications given by ODVA \*1 in 2006.

This open network fuses CIP network technology \*2 and high-level communications technology that consolidates the know-how for reducing the amount of wiring developed over many years at actual manufacturing sites.

CompoNet attains the industry's fastest class of communications, 1000 signals per ms between connected devices and the controller and provides a high-performance network environment never seen before.

The open network means reduced device costs, improved functions, the quality of procurement on a global level, and standardization turns design know-how into assets.

With the rapid expansion of family devices by many control equipment makers in Japan and overseas, CompoNet is establishing a multi-vendor environment that is a truly global open network.

\*1 The abbreviation for Open DeviceNet Vendor Association, a non-profit organization in the United States. ODVA supports networks based on CIP technology and is run by the main vendors inside and outside Japan. It has active bases in America, Europe, China, South Korea, and Japan.

\*2 CIP is the abbreviation for Common Industrial Protocol. This is a protocol that enables communications between open networks of equipment from multiple vendors. Control of each piece of equipment, programming, data collection, etc. can be standardized free of any restrictions due to the network type of differences among equipment.

Note: CompoNet, DeviceNet, and EtherNet/IP are registered trademarks of ODVA. ODVA Website:<http://www.odva.org/>

## Product Introductions

Master Units

### Master Units



■ CJ Series  
CJIW-CRM21



■ CS Series

Word Slaves

### Digital I/O Slaves

#### Two-tire Screw Terminal Block



■ Input Unit  
CRTI-ID08 (-1)  
CRTI-ID16 (-1)  
■ Output Unit  
CRTI-OD08 (-1)  
CRTI-OD16 (-1)  
■ Input/Output Unit  
CRTI-MD16 (-1)

#### Screw-Type Terminal Block, Relay Output/SSR Output



■ Relay Outputs  
CRTI-ROS08  
CRTI-ROS16  
■ SSR Outputs  
CRTI-ROF08  
CRTI-ROF16

#### Three-tire Screw Terminal Block



■ Input Units  
CRTI-ID08TA (-1)  
CRTI-ID08TAH (-1)  
CRTI-ID16TA (-1)  
CRTI-ID16TAH (-1)  
■ Output Units  
CRTI-OD08TA (-1)  
CRTI-OD08TAH (-1)  
CRTI-OD16TA (-1)  
CRTI-OD16TAH (-1)

■ I/O Unit  
CRTI-MD16TA (-1)  
CRTI-MD16TAH (-1)

#### Horizontal Slaves with e-CON Connectors



■ Input Units  
CRTI-ID16S (-1)  
CRTI-ID16SH (-1)  
CRTI-ID32S (-1)  
CRTI-ID32SH (-1)  
■ Output Units  
CRTI-OD16S (-1)  
CRTI-OD16SH (-1)  
CRTI-OD32S (-1)  
CRTI-OD32SH (-1)

■ I/O Unit  
CRTI-MD16S (-1)  
CRTI-MD16SH (-1)  
CRTI-MD32S (-1)  
CRTI-MD32SH (-1)

#### Vertical Slaves with e-CON Connectors



CRTI-VID08S (-1)  
CRTI-VOD08S (-1)

#### Vertical Slaves with MIL Connectors



CRTI-VID16ML (-1)  
CRTI-VOD16ML (-1)



CRTI-VID32ML (-1)  
CRTI-VOD32ML (-1)  
CRTI-VMD32ML (-1)

#### Horizontal Slaves with Clamp Terminals

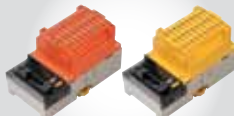

CRTI-ID08SL (-1)  
CRTI-OD08SL (-1)

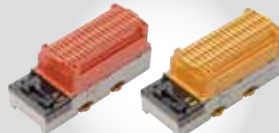













CRTI-ID16SL (-1)  
CRTI-OD16SL (-1)

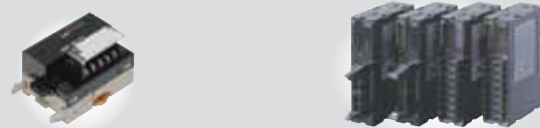

CRTI-MD16SL (-1)



# Product Introductions

Word Slaves		<b>Analog I/O Slaves</b>		
		<b>Screw Terminal Block</b>	<b>Vertical Slaves with e-CON Connectors</b>	<b>Vertical Slaves with MIL Connectors</b>
		 <ul style="list-style-type: none"> <li>■ Analog Input Unit CRTI-AD04</li> <li>■ Analog Output Unit CRTI-DA02</li> </ul>	 <p>CRTI-VAD04S CRTI-VDA02S</p> <p>Numerical Indicator Type CRTI-VAD02SD CRTI-VDA02SD</p>	 <p>CRTI-VAD04ML CRTI-VDA02ML</p> <p>Numerical Indicator Type CRTI-VAD02MLD CRTI-VDA02MLD</p>
		<b>Temperature Input Slaves</b>	<b>Expansion Units</b>	
		 <ul style="list-style-type: none"> <li>■ Input Units CRTI-TS04T CRTI-TS04P</li> </ul>	 <ul style="list-style-type: none"> <li>■ Input Units XWT-ID08 (-1) XWT-ID16 (-1)</li> <li>■ Output Units XWT-OD08 (-1) XWT-OD16 (-1)</li> <li>■ Input/Output Units XWT-VD08S (-1) XWT-VOD16ML (-1) XWT-VMD08S (-1) XWT-VMD16ML (-1)</li> </ul>	
<b>SmartSlice GRT1 Series</b>				
		<b>CompoNet Communications Unit</b>	<b>SmartSlice I/O Units</b>	
		 <p>GRT1-CRT</p>	 <ul style="list-style-type: none"> <li>GRT1-ID4 (-1)</li> <li>GRT1-OD4 (-1)</li> <li>GRT1-ID8 (-1)</li> <li>GRT1-OD8 (-1)</li> <li>GRT1-008 (-1)</li> <li>GRT1-ROS2</li> <li>GRT1-AD2</li> <li>GRT1-DA2C</li> <li>GRT1-DA2V</li> <li>GRT1-TS2P</li> <li>GRT1-TS2PK</li> <li>GRT1-TS2T</li> <li>GRT1-CT1 (-1)</li> </ul>	
Bit Slaves		<b>e-CON Connector Type</b>		<b>Clamp Type</b>
		<b>e-CON Connector Type</b>		<b>Clamp Type</b>
		 <ul style="list-style-type: none"> <li>■ Input Unit (IP20 compliant) CRT1B-ID02S (-1)</li> <li>■ Output Unit (IP20 compliant) CRT1B-OD02S (-1)</li> </ul>	 <ul style="list-style-type: none"> <li>■ Input Unit (IP54 compliant) CRT1B-ID02SP (-1) CRT1B-ID04SP (-1)</li> <li>■ Output Unit (IP54 compliant) CRT1B-OD02SP (-1)</li> </ul>	 <ul style="list-style-type: none"> <li>■ Input/Output Unit (IP54 compliant) CRT1B-MD04SLP (-1)</li> </ul>
Repeater Unit		<b>Sensor Communications Unit</b>		
		<b>Repeater Unit</b>		<b>Sensor Communications Unit</b>
		 <p>CRS1-RPT01</p>	 <p>ZS-CRT</p>	

## Product Introductions

The CompoNet network lets you connect to units and branch and extend cables by just mounting connectors on communications cables and units. The cable connection and branching methods depend on the cable type and branching form.

Four types of cable can be used on CompoNet networks.

- Round cable I (2-wire), commercially available
- Round cable II (4-wire), commercially available
- Flat cable I (without sheath) DCA4-4F10
- Flat cable II (with sheath) DCA5-4F10

The terminating resistors, connectors, and special tools depend on the cable type.

Peripheral equipment

Cable type	Unit connection and branching connector	Terminating resistor	Tool
<b>Round Cable I (2-wire)</b>  Commercially available	<ul style="list-style-type: none"> <li>Open Type Connector (For connecting Units) DCN4-TB4</li> </ul> 	<ul style="list-style-type: none"> <li>Terminating Resistor DRS1-T</li> </ul> 	
<b>Round Cable II (4-wire)</b>  Commercially available	<ul style="list-style-type: none"> <li>Open Connector (For connecting Units) DCN4-TB4</li> </ul> 	<ul style="list-style-type: none"> <li>Terminating Resistor DCN4-TM4</li> <li>Flat Connector Socket DCN4-TR4</li> </ul>   <p>Mount the terminating resistor (DCN4-TM4) in the flat connector socket (DCN4-TR4) already mounted on the cable.</p> 	<ul style="list-style-type: none"> <li>Special Tool For flat cable I (without sheath) DWT-A01</li> </ul> 
<b>Flat Cable I (without sheath)</b>  DCA4-4F10	<ul style="list-style-type: none"> <li>Flat Connector Socket DCN4-TR4</li> <li>Flat Connector Plug DCN4-BR4</li> <li>Multidrop Connector DCN4-MD4</li> </ul>   	<ul style="list-style-type: none"> <li>Terminating Resistor DCN4-TM4</li> </ul> 	<ul style="list-style-type: none"> <li>Special Tool For flat cable I (without sheath) DWT-A01</li> </ul> 
<b>Flat Cable II (with sheath)</b>  DCA5-4F10	<ul style="list-style-type: none"> <li>Flat Connector Socket DCN5-TR4</li> <li>Flat Connector Plug DCN5-BR4</li> </ul>  	<ul style="list-style-type: none"> <li>Terminating Resistor DCN5-TM4</li> </ul> 	<ul style="list-style-type: none"> <li>Special Tool For flat cable II (with sheath) DWT-A02</li> </ul> 



## Reference Data



	<b>AS-I V2.1</b>	<b>CC-Link/LT</b>	<b>CompoNet</b>
<b>Cyclic Time</b>	10ms/434 points	2.0ms/1024 points at 2.5Mbps	1.0ms/1024 points at 4Mbps
<b>IO Numbers</b>	434 (248/186) (v2.1)	2048 (1024/1024)	2560 (1280/1280)
<b>Length</b>	Total: 100m	Trunk: 35m at 2M	Trunk: 500m at 93.75K Trunk: 100m at 1.5M Trunk: 30m at 4M, 3M Triple the trunk line w/ repeater
<b>IO Message</b>	Polling	Broadcast polling + Interval Timed Response	Multicast poling
<b>Message Communication</b>	Not Supported	Not Supported	Supported
<b>Noise Immunity</b>	IEC61000	IEC61000	IEC610000
<b>Communication Units</b>	62 nodes	64 nodes	384 node Word type 128 nodes Bit type 256 nodes
<b>Cable</b>	Special 2 pair cables	» Special 4 pair Flat cables » Round cable (VCTF)	» Special 4 pair Flat cables » Round cable (VCTF, Belden)

## Family

Master	<p><b>YASKAWA ELECTRIC CORPORATION</b></p> <p>+81-4-2962-5823 www.e-mechatronics.com</p>  <p><b>265IF-01(CompoNet Master Communication Module)</b> [JAPMC-CM2390-E]</p> <p><b>► Features</b></p> <ol style="list-style-type: none"> <li>265IF-01 can be connected to the abundant slave group as a CompoNet master.</li> <li>265IF-01 is attached to the optional slot of the MP2000 series controller.</li> </ol>
	<p><b>SMC CORPORATION</b></p> <p>+81-3-5207-8249 www.smcworld.com</p> <p>Overseas sales areas: Europe, North America, Asia-Pacific, China</p>  <p><b>Fieldbus System Compatible with CompoNet™</b> [EX120/I21/I22 Series]</p> <p><b>► Features</b></p> <ol style="list-style-type: none"> <li>Output type : Compatible with NPN(+COM.)/PNP(-COM.)</li> <li>Applicable Solenoid Valve Series : SY/SVXVO Series</li> <li>Low Power Consumption : SY Series also available with a power saving 0.1W circuit.</li> </ol>
Solenoid Valves	<p><b>CKD CORPORATION</b></p> <p>Europe TEL : +81-(0)568-74-1303 North America TEL : +81-(0)568-74-1303 Asia-Pacific TEL : +81-(0)568-74-1303 China TEL : +81-(0)568-74-1303 www.ckd.co.jp/english</p> <p>Overseas sales areas: Europe, North America, Asia-Pacific, China, Other</p>  <p><b>Pilot type 3-5 ports pilot valve</b> [46 series]</p> <p><b>► Features</b></p> <ol style="list-style-type: none"> <li>Very long life: more than 60 million times due to elastic seal with few air leakage.</li> <li>Enhanced safety function: Manual override button with protective cover and integrated check valve preventing back pressure.</li> </ol>
	<p><b>Koganei Corporation</b></p> <p>+81-42-383-7271 www.koganei.co.jp</p> <p>Overseas sales areas: Europe, North America, Asia-Pacific</p>  <p><b>CompoNet-compatible Solenoid Valves</b> [JA Series]</p> <p><b>► Features</b></p> <ol style="list-style-type: none"> <li>Thin and Compact: Valve width of only 10 mm with effective area of 3.5 mm<sup>2</sup>.</li> <li>Lower power consumption. Standard: 0.5 W Low current type: 0.25 W</li> <li>Two 3-port valves in one body.</li> </ol>  <p><b>CompoNet-compatible Solenoid Valves</b> [F Series]</p> <p><b>► Features</b></p> <ol style="list-style-type: none"> <li>Single/double dual-use valves.</li> <li>Three of valve widths: 10, 15 and 18 mm</li> <li>Uses dual-use fittings for different tube sizes.</li> </ol>
	<p><b>IAI Corporation</b></p> <p>www.intelligentactuator.com/ Overseas sales areas: Europe, North America, Asia-Pacific, China</p>  <p><b>ROBO CYLINDER</b></p>  <p><b>Controller</b> [ACON-C PCON-C]</p> <p><b>Controller for RCA/RCA2 Series ROBO CYLINDER</b> [ACON-C/CG]</p> <p><b>► Features</b></p> <ol style="list-style-type: none"> <li>Designed for 24 VDC servomotors.</li> <li>Multipoint positioning: up to 512 points.</li> <li>High speed: Up to 800 mm/s.</li> </ol>  <p><b>Controller for RCP2/RCP3 Series ROBO CYLINDER</b> [PCON-C/CG]</p> <p><b>► Features</b></p> <ol style="list-style-type: none"> <li>Designed for 24 VDC pulse motors.</li> <li>Multipoint positioning: up to 512 points.</li> <li>High power in lower speed range.</li> </ol>
<p><b>PATLITE Corporation</b></p> <p>+81-6-6763-8220 www.patlite.com</p> <p>Overseas sales areas: Europe, North America, Asia-Pacific, China</p>  <p><b>CompoNet Supported Signal Tower</b> [LE-K3(B)/W-RYG]</p> <p><b>► Features</b></p> <ol style="list-style-type: none"> <li>Use of ultra-bright LED enhanced for illumination.</li> <li>Two selectable sound patterns with adjustable volume.</li> </ol>  <p><b>CompoNet Supported Wall-Mount Signal Tower</b> [WEP-K3(B)-RYG]</p> <p><b>► Features</b></p> <ol style="list-style-type: none"> <li>A 37.5 mm-thin design that significantly enhances integration with equipment as a built-in signal system.</li> <li>Clear vertical cut lens enhanced for illumination over a wide perspective.</li> <li>Built-in audible alarm.</li> </ol>	
Gateway	<p><b>JSK CO., LTD.</b></p> <p>+81-72-661-4071 www.nihon-seigyo.co.jp</p>  <p><b>CompoNet-RS422/485 Converter</b> [OWPC-001]</p> <p><b>► Features</b></p> <ol style="list-style-type: none"> <li>Connects conventional RS422/485 control devices to CompoNet.</li> <li>Programmable RS422/485 interface realizes easy software implementation.</li> <li>DeviceNet, CC-Link, other protocols are coming soon.</li> </ol>
	<p><b>AIOI SYSTEMS CO.,LTD.</b></p> <p>+81-3-3764-0228 www.hello-aioi.com/en info@hello-aioi.com</p> <p>Overseas sales areas: Europe, North America, Asia-Pacific, China Other</p>  <p><b>Gateway Controller for CompoNet</b> [TW218]</p> <p><b>► Features</b></p> <ol style="list-style-type: none"> <li>AI-NET-CompoNet Gateway Controller.</li> <li>Maximum coDrop Light Modules Number is 64.</li> </ol>

# Family

Connector	<p><b>Honda-connectors</b></p> <p>+81-6-6376-4717  <a href="http://www.honda-connectors.co.jp">www.honda-connectors.co.jp</a></p> <p>Overseas sales areas:          Europe, North America, China,          Asia-Pacific, Southeast Asia</p>		<p><b>Connector</b>  <b>[HCN- (S)4( ) (FDG +)]</b>  <b>[HCN-TB 4LMZG +]</b></p>	<p>► <b>Features</b></p> <p>1. PCB SIDE          • Smaller than conventional product          • Mating area of SLIM TYPE is 8mm, compared with 10mm of conventional product.</p> <p>2. CABLE SIDE          • INSIDE HOOK(LOCK SYSTEM INSIDE CASE)          • Possible to lead cables to 2 directions out.</p>
	<p><b>Tayco Electronics AMP K.K</b></p> <p>+81-44-844-8080  <a href="http://www.tycoelectronics.com">www.tycoelectronics.com</a></p>		<p><b>RITS Connector (e-CON)</b>  <b>[X-1473562-4]</b></p>	<p>► <b>Features</b></p> <p>1. New Chisel Press Contacts for sensor cables.          2. No special crimping tool required for easy termination.          3. Two contact points for good connection and more security.</p>
	<p><b>3M Company</b></p> <p><a href="http://www.3M.com/interconnects">www.3M.com/interconnects</a></p>		<p><b>Mini-Clamp Connector:</b>  <b>[3710x-xxx-000 FL]</b></p>	<p>► <b>Features</b></p> <p>1. IDC technology reduces process/cost of wire termination.          2. Crimped using standard pliers to reduce tool costs.          3. Design offers multiple gauges and wire size diameters.</p>

## SWCC SHOWA CABLE SYSTEMS CO., LTD.

+81-3-3597-7117  
www.swcc.co.jp

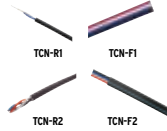

### CompoNet Cable

#### Features

- TCN-R1 Round Cable 19AWGx2C (CL3,CM,cUL-CM,75°C)
- TCN-R2 Round Cable 19AWGx4C (CL3,CM,cUL-CM,75°C)
- TCN-F1 Flat Cable 21AWGx2C+19AWGx2C
- TCN-F2 Flat Cable 21AWGx2C+19AWGx2C

## KURAMO ELECTRIC CO., LTD.

+81-778-22-1500  
www.kuramo.co.jp



### CompoNet Flat Cable I, II CompoNet Round Cable I, II

- ① CompoNet Flat Cable KOMP-F I 21AWG x 2, 19AWG x 2
- ② CompoNet Flat Cable KOMP-F II 21AWG x 2, 19AWG x 2
- ③ CompoNet Round Cable KOMP-R I 19AWG x 2
- ④ CompoNet Round Cable KOMP-R II 19AWG x 4

#### Features

1. CompoNet Flat Cable KOMP-F I  
Heat resistance : 90 Flame resistance : FT4  
UL certification : UL13 CL2 CSA certification : CSA C22.2 No.210
2. CompoNet Flat Cable KOMP-F II  
Oil resistance -Heat resistance : 90  
Flame resistance : UL FLAME EXPOSURE UL certification : UL13 PLTC,UL444 CMG  
CSA certification : CSA C22.2 No.214
3. CompoNet Round Cable KOMP-R I  
CompoNet Round Cable KOMP-R II  
Oil resistance Heat resistance : 90  
Flame resistance : FT4 UL certification : UL13 PLTC,UL444 CMG  
CSA certification : CSA C22.2 No.214

## NICHIGOH COMMUNICATION ELECTRIC WIRE CO., LTD

+81-72-923-5104  
www.nichigoh.co.jp



### UNICOMPO series

- CompoNet Flat type cable (Sheath less) : UNICOMPO FQ -T
- CompoNet Flat type cable (With Sheath) : UNICOMPO FQ -T
- CompoNet Round type cable (2c) : UNICOMPO RQ -T
- CompoNet Round type cable (4c) : UNICOMPO RQ -T

#### Features

1. Conformity to UL/cUL standard(CM,CL2)
2. Conformity to NFPA79,NFPA70(NEC)
3. The RC type acquires CE, and is acquiring the FC type

### CompoNet Flat Cable I and II

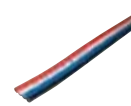

#### Daiko, E.W. [KCNF]

##### Features

1. Enables using unique isolation-displacement connectors for CompoNet.
2. Easy one-step IDC connection without insulation stripping.
3. UL AWM, CSA compliant.

#### Taiyo Electric Wire & Cable Co., Ltd. [KCNF-J]

##### Features

1. Enables using unique isolation-displacement connectors for CompoNet.
2. PVC jackets with polarity guide line for IP54 system.
3. Easy one-step IDC connection without insulation stripping.
4. UL AWM, CSA compliant

### Oil-resistant and Highly Flexible Round Cable II for CompoNet

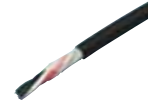

#### Hanshin Electric Wire & Cable Co., Ltd. [MRC-4]

##### Features

1. The cable can be used for mobile and oil-resistant wiring.
2. Round cable for low cost installation.
3. UL AWM, CSA compliant.

## Kanetsu Co., Ltd

+81-75-662-0996  
www.kanetuu.co.jp/  
info\_kanetsu@kanetuu.co.jp

Overseas sales areas:  
Europe, North America, China,  
Asia-Pacific, Taiwan, Vietnam

### CompoNet Round Cable I and II

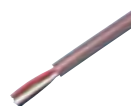

#### Onamba Co., Ltd [VCTF-2C, VCTF-4C]

##### Features

- Round cable for low cost installation.

#### Kawai Cable, Ltd. [VCTF-2C, VCTF-4C]

##### Features

- Round cable for low cost installation.



**OMRON Corporation**

[open\\_integration@omron.co.jp](mailto:open_integration@omron.co.jp)

**MPU for CompoNet Slave, MPU for CompoNet Master**

**► Features**

**Slave:** Omron offers the development approach of three types by the function of the slave.

1. Few-Point Slave
  - I/O Size: Digital I/O in MAX 32 points
  - Application interface: Via I/O port
2. Multi-Points Slave
  - I/O size: Outputs: 0 to 256 points (32 bytes)
  - Inputs: 0 to 256 points (32 bytes)
  - Application interface: DPRAM
3. Protocol stack
  - No restriction in MPU and OS

**Master:** Omron offers two kinds of development approaches.

1. DP-RAM/F MPU
  - Development is unnecessary of the communication protocol.
  - The communication protocol including RAS is mounted on MPU.
2. Library
  - System Call I/F of ITRON

**HMS INDUSTRIAL NETWORKS Co.,Ltd**

Europe  
Tel: +46-35-172900  
North America  
Tel: +1-312-829-0601  
China  
Tel: +86-10-8532-3183

Europe  
[info@hms.se](mailto:info@hms.se)  
USA  
[us-sales@hms-networks.com](mailto:us-sales@hms-networks.com)  
CHINA  
[cn-sales@hms-networks.com](mailto:cn-sales@hms-networks.com)

Overseas sales areas:  
Europe, North America, Asia-Pacific, China



**Anybus CompactCom Component [ABCC-CPN]**

**► Features**

1. Embedded CompoNet interface for device manufacturers
2. Common hardware & software interface between DeviceNet, ControlNet & EtherNet/IP
3. Available with or without plastic housing
4. Development time: 1-3 months, with fast ROI
5. Tested and verified for full network conformance

**Hilscher GmbH**

Europe  
Hilscher GmbH (Germany)  
Tel: +49-(0)-6190-9907-0  
North America  
Hilscher North America, Inc. (USA)  
Tel: +1-630-505-5301  
Asia-Pacific  
Hilscher GmbH (Germany)  
Tel: +49-(0)-6190-9907-0  
China  
Hilscher GmbH (Shanghai Rep. Office)  
Tel: +86-(0)-21-6355-5161  
India  
Tel: +91-(0)-11-4051-5640

[info@hilscher.com](mailto:info@hilscher.com)

Overseas sales areas:  
Europe, North America, Asia-Pacific, China, Other



**CompoNet Communication Controller [netX 50 / netX 100 / netX 500]**

**► Features**

1. CompoNet, DeviceNet, EtherNet/IP and various Fieldbus / Real Time Ethernet on one chip
2. Control by external CPU via DPM or Application can be implemented on the internal ARM (200MHz)
3. UART / USB / SPI / I2C / GPIO / LCD controller / ADC / PWM / DMA / CCD (depends on chip type)

**NSD Co., Ltd.**

+81-3-3342-1380  
 [www.nsd.co.jp/english/](http://www.nsd.co.jp/english/)  
 [ia-info@nsd.co.jp](mailto:ia-info@nsd.co.jp)

Overseas sales areas:  
North America

**CompoNet Master Stack Tool Kit (C-MTK) [CMK-100]**

**► Features**

1. A developers' tool kit to implement communication function for CompoNet master modules
2. CompoNet master protocol stack firmware example source codes and various kinds of technical items are included
3. Software development and its technical services can be provided, if a industrial device vendor would like to develop CompoNet devices.

Additional Literature available from [omron247.com](http://omron247.com)

W476 SmartSlice CompoNet GRT1-CRT Operation Manual

W456 CompoNet Master Units Operation Manual

W457 CompoNet Slave and Repeater Units Operation Manual

W484 CompoNet CRT1-VAD and CRT1-VDA Operation Manual

W455 SmartSlice I/O Module Operation Manual

P056 CompoNet Datasheet



# OMRON

**OMRON ELECTRONICS LLC • THE AMERICAS HEADQUARTERS**

Schaumburg, IL USA • 847.843.7900 • 800.556.6766 • [www.omron247.com](http://www.omron247.com)

**OMRON CANADA, INC. • HEAD OFFICE**

Toronto, ON, Canada • 416.286.6465 • 866.986.6766 • [www.omron247.com](http://www.omron247.com)

**OMRON ELETRÔNICA DO BRASIL LTDA • HEAD OFFICE**

São Paulo, SP, Brasil • 55.11.2101.6300 • [www.omron.com.br](http://www.omron.com.br)

**OMRON ELECTRONICS MEXICO SA DE CV • HEAD OFFICE**

Apodaca, N.L. • 52.811.156.99.10 • 001.800.556.6766 • [mela@omron.com](mailto:mela@omron.com)

**OMRON ARGENTINA • SALES OFFICE**

Cono Sur • 54.11.4783.5300

**OMRON CHILE • SALES OFFICE**

Santiago • 56.9.9917.3920

**OTHER OMRON LATIN AMERICA SALES**

54.11.4783.5300