

THIS DRAWING IS UNPUBLISHED. VERTRAULICHE UNVERÖFFENTLICHTE ZEICHNUNG. RELEASED FOR PUBLICATION. FREI FUER VERÖFFENTLICHUNG. 2000. MATED WITH: PASSEND ZU: 1355639. BY TYCO ELECTRONICS CORPORATION. ALL RIGHTS RESERVED. ALLE RECHTE VORBEHALTEN. COPYRIGHT 2000.

| LOC | DIST | REVISIONS | | | | | |
|-----------------------|------|-----------|-----|------------------------|-----------|-----|------|
| A | - | P | LTR | DESCRIPTION | DATE | DWN | APVD |
| PROJEKT NR.: 95-52384 | | A | | New Drawing | 31JAN100 | ASC | JWO |
| | | B | | Locking latch improved | 17APR2001 | ASC | JWO |
| | | BI | | Spec number added | 03NOV2003 | SBL | ASC |

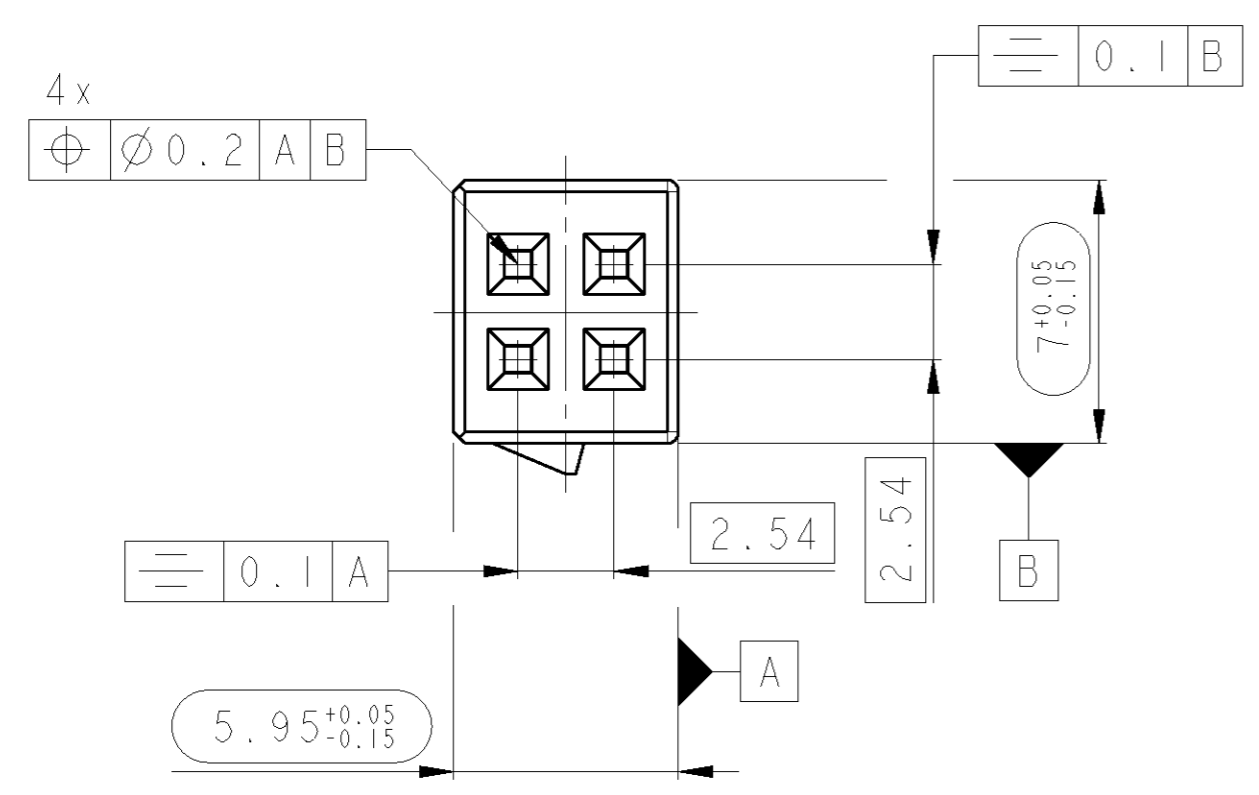

NOTES
Bemerkungen

1. ONLY THE GERMAN-LANGUAGE VERSION SHALL BE BINDING
Massgebend ist der deutsche Text
2. WIRE SIZE RANGE UNTIL 0,75mm²
Drahtgrössenbereich bis 0,75mm²
3. DETAILS OF DESIGN ARE LEFT TO MANUFACTURER
Einzelheiten der Ausführung bleiben dem Hersteller überlassen

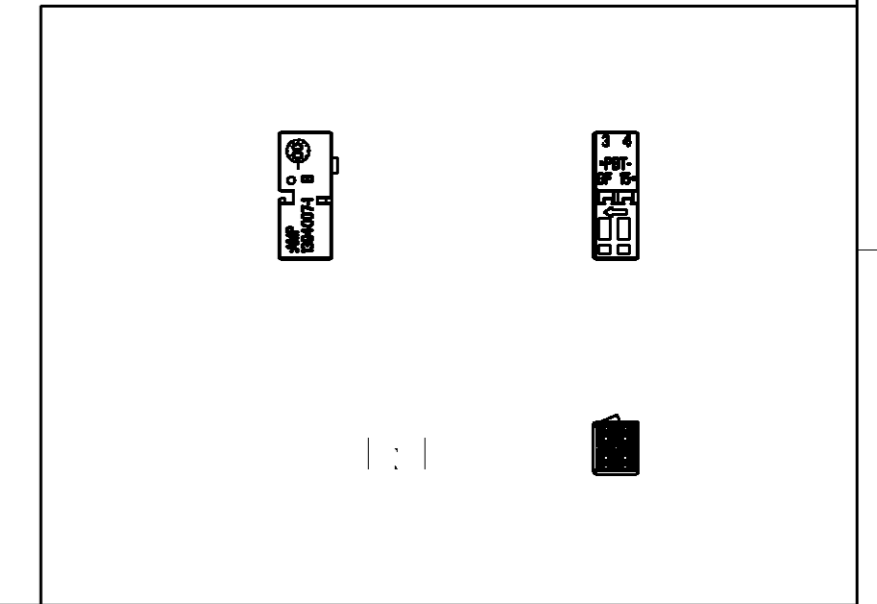
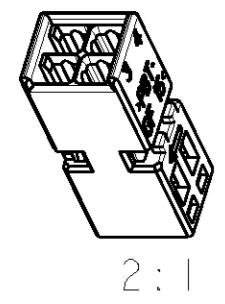
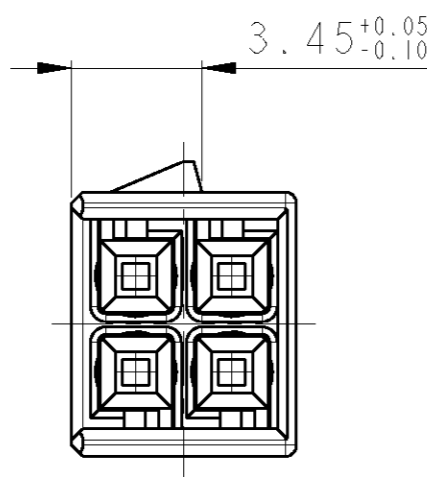
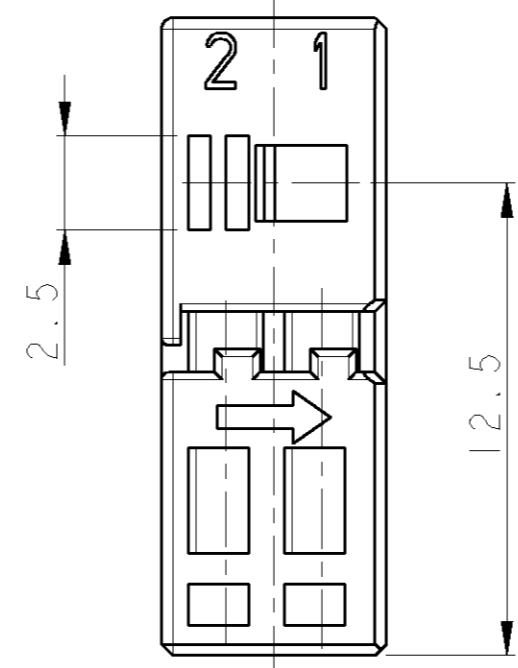
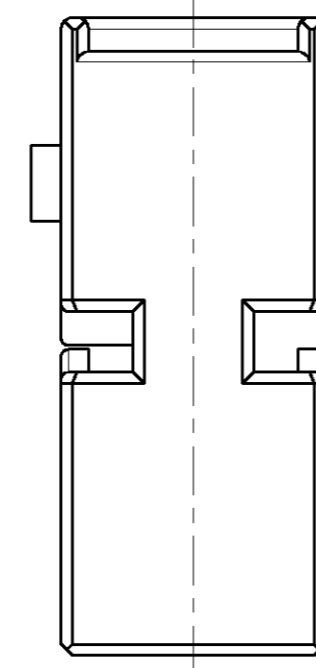
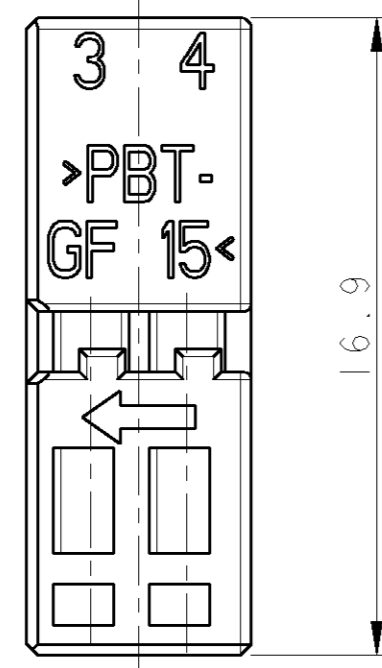
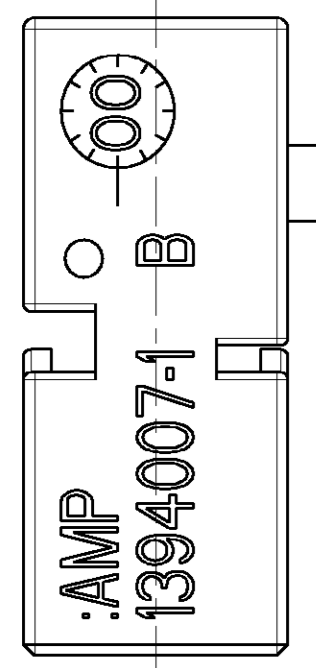

| AMP PART NO. | REV. | MATERIAL | SURFACE COLOR | DESCRIPTION | ITEM NO. |
|--------------|------|----------|---------------|----------------|----------|
| 1394007-1 | B | PBT-GF15 | schwarz/BLACK | SOCKET HOUSING | 1 |

| | | | |
|-------------------------------|---|--|----|
| DIMENSIONS: MASSEINHEITEN: mm | | TOLERANCES UNLESS OTHERWISE SPECIFIED: ALLGEMEINTOLERANZEN DIN 16901-140 | |
| 0 PLC | ± | 1 PLC | ± |
| 2 PLC | ± | 3 PLC | ± |
| 4 PLC | ± | ANGLES/WINKEL | ±° |
| FINISH/OBERFLAECHE/FARBE | | PBT-GF15 | |

| | | |
|------------------------------------|-------------|-----------|
| DWN | A. Schroebe | 10JAN2000 |
| CHK | J. Woller | 10JAN2000 |
| APVD | - | - |
| PRODUCT SPEC | 108-18214 | |
| APPLICATION SPEC | 114-18351 | |
| WEIGHT | 0.47g | |
| CUSTOMER DRAWING / KUNDENZEICHNUNG | | |

| | | | |
|---|---------|---------------------------|----------|
| | | tyco Electronics AMP GmbH | |
| | | D - 64625 Bensheim | |
| NAME: MOS Buchsengehäuse, 4polig MOS SOCKET HOUSING, 4POS. | | | |
| SIZE | A2 | CAGE CODE | 00779 |
| DRAWING NO. | 1394007 | RESTRICTED TO | NUR FUER |
| SCALE | 5:1 | SHEET | OF |
| MATERIAL | REV | DATE | BY |