

## DETAILS

<b>Product Number</b>	CA12392_LXP2-W
<b>Family</b>	Leila
<b>Type</b>	Assembly
<b>Color</b>	black
<b>Diameter</b>	21,6 mm
<b>Height</b>	14,7 mm
<b>Style</b>	round
<b>Optic Material</b>	PMMA
<b>Holder Material</b>	
<b>Fastening</b>	tape
<b>Status</b>	production ready
<b>ROHS Compliant</b>	Yes
<b>Date Updated</b>	10/04/2014



## OPTICAL PROPERTIES

LED	Viewing Angle	Light Beam	Efficiency	cd/lm	Connector
XP-E	48 deg	Wide	90 %	1.700	-
XP-G	43 deg	Wide	89 %	1.480	-
XT-E	41 deg	Wide	89 %	1.580	-
XP-G2	46 deg	Wide	87 %	1.500	-
XP-E2	43 deg	Wide	87 %	1.700	-
XP-L HI	44 deg	Wide	84 %	1.500	-
H35C0 (LEMWA33)	46 deg	Wide	87 %	1.480	-
H35B0 (LEMWA32)	45 deg	Wide	87 %	1.500	-
H35C1 (LEMWA33)	46 deg	Wide	90 %	1.500	-
LUXEON Q	42 deg	Wide	85 %	1.700	-
Z5	36 deg	Wide	93 %	1.700	-
Z5M1/Z5M2	47 deg	Wide	86 %	1.600	-
Z8Y22P	sim: 44	Wide	sim: 91 %	sim: 1.580	-

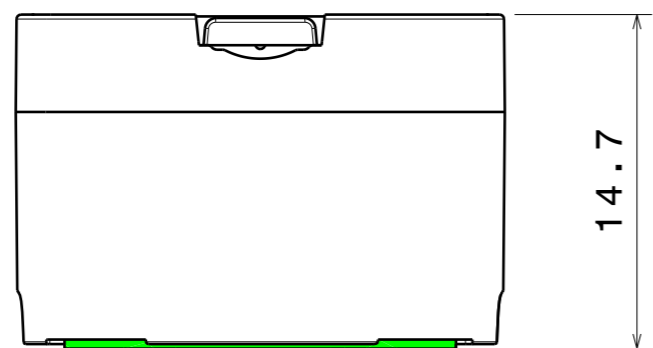

Front view  
Scale: 3:1

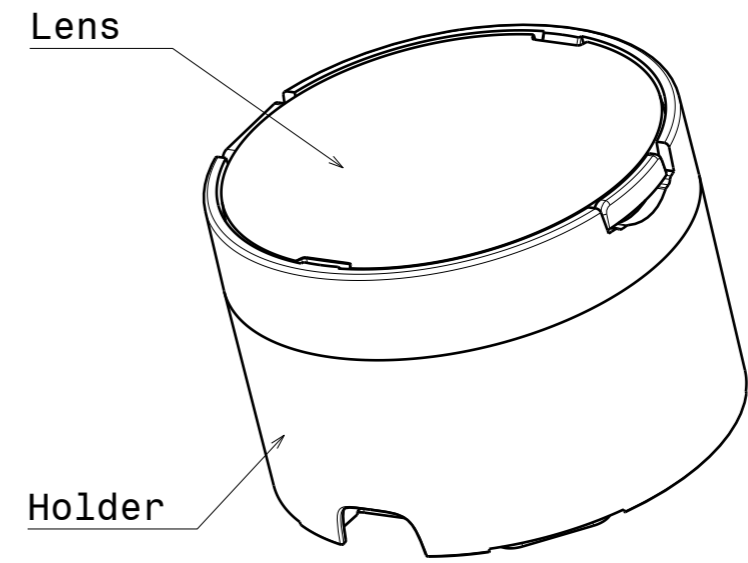

Isometric view  
Scale: 3:1

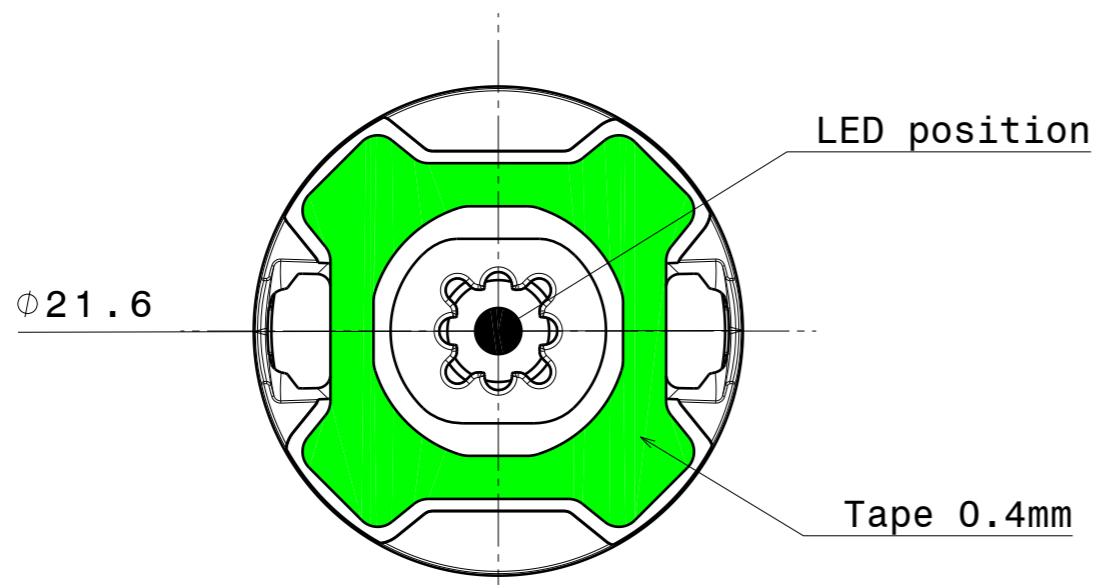

Bottom view  
Scale: 3:1

INDEX	DESCRIPTION	MATERIAL	COLOUR
1	Lens	PMMA	
2	Holder	PC	black
3	Tape	PU 2-sided foam tape	adhesive

Tolerances if not otherwise shown According to DIN ISO 2768-1 Linear measures: Up to 30mm class M, otherwise class C. According to DIN ISO 2768-2 Form and position: class L		<b>LEDiL</b> LediL Oy Salorankatu 10 FIN 24240 SALO Finland	
THIRD ANGLE PROJECTION:		DRAWING TITLE <b>Datasheet_LXP2-Series</b>	
This drawing is the property of LEDiL Oy. It may not be reproduced, copied or communicated without a written agreement with LEDiL Oy.		SIZE <b>A3</b>	PART NUMBER -
		SCALE 3:1	WEIGHT -
		SHEET 1/1	

Luminaire: Ledil Oy CA12392\_LXP2-W (Cree XP-E 77lm @ 250mA) Efficiency=90%  
Lamps: 1 x Cree XP-E 77lm @ 250mA

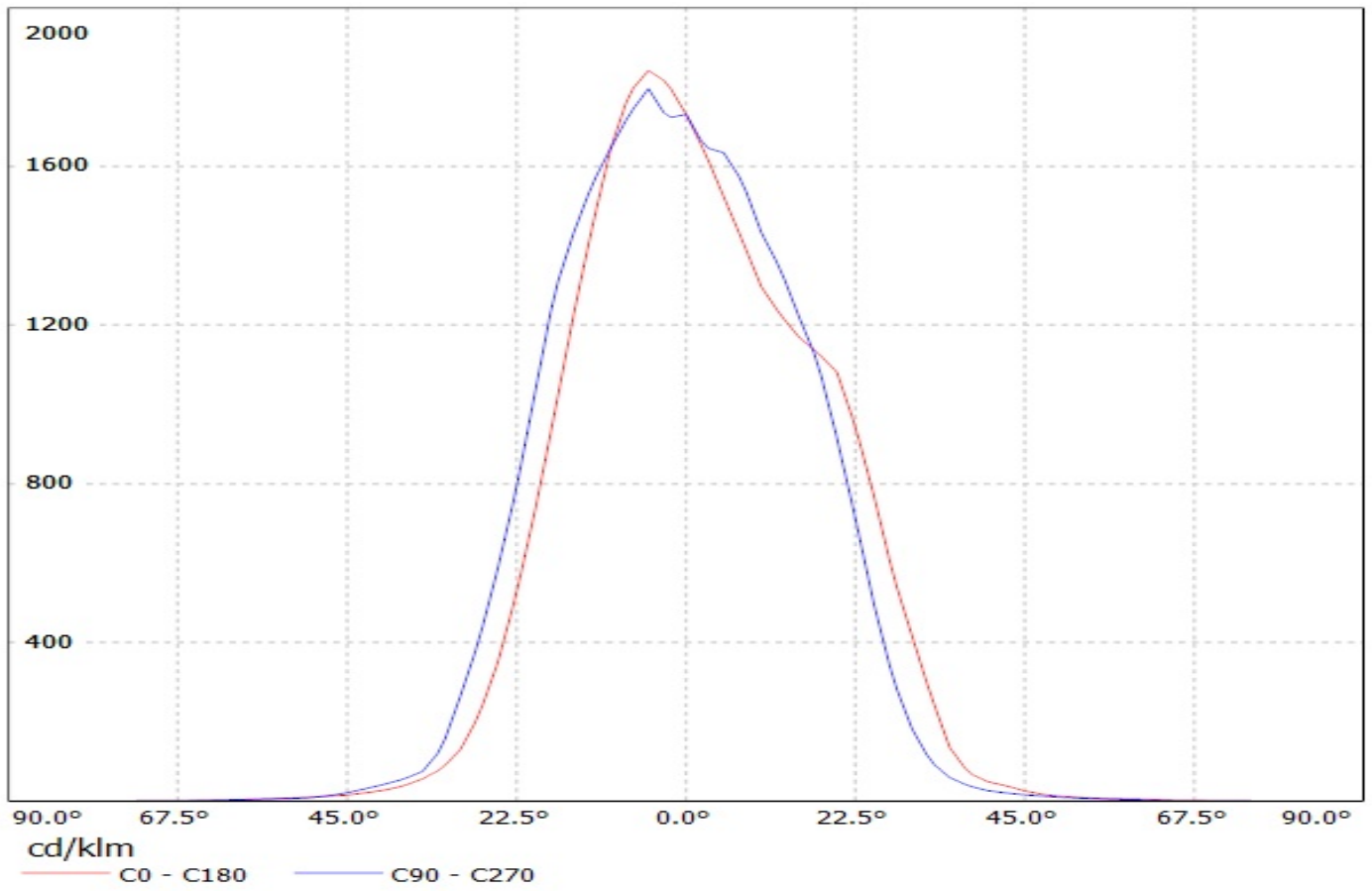

Luminaire: Ledil Oy CA12392\_LXP2-G-W (Cree XP-G 71lm @ 250mA) Efficiency=89%  
Lamps: 1 x Cree XP-G 89lm @ 250mA

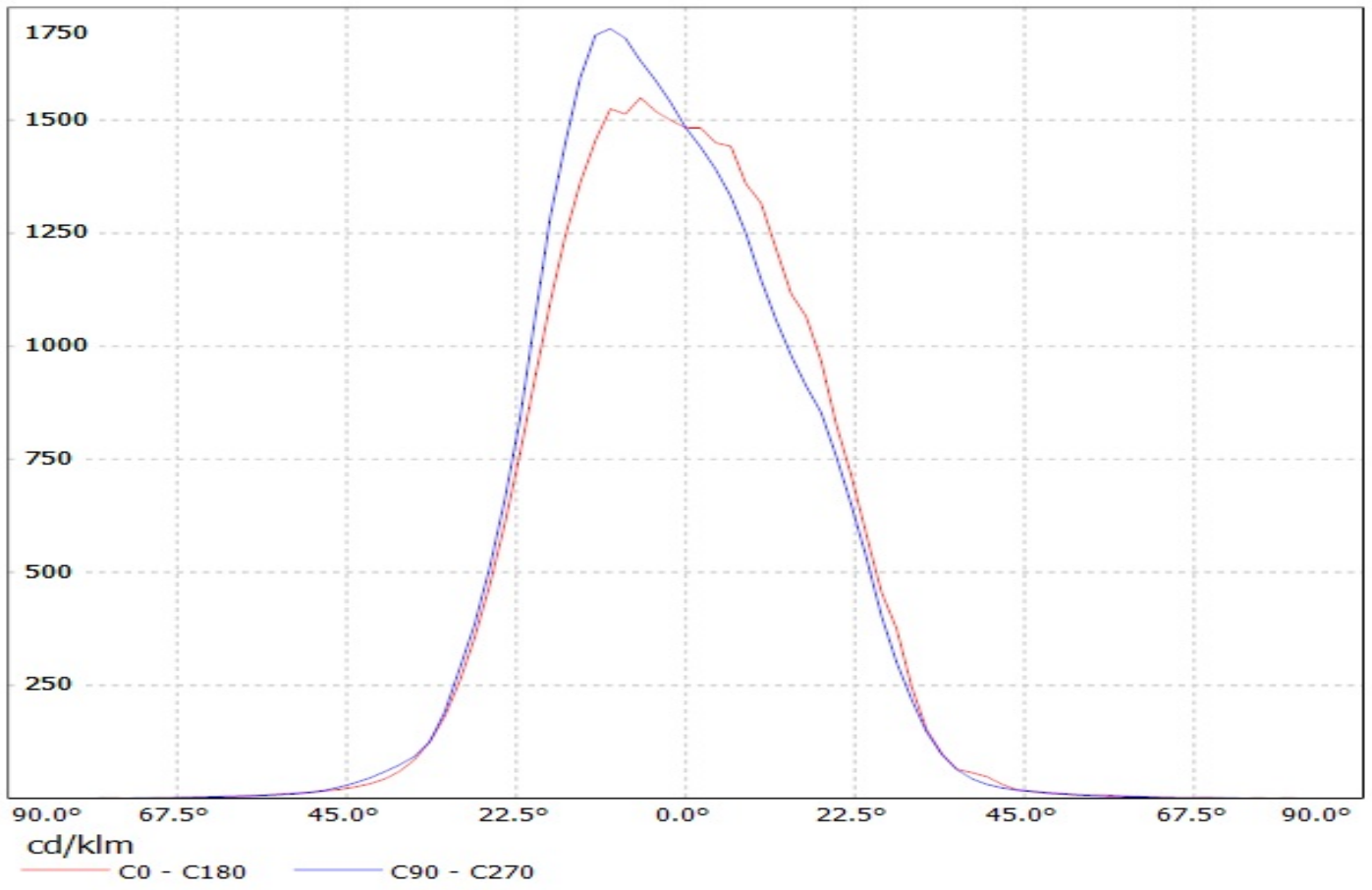

Luminaire: Ledil Oy CA12392\_LXP2-W-XT-E (CA12392\_LXP2-W-XT-E (AWT))  
Lamps: 1 x XT-E 113lm @ 250mA

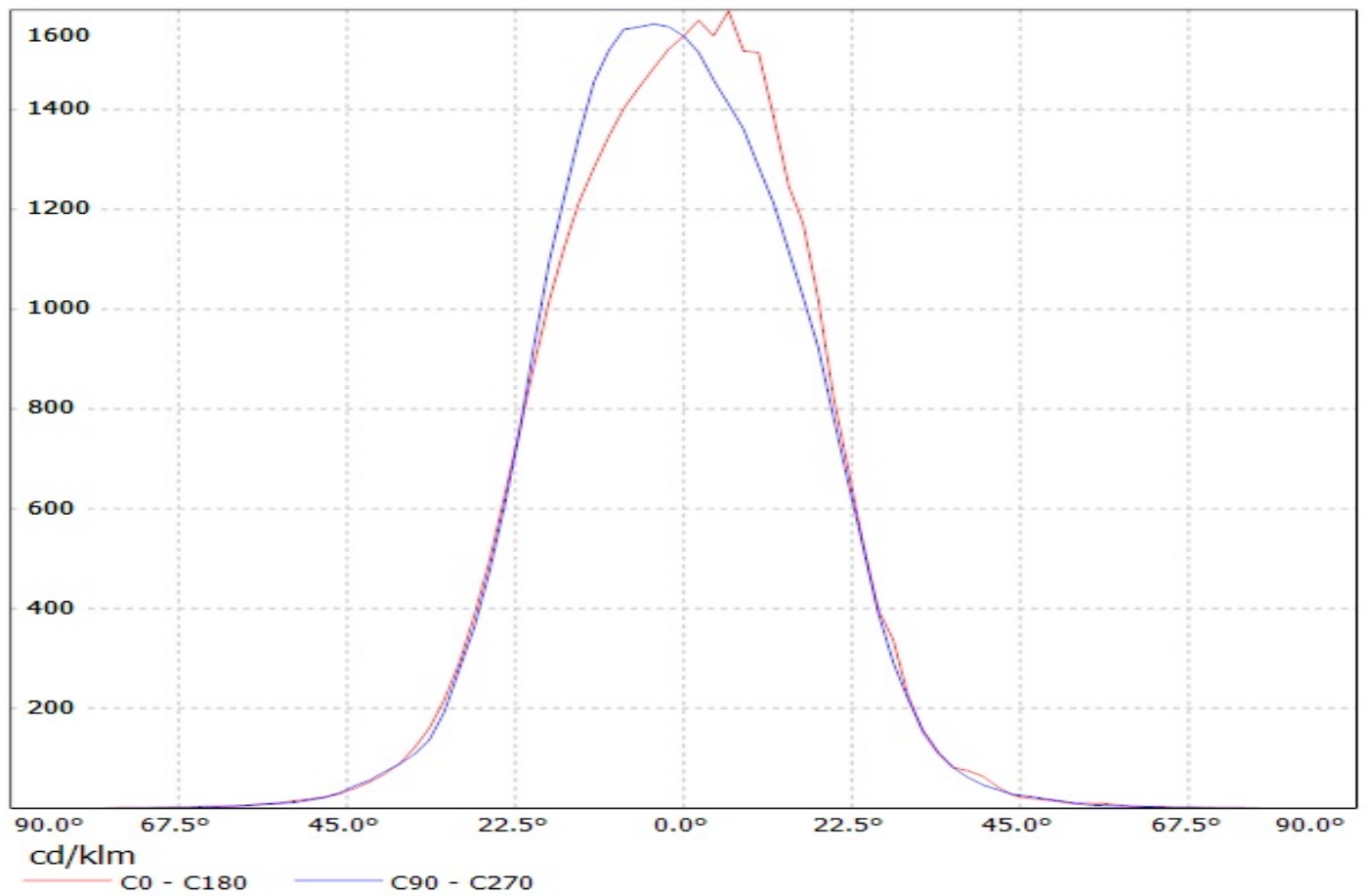

Luminaire: Ledil Oy CA12392\_LXP2-W\_(XP-G2) Efficiency=87%  
Lamps: 1 x Cree XP-G2 (104lm@250mA) CCT=6600K P=0.8W I=250mA

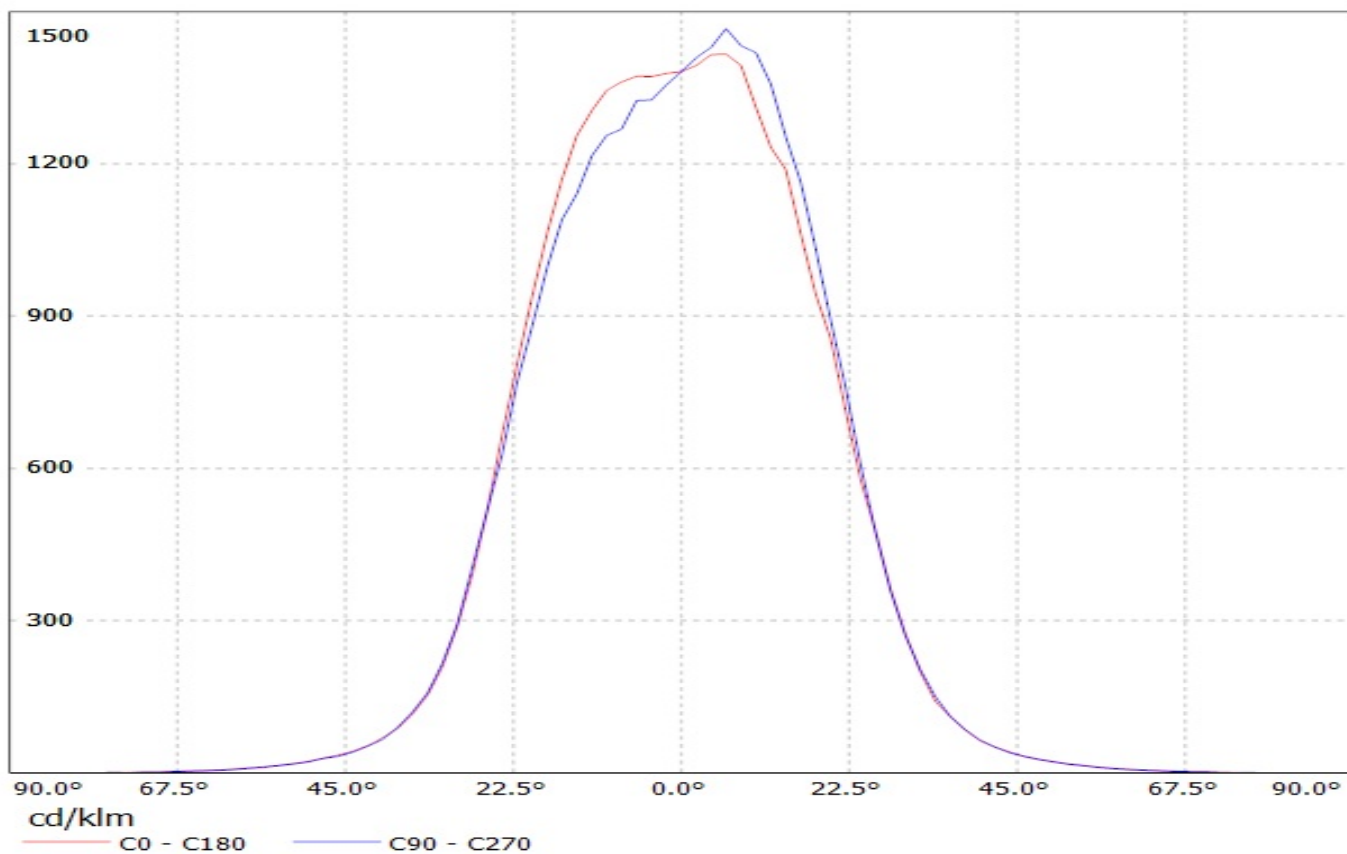

# LEDiL Oy CA12392 LXP2-W\_(XP-E2) Eff.87.1% / LDC (Linear)

Luminaire: LEDiL Oy CA12392 LXP2-W\_(XP-E2) Eff.87.1%

Lamps: 1 x CREE\_XP-E2\_(XPEBWT-L1-7B4-Q4-0-01)\_80.62lm@250mA\_P=0.745802W\_I=249.9mA

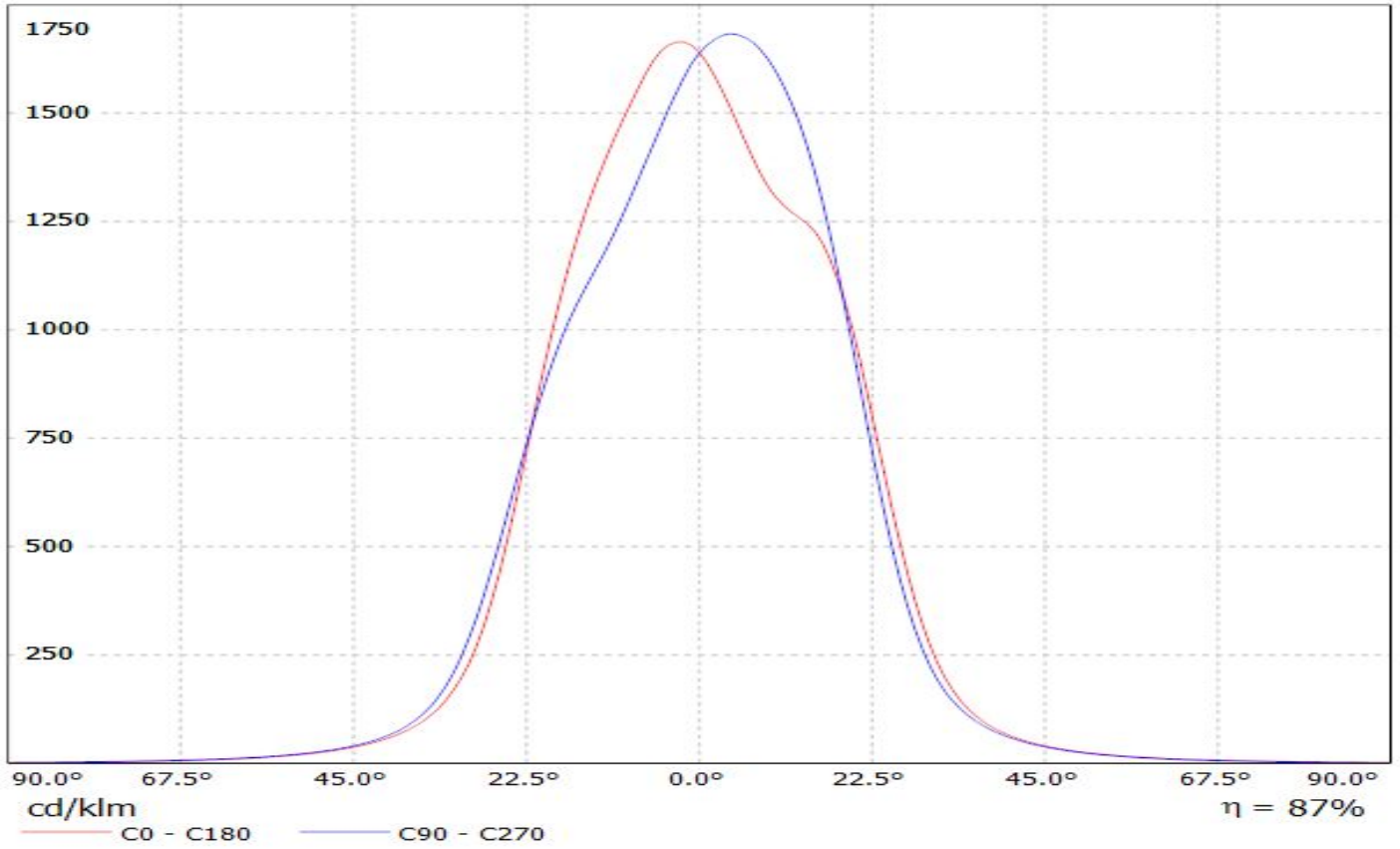

Luminaire: Ledil CA12392\_LXP2-W\_(XP-L\_HI)

Lamps: 1 x CREE\_XP-L\_HI\_116.971lm@250mA\_P=0.75W\_I=0.25A

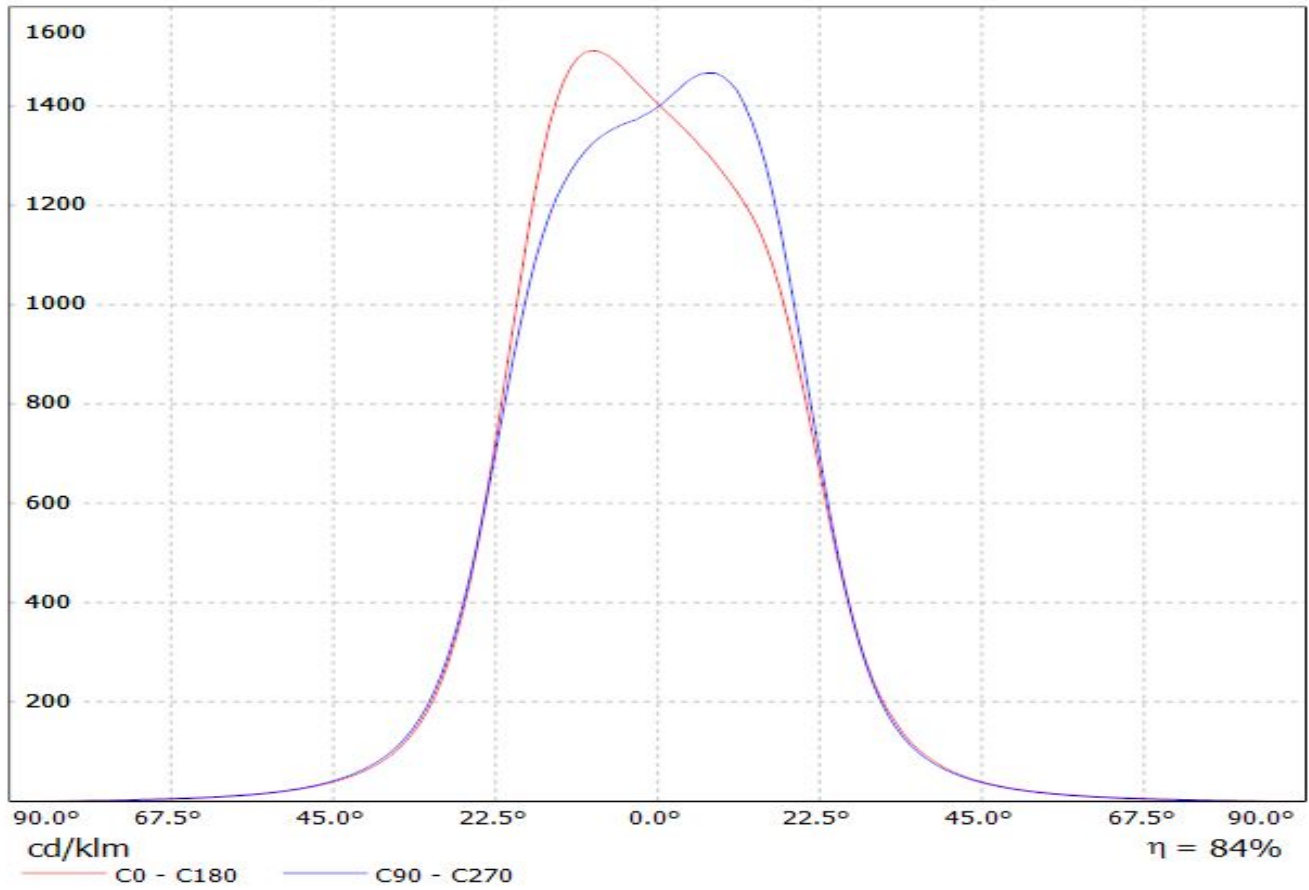



**LEDiL Oy CA12392\_LXP2-W\_(3535\_Ceramic)\_3 Eff.87.4% / LDC (Linear)**

Luminaire: LEDiL Oy CA12392\_LXP2-W\_(3535\_Ceramic)\_3 Eff.87.4%  
Lamps: 1 x LG 3535 Ceramic (95lm@250mA)

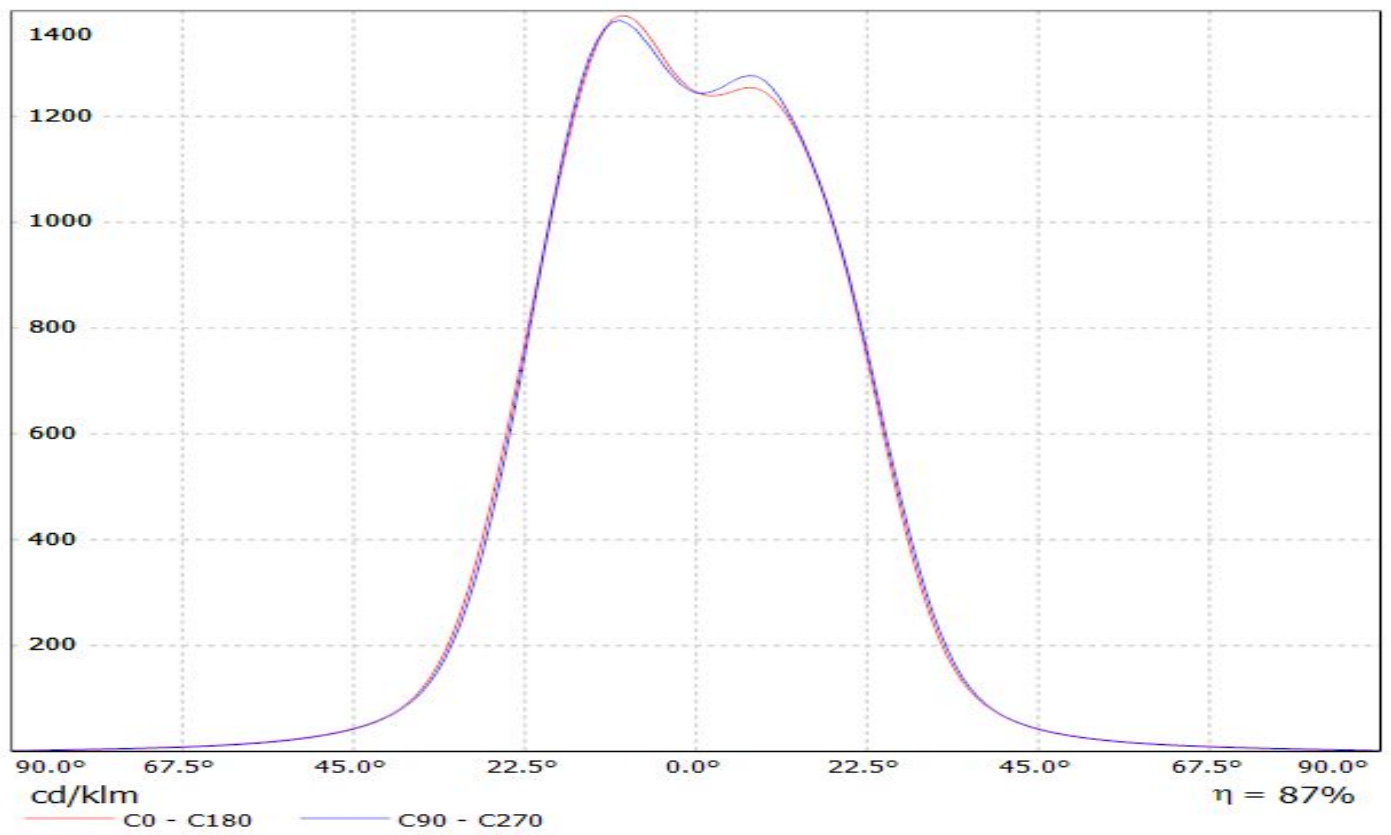

# LEDiL Oy CA12392\_LXP2-W\_(LG3535\_2W) Eff.87.2% / LDC (Linear)

Luminaire: LEDiL Oy CA12392\_LXP2-W\_(LG3535\_2W) Eff.87.2%  
Lamps: 1 x LG3535\_2W (97.3629lm@250mA)

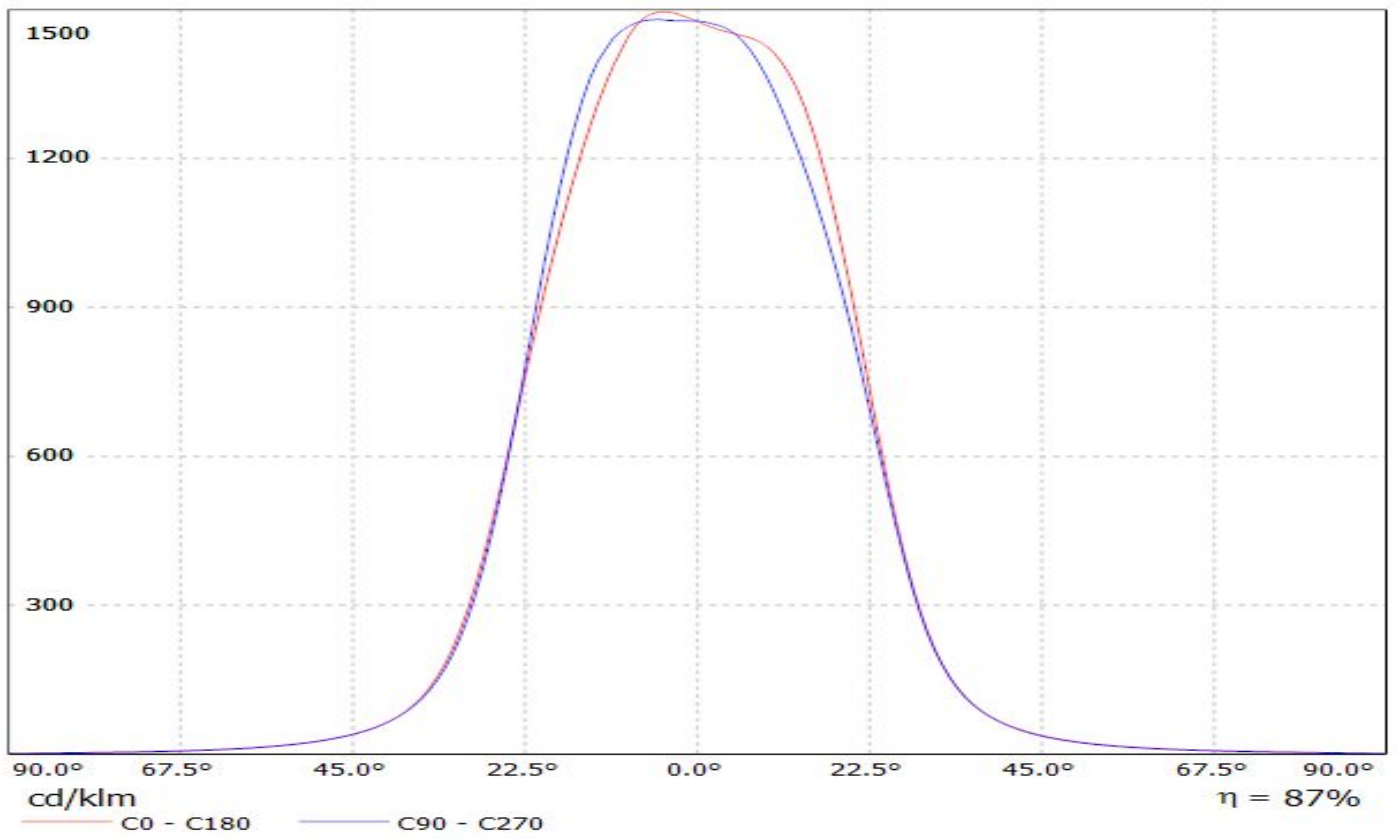

Luminaire: Ledil Oy CA12392\_LXP2-W\_(3535\_Ceramic\_gen2) Efficiency=90%  
Lamps: 1 x LG 3535 Ceramic gen2 (PKG5700K) 116lm @ 250mA CCT=6200K P=0.7W I=250mA

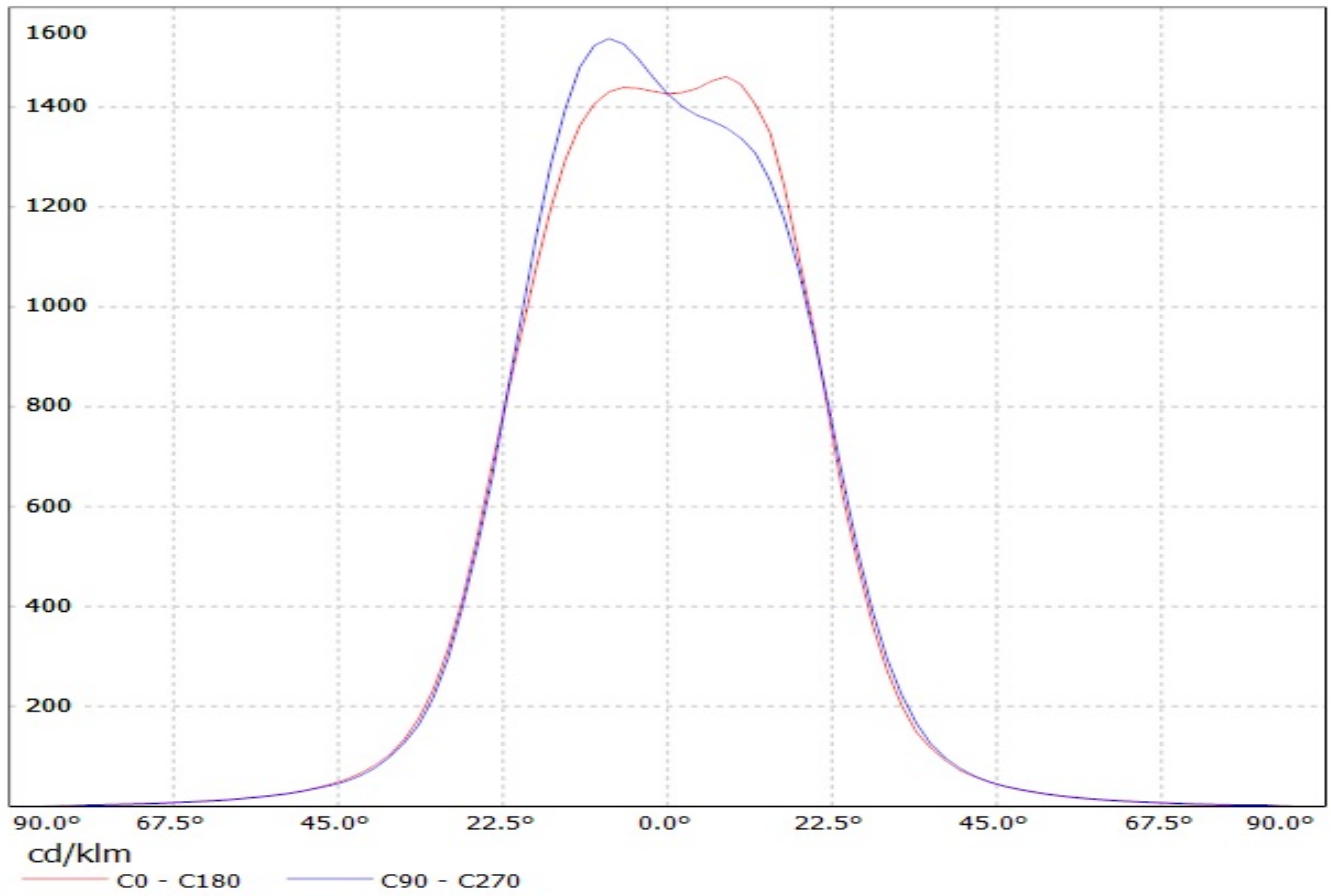

Luminaire: LEDiL Oy CA12392\_LXP2-W\_(LUXEON\_Q) Eff.84.8%  
Lamps: 1 x LUXEON\_Q\_(LHQ-3080)\_76.0112lm@250mA\_P=0.753249W\_I=249.9mA

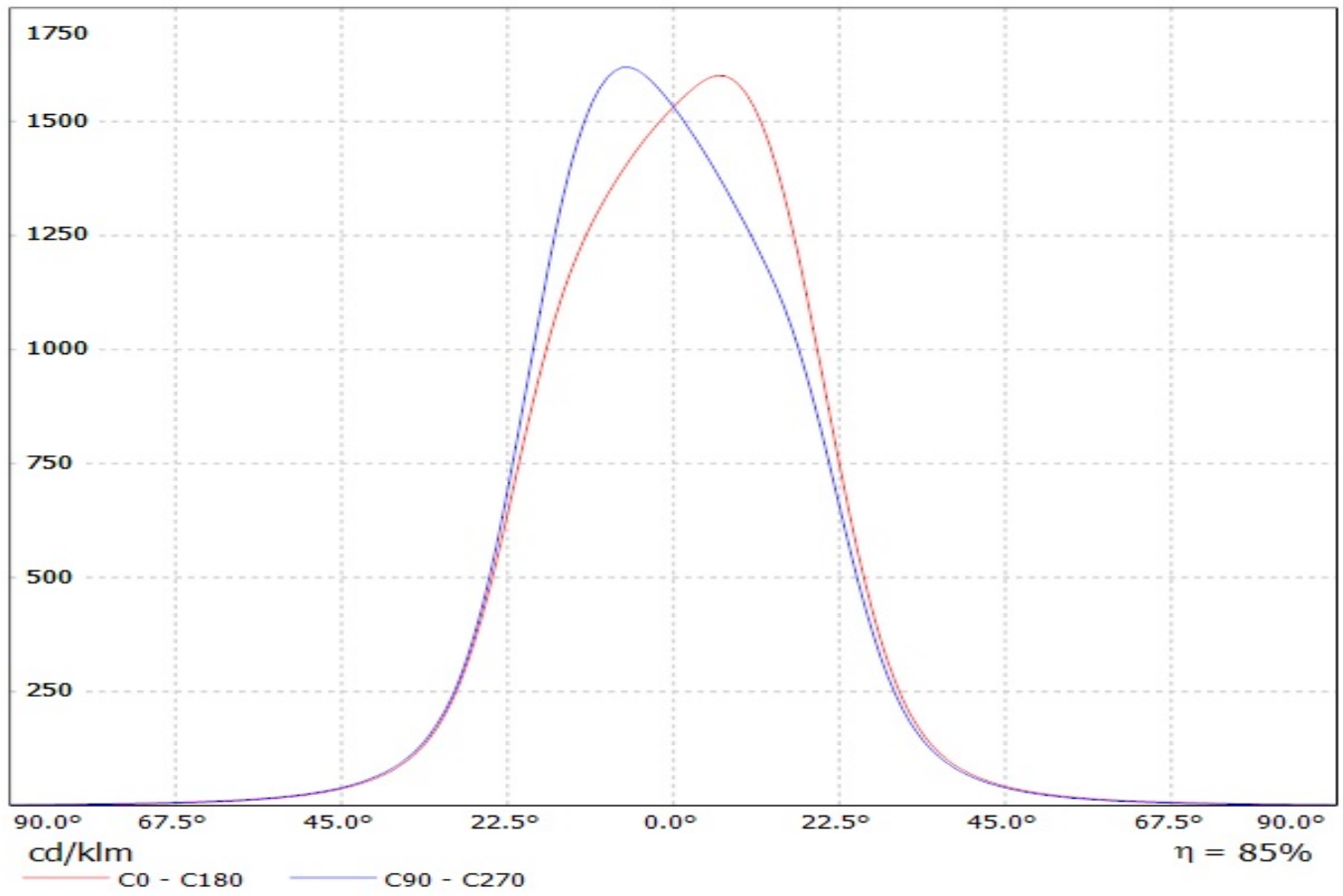

Luminaire: Ledil Oy CA12392\_LXP2-W (Seoul Z5 77lm @ 250mA) Efficiency=93%  
Lamps: 1 x Seoul Z5 77lm @ 250mA

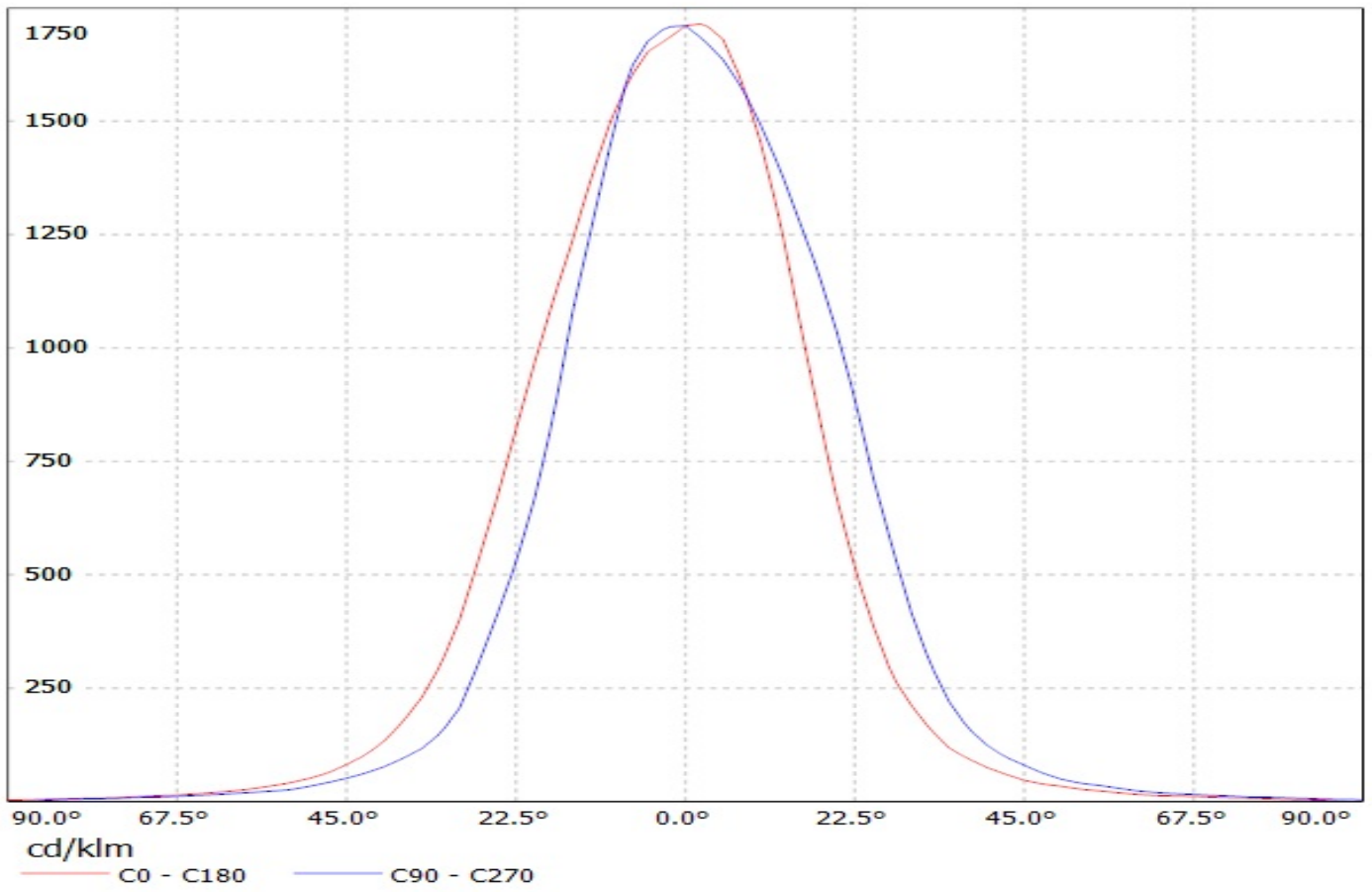

Luminaire: LEDil Oy CA12392\_LXP2-W\_(Z5M1) Efficiency=86%  
Lamps: 1 x Seoul Z5M1 (SZ5M1-W0-C8/W1-A5-G) 108lm @ 250mA CCT=9100K P=0.8W I=250mA

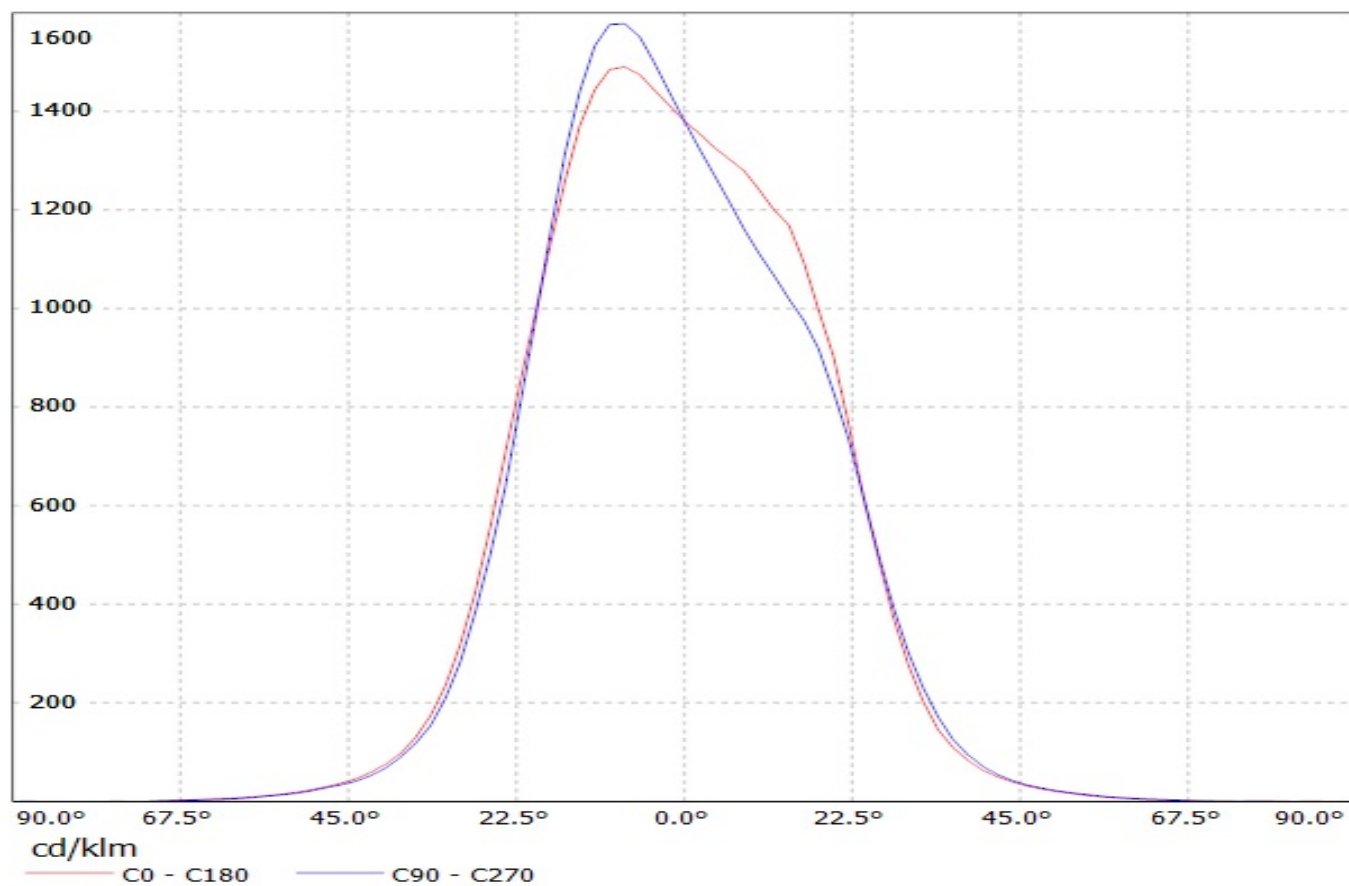

Luminaire: Ledil Oy CA12392\_LXP2-W\_SEOUL\_Z8Y22+\_SIMULATED  
Lamps: 1 x SEOUL Z8Y22 Plus

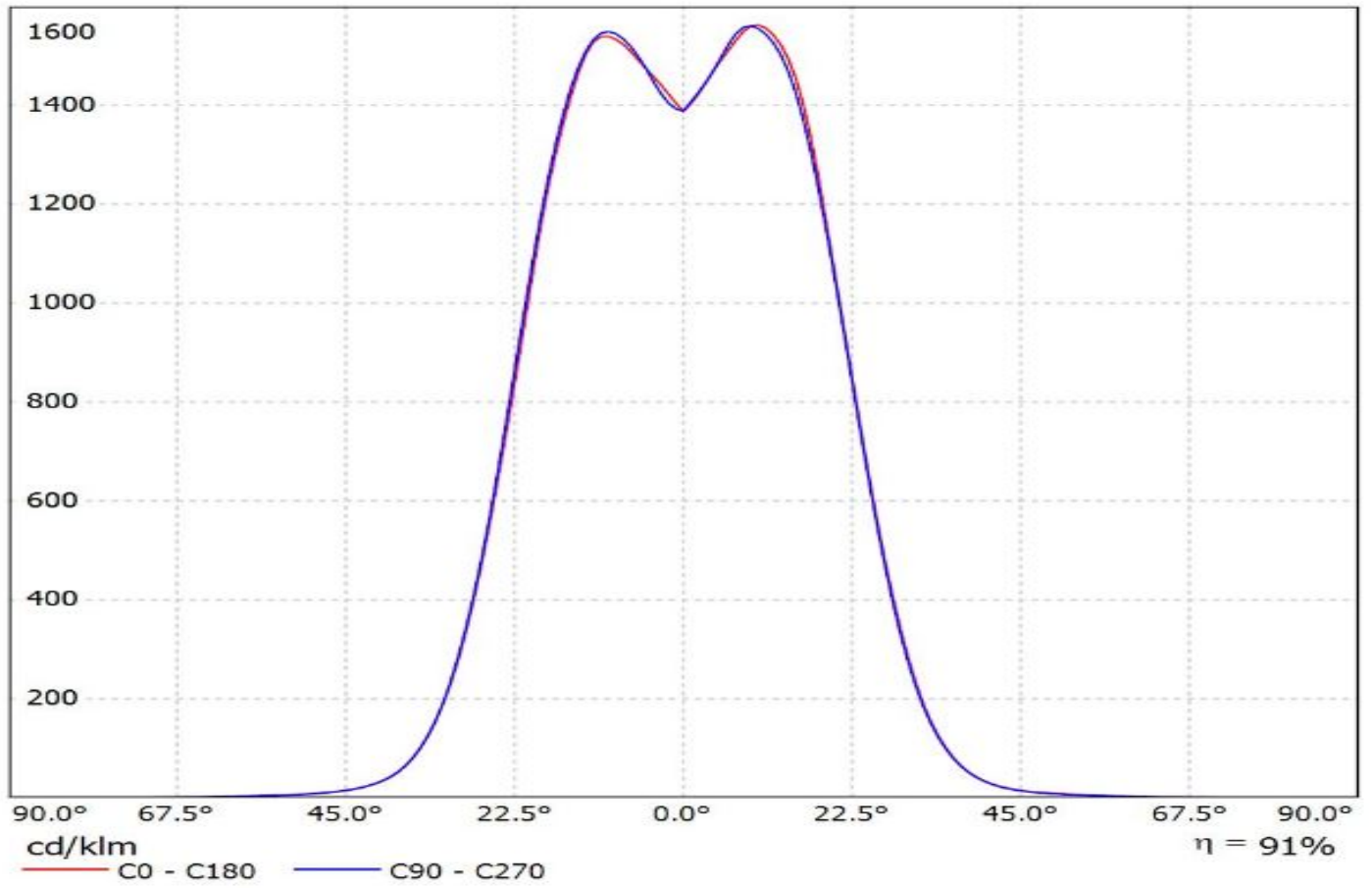

Luminaire: Ledil Oy CA12392\_LXP2-W (Cree XP-E 77lm @ 250mA) Efficiency=90%  
Lamps: 1 x Cree XP-E 77lm @ 250mA

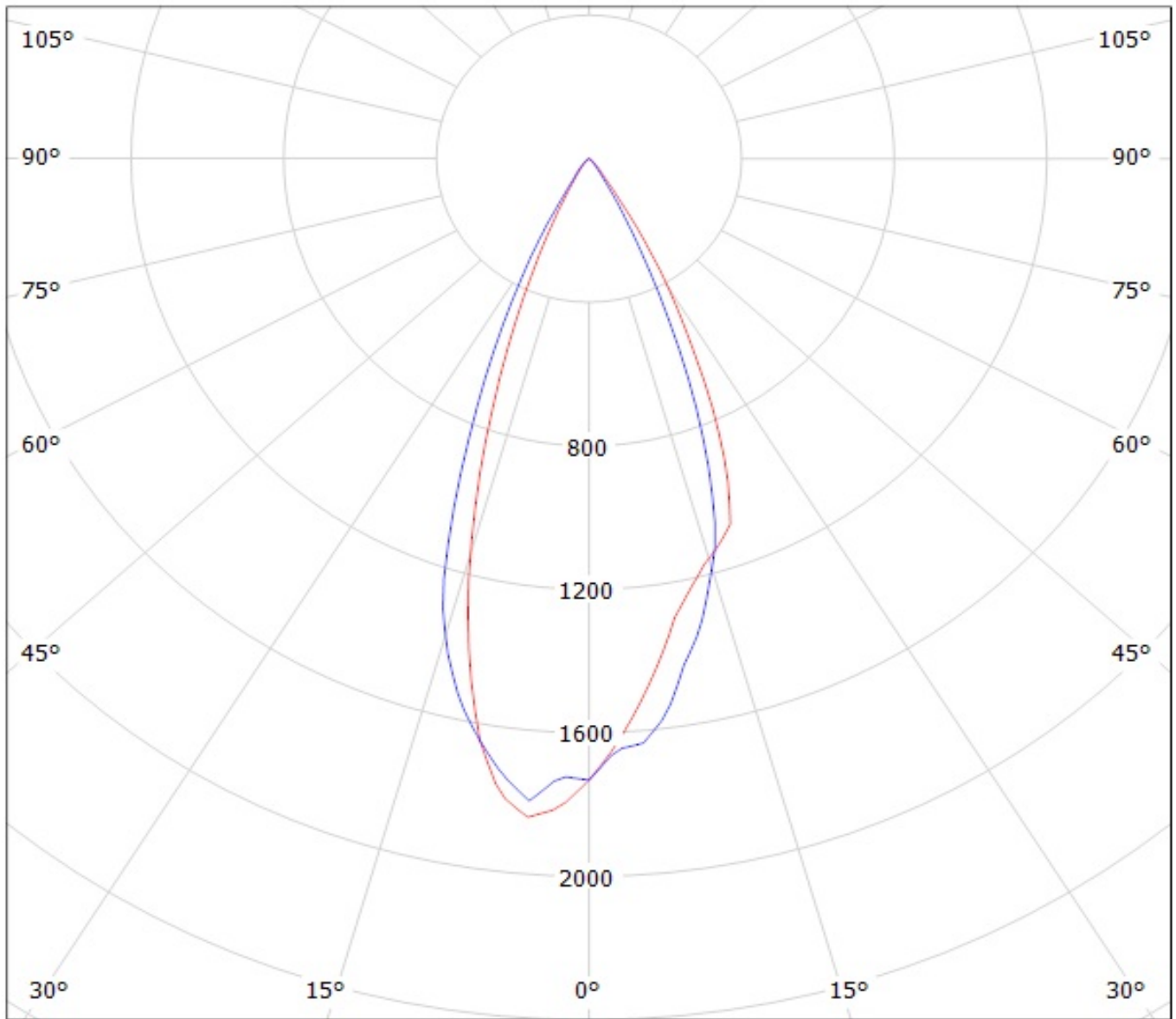

cd/klm

— C0 - C180    — C90 - C270



Luminaire: Ledil Oy CA12392\_LXP2-G-W (Cree XP-G 71lm @ 250mA) Efficiency=89%  
Lamps: 1 x Cree XP-G 89lm @ 250mA

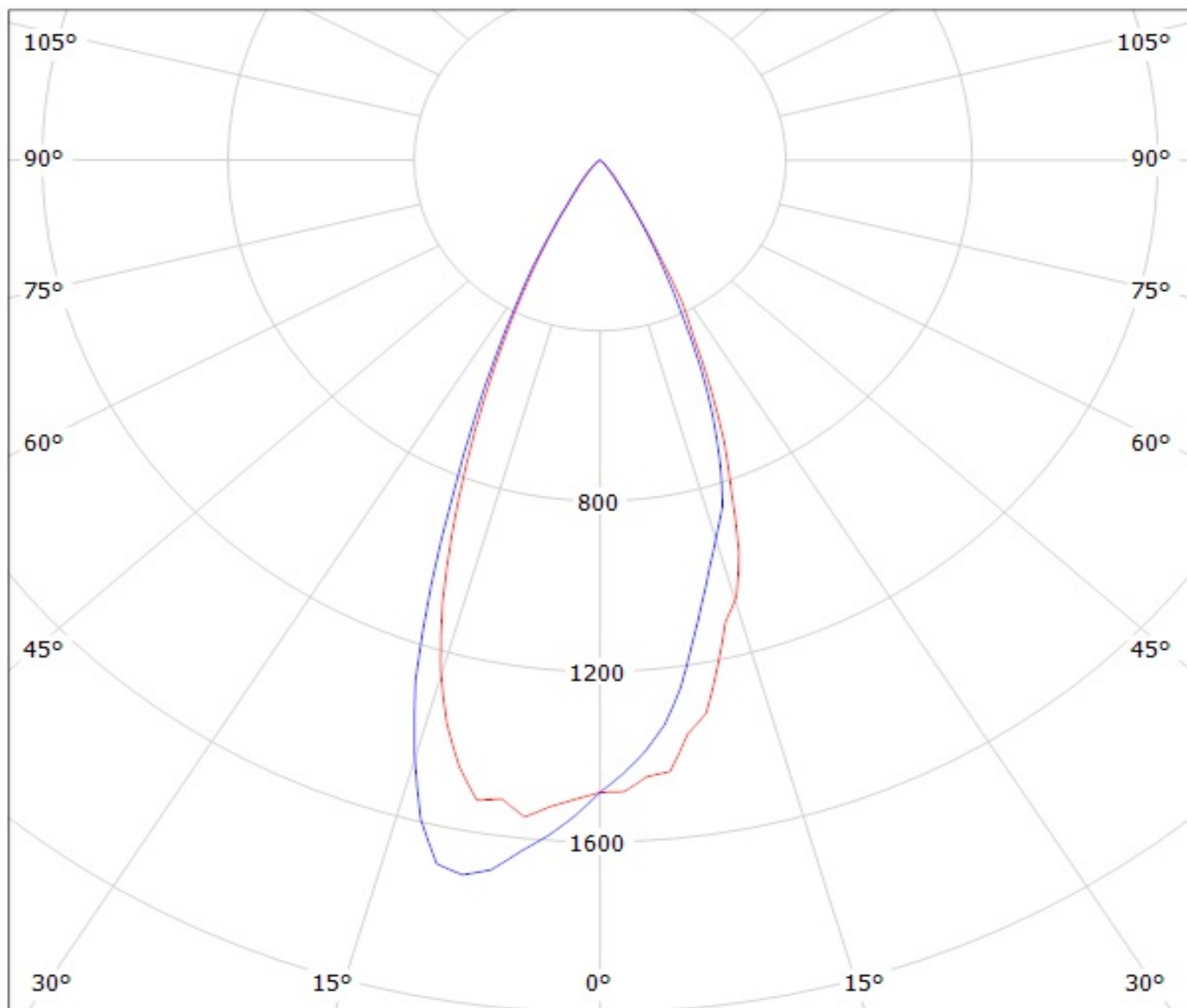

cd/klm

— C0 - C180    — C90 - C270

Luminaire: Ledil Oy CA12392\_LXP2-W-XT-E (CA12392\_LXP2-W-XT-E (AWT))

Lamps: 1 x XT-E 113lm @ 250mA

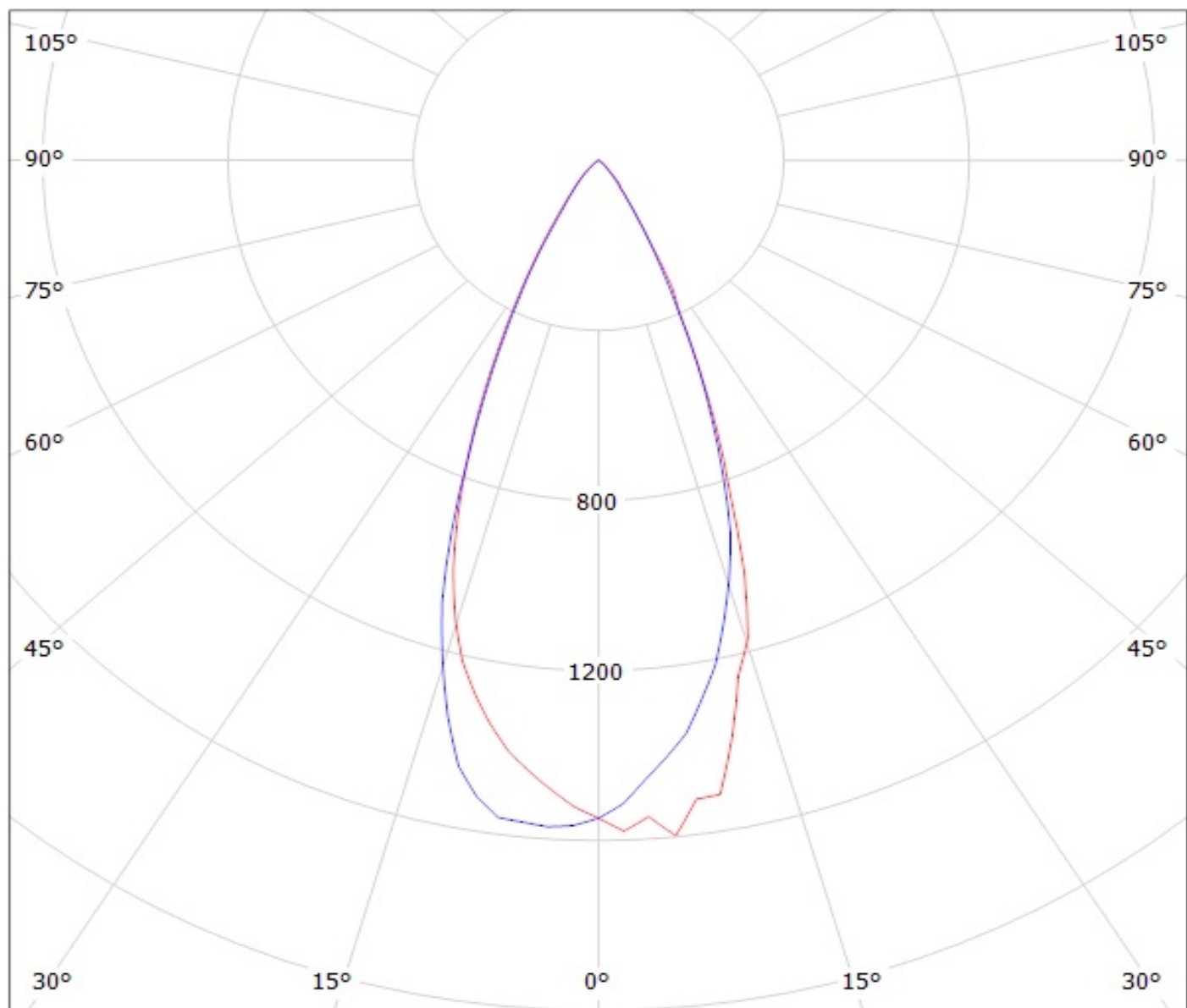

cd/klm

— C0 - C180

— C90 - C270

Luminaire: Ledil Oy CA12392\_LXP2-W\_(XP-G2) Efficiency=87%  
Lamps: 1 x Cree XP-G2 (104lm@250mA) CCT=6600K P=0.8W I=250mA

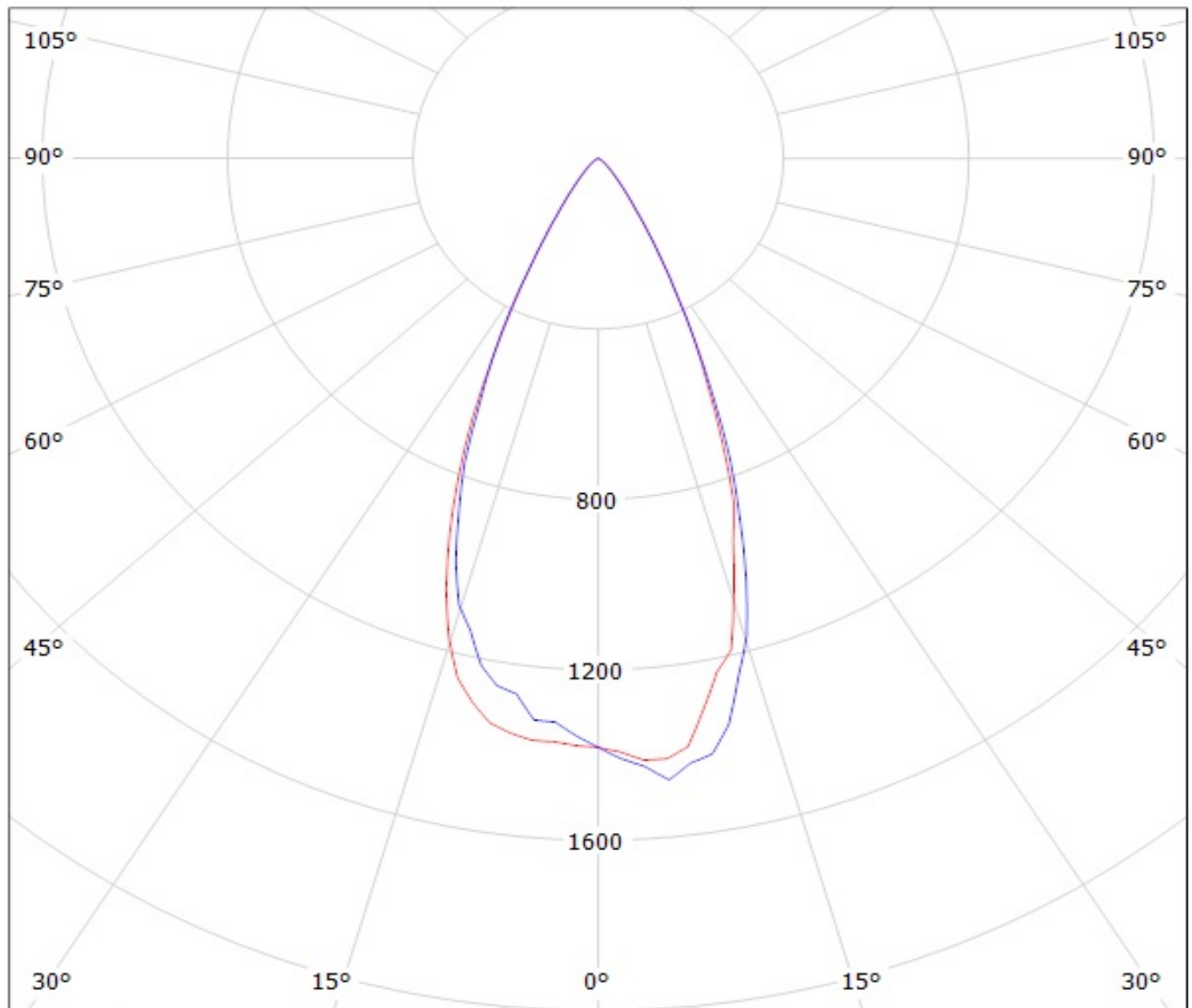

cd/klm

— C0 - C180

— C90 - C270

# LEDiL Oy CA12392 LXP2-W\_(XP-E2) Eff.87.1% / LDC (Polar)

Luminaire: LEDiL Oy CA12392 LXP2-W\_(XP-E2) Eff.87.1%

Lamps: 1 x CREE\_XP-E2\_(XPEBWT-L1-7B4-Q4-0-01)\_80.62lm@250mA\_P=0.745802W\_I=249.9mA

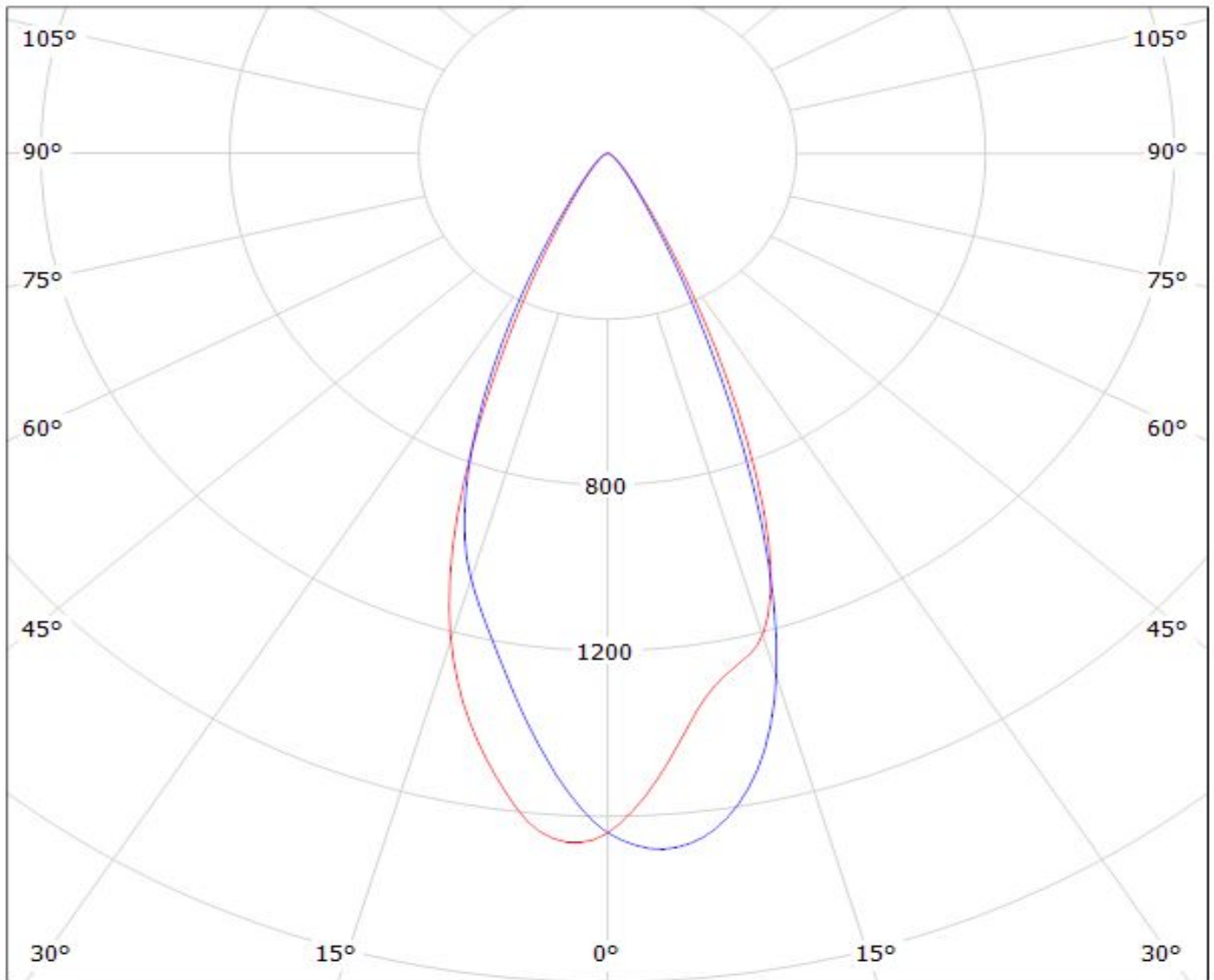

cd/klm

— C0 - C180

— C90 - C270

$\eta = 87\%$

Luminaire: Ledil CA12392\_LXP2-W\_(XP-L\_HI)

Lamps: 1 x CREE\_XP-L\_HI\_116.971lm@250mA\_P=0.75W\_I=0.25A

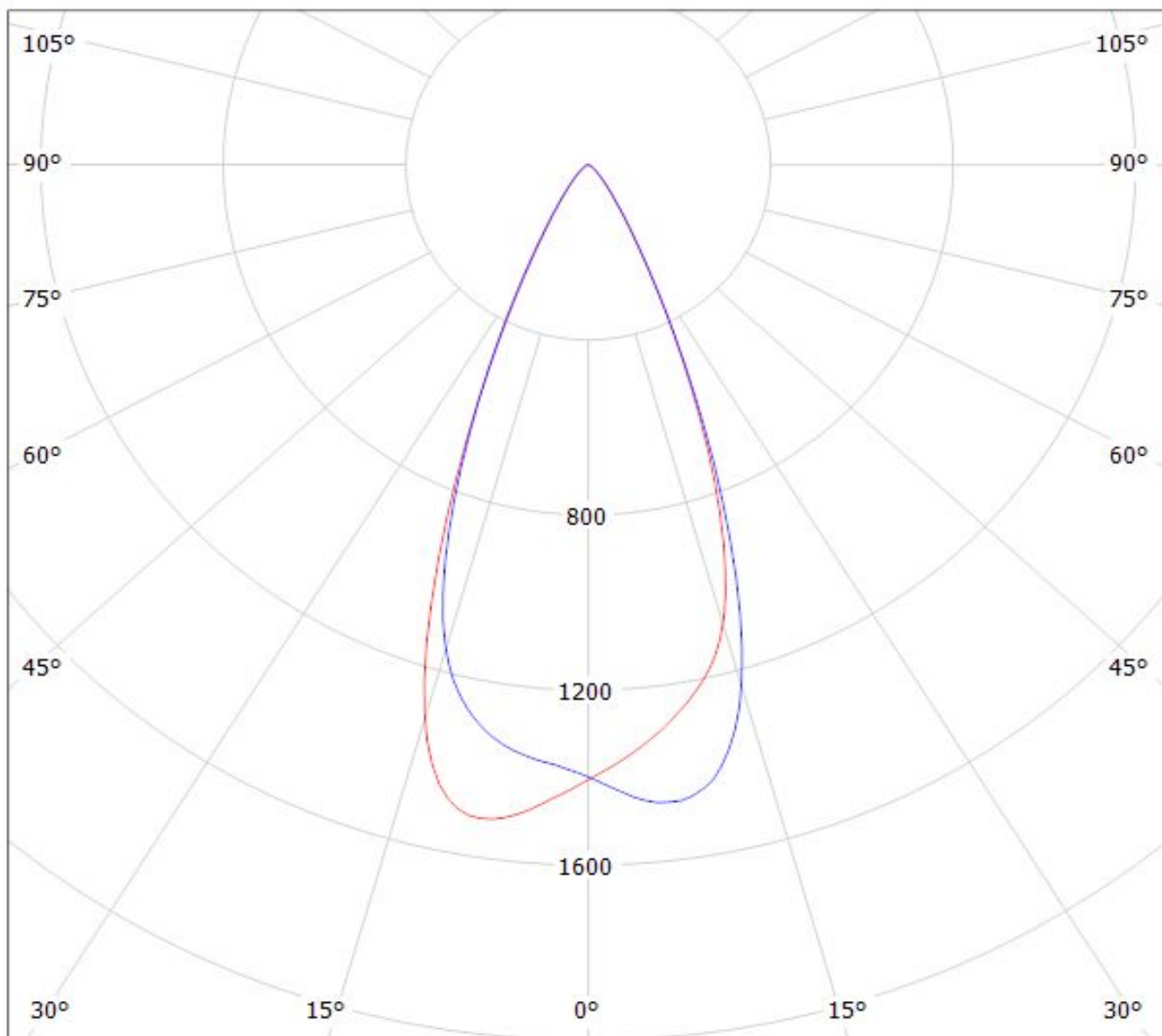

cd/klm

— C0 - C180

— C90 - C270

$\eta = 84\%$

# LEDiL Oy CA12392\_LXP2-W\_(3535\_Ceramic)\_3 Eff.87.4% / LDC (Polar)

Luminaire: LEDiL Oy CA12392\_LXP2-W\_(3535\_Ceramic)\_3 Eff.87.4%

Lamps: 1 x LG 3535 Ceramic (95lm@250mA)

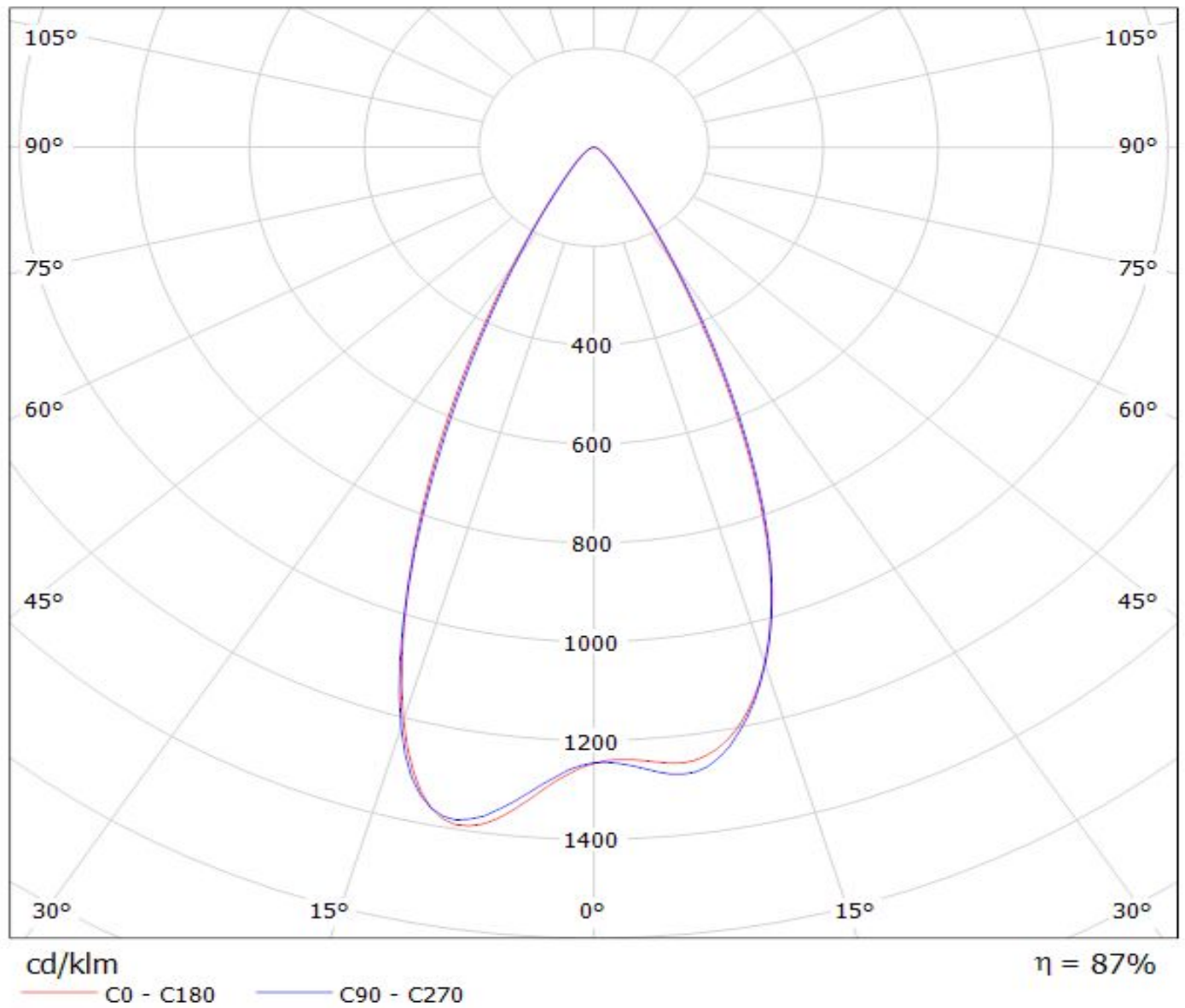

# LEDiL Oy CA12392\_LXP2-W\_(LG3535\_2W) Eff.87.2% / LDC (Polar)

Luminaire: LEDiL Oy CA12392\_LXP2-W\_(LG3535\_2W) Eff.87.2%

Lamps: 1 x LG3535\_2W (97.3629lm@250mA)

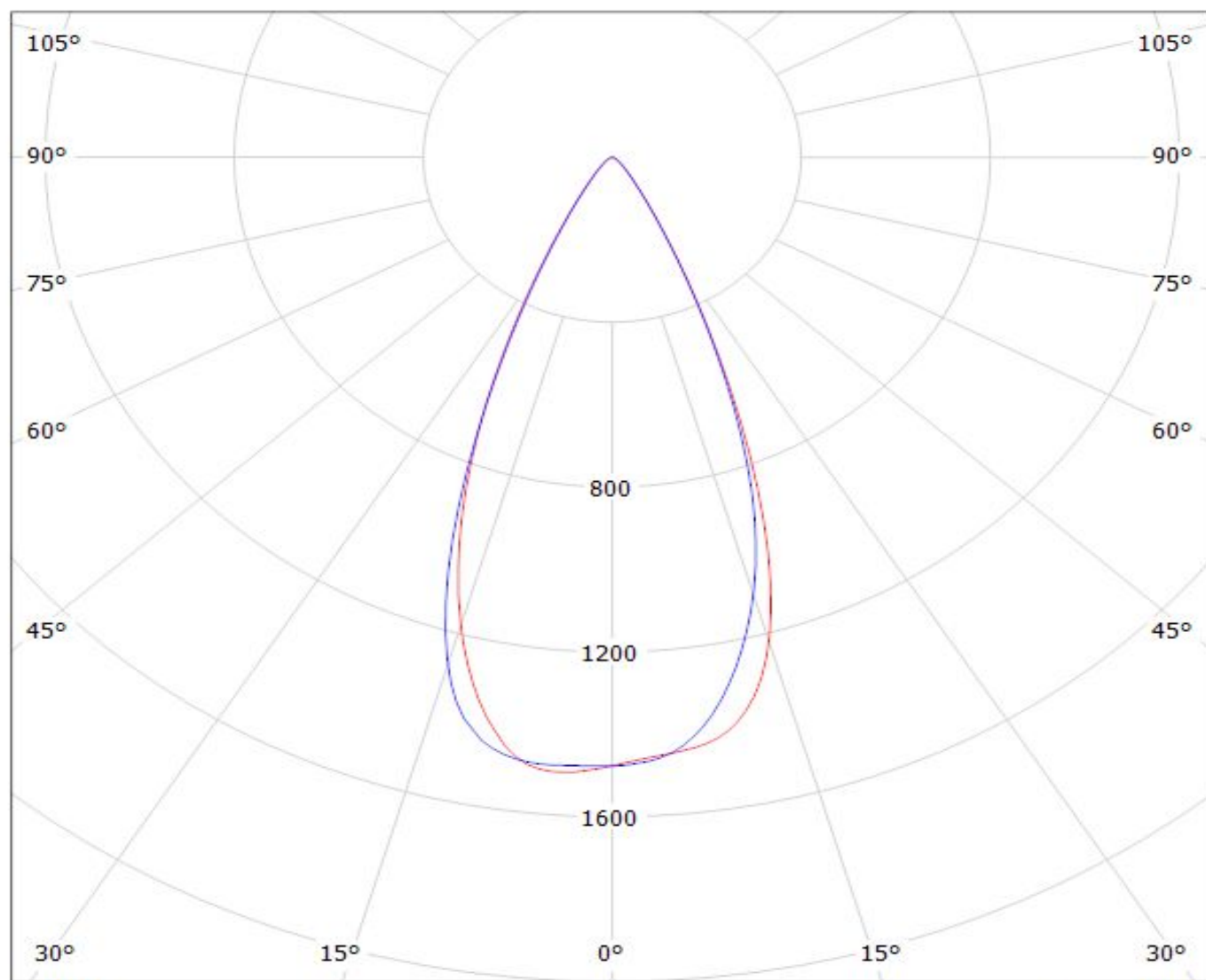

cd/klm

— C0 - C180

— C90 - C270

$\eta = 87\%$

Luminaire: Ledil Oy CA12392\_LXP2-W\_(3535\_Ceramic\_gen2) Efficiency=90%  
Lamps: 1 x LG 3535 Ceramic gen2 (PKG5700K) 116lm @ 250mA CCT=6200K P=0.7W I=250mA

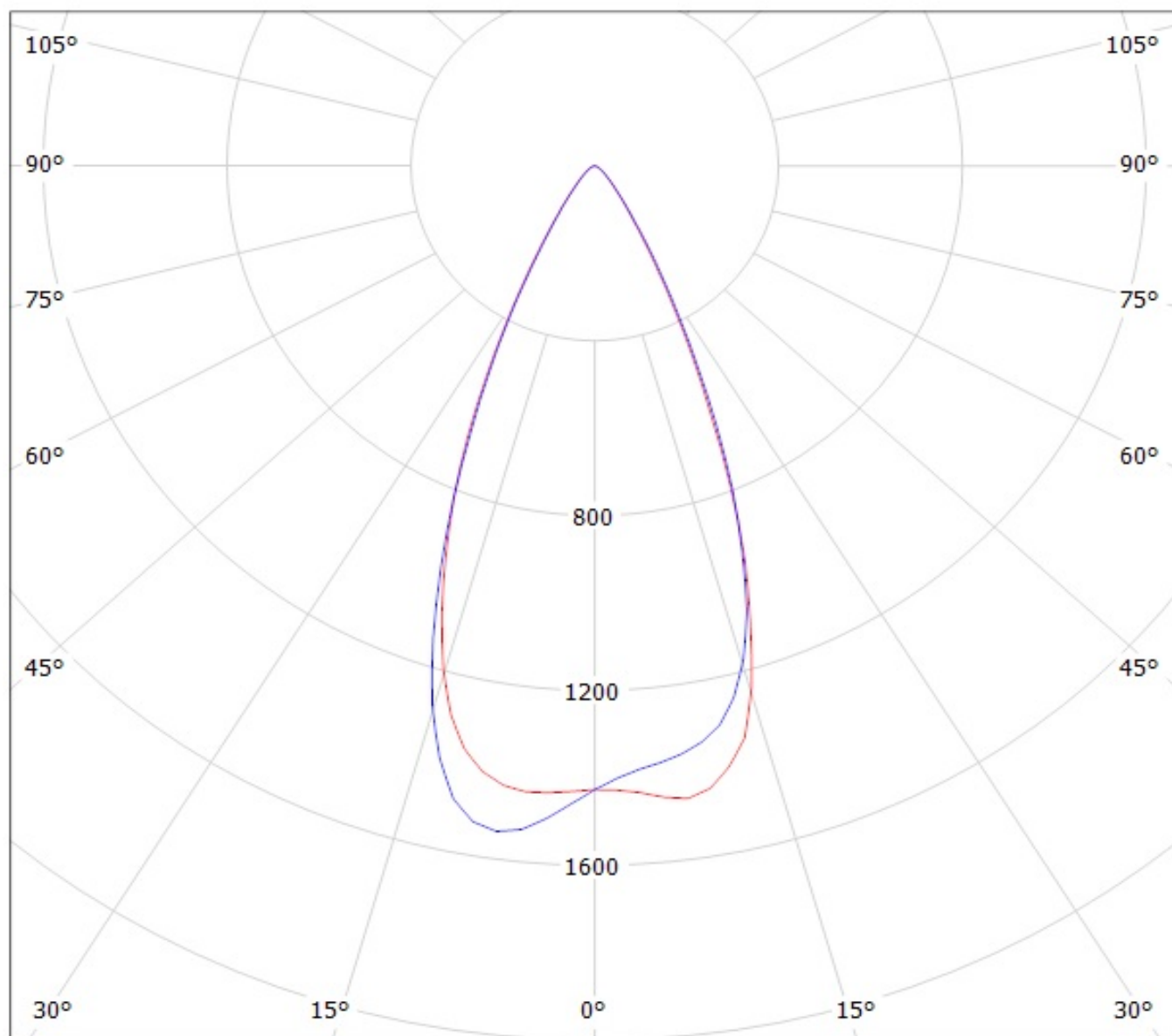

cd/klm

— C0 - C180    — C90 - C270



Luminaire: LEDiL Oy CA12392\_LXP2-W\_(LUXEON\_Q) Eff.84.8%

Lamps: 1 x LUXEON\_Q\_(LHQ-3080)\_76.0112lm@250mA\_P=0.753249W\_I=249.9mA

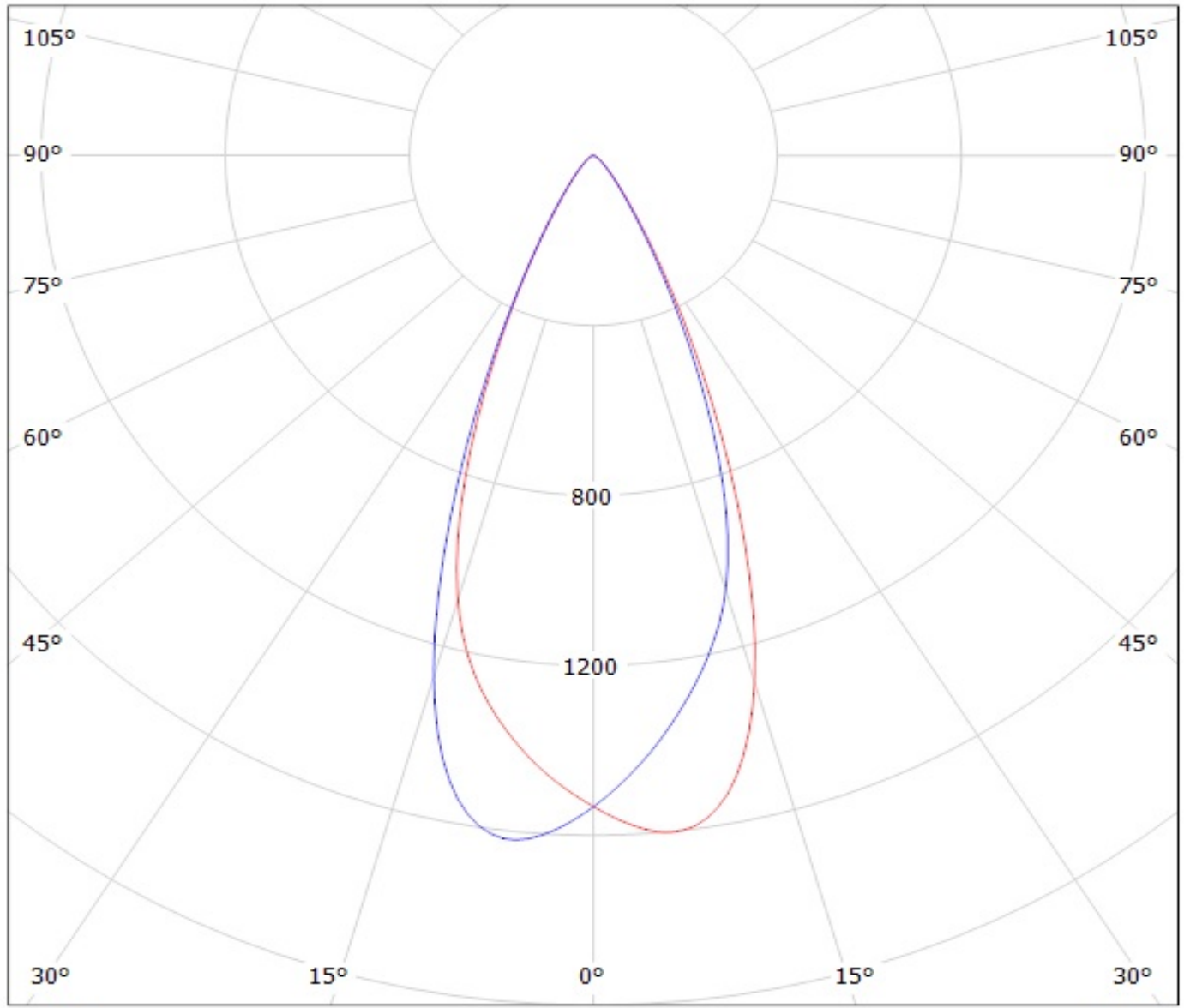

cd/klm

— C0 - C180

— C90 - C270

$\eta = 85\%$

Luminaire: Ledil Oy CA12392\_LXP2-W (Seoul Z5 77lm @ 250mA) Efficiency=93%  
Lamps: 1 x Seoul Z5 77lm @ 250mA

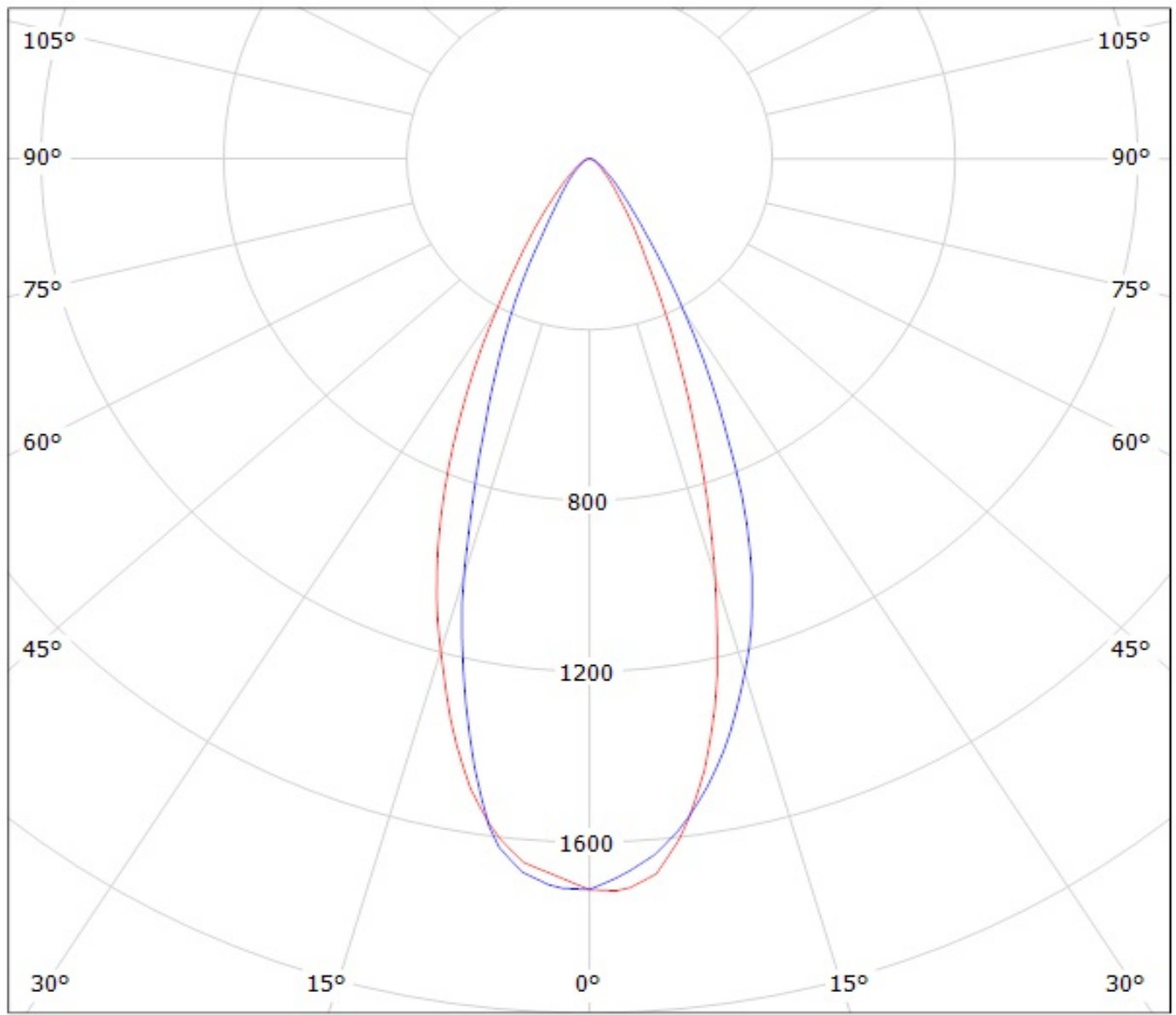

cd/klm

— C0 - C180

— C90 - C270

Luminaire: LEDil Oy CA12392\_LXP2-W\_(Z5M1) Efficiency=86%

Lamps: 1 x Seoul Z5M1 (SZ5M1-W0-C8/W1-A5-G) 108lm @ 250mA CCT=9100K P=0.8W I=250mA

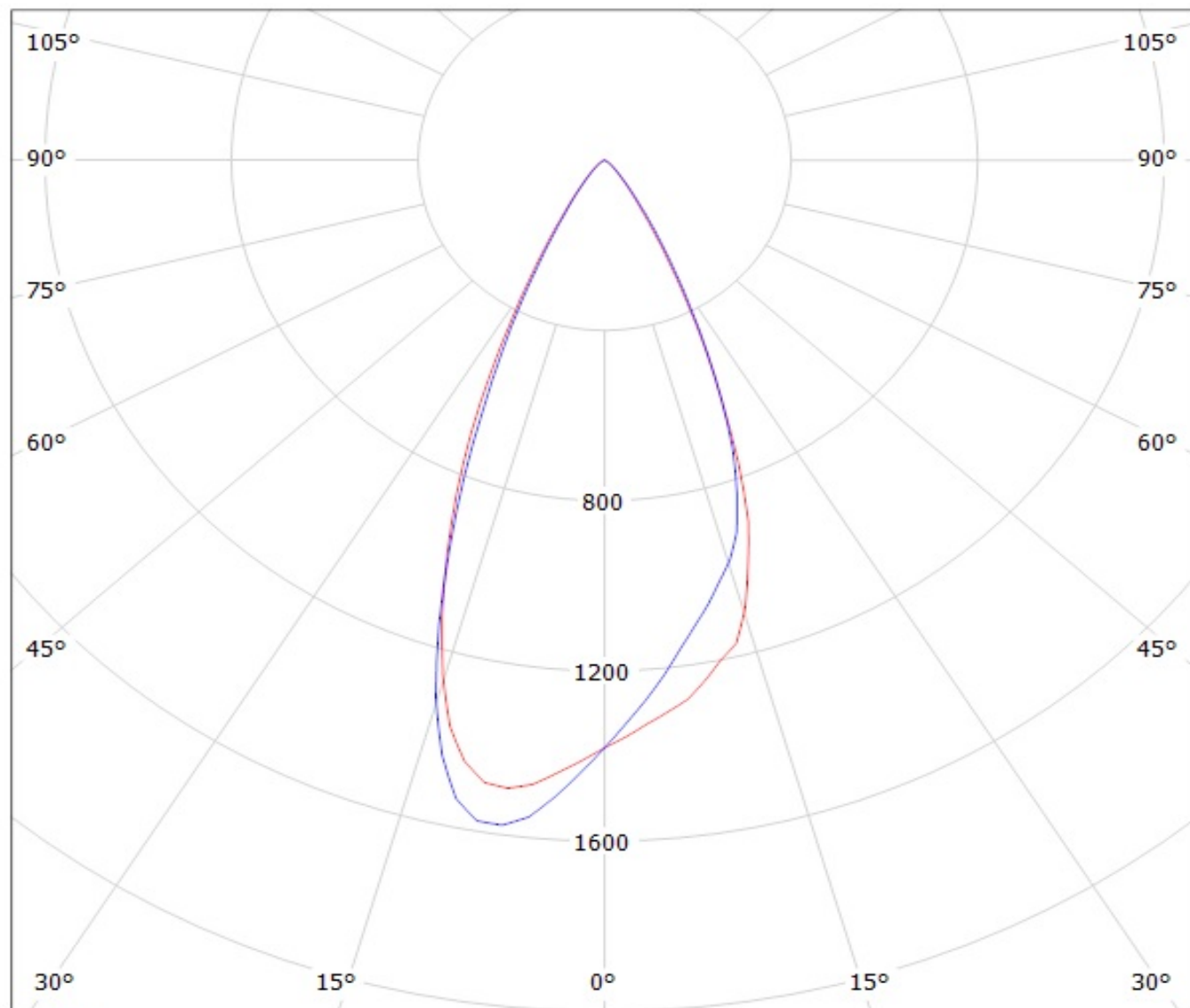

cd/klm

— C0 - C180

— C90 - C270

Luminaire: Ledil Oy CA12392\_LXP2-W\_SEOUL\_Z8Y22+\_SIMULATED  
Lamps: 1 x SEOUL Z8Y22 Plus

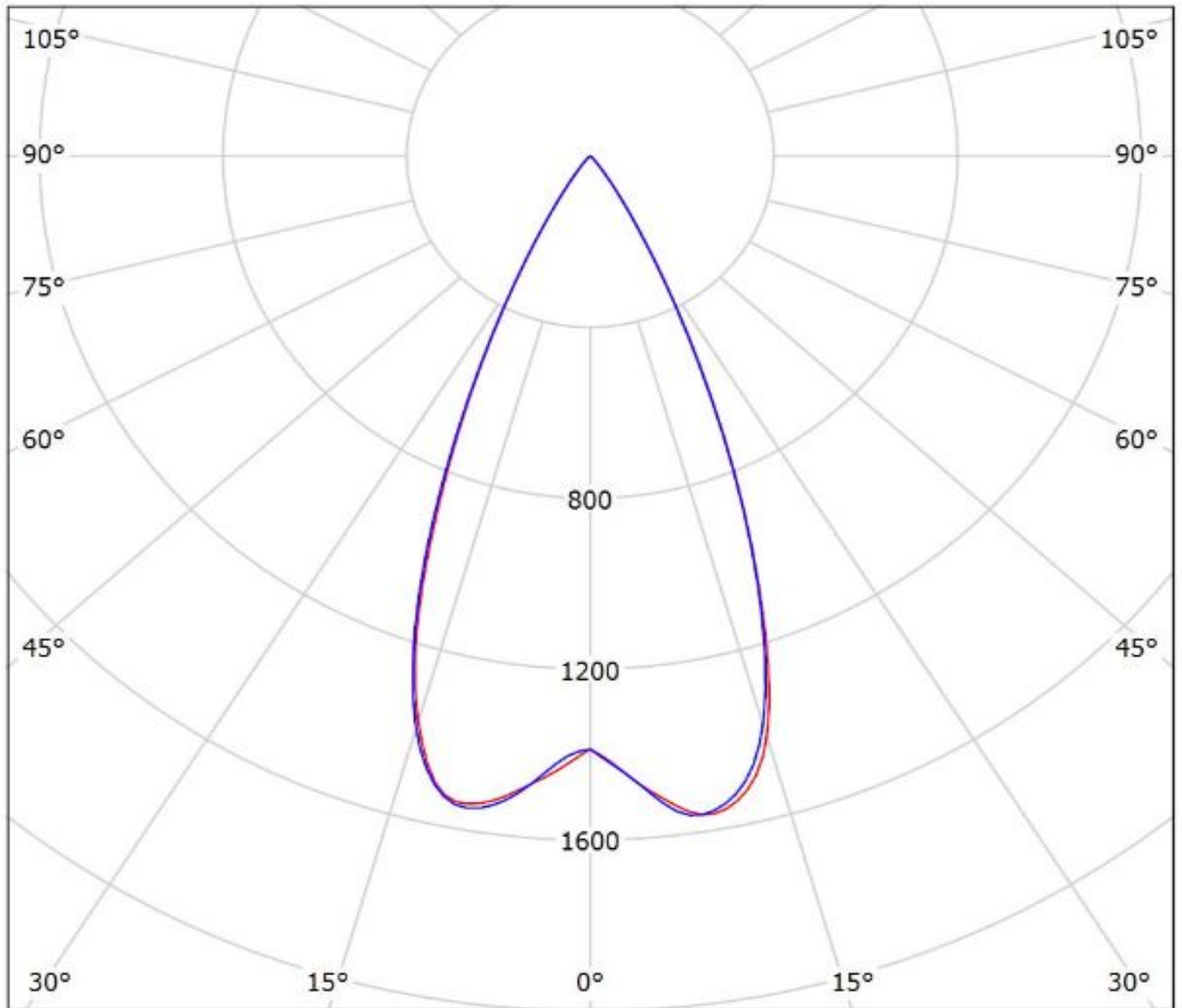

cd/klm

— C0 - C180 — C90 - C270

$\eta = 91\%$

**NOTE: The typical divergence will be changed by different color, chip size and chip position tolerance. The typical total divergence is the full angle measured where the luminous intensity is half of the peak value.**