



Features

- Frequency Range 50MHz to 1000MHz
- 6-Bit Digital Step Attenuator
- SPI Serial Control Programming
- Max Gain=38.5dB at 150MHz
- Gain Control Range=31.5dB (0.5dB Step Size)
- Class 1C HBM ESD Rating
- High OIP3=42dBm at 150MHz
- High P1dB=20dBm at 150MHz
- Single +5V Supply
- Small 28-Pin, 6.0mmx6.0mm, MCM
- Power-up Programming

Applications

- Transceiver IF DVA
- Cellular, PCS, GSM, UMTS
- Wireless Data, Satellite Terminals

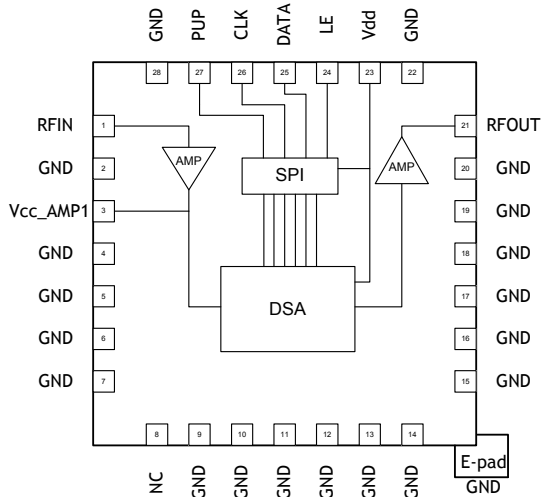

Functional Block Diagram

Product Description

RFMD's RFDA0016 is a digital controlled variable gain amplifier featuring high linearity over the entire gain control range. The 6-bit digital step attenuator is programmed via a serial mode control interface. The RFDA0016 is packaged in a 6mmx6mm leadless laminate MCM with plated through thermal vias for low thermal resistance. The amplifier's bias chokes and DC blocks are external allowing for optimum performance over specific bands within 50MHz to 1000MHz.

Optimum Technology Matching® Applied

- | | | | |
|---|--------------------------------------|--|------------------------------------|
| <input checked="" type="checkbox"/> GaAs HBT | <input type="checkbox"/> SiGe BiCMOS | <input checked="" type="checkbox"/> GaAs pHEMT | <input type="checkbox"/> GaN HEMT |
| <input type="checkbox"/> GaAs MESFET | <input type="checkbox"/> Si BiCMOS | <input checked="" type="checkbox"/> Si CMOS | <input type="checkbox"/> BIFET HBT |
| <input checked="" type="checkbox"/> InGaP HBT | <input type="checkbox"/> SiGe HBT | <input type="checkbox"/> Si BJT | <input type="checkbox"/> LDMOS |

RF MICRO DEVICES®, RFMD®, Optimum Technology Matching®, Enabling Wireless Connectivity™, PowerStart®, POLARIS™ TOTAL RADIO™ and UltimateBlue™ are trademarks of RFMD, LLC. BLUETOOTH is a trademark owned by Bluetooth SIG, Inc., U.S.A. and licensed for use by RFMD. All other trade names, trademarks and registered trademarks are the property of their respective owners. ©2006, RF Micro Devices, Inc.

Absolute Maximum Ratings

Parameter	Rating	Unit
DC Supply Voltage	+5.5	V
DC Supply Current	240	mA
Power Dissipation	1.2	W
Max Input RF Power	20	dBm
Operating Temperature (T _{CASE})	-40 to +85	°C
Storage Temperature	-40 to +150	°C
Junction Temperature (T _J)	150	°C
ESD Rating (HBM)	Class 1C	
Moisture Sensitivity Level	MSL 3	



Caution! ESD sensitive device.

Exceeding any one or a combination of the Absolute Maximum Rating conditions may cause permanent damage to the device. Extended application of Absolute Maximum Rating conditions to the device may reduce device reliability. Specified typical performance or functional operation of the device under Absolute Maximum Rating conditions is not implied.

RoHS status based on EUDirective2002/95/EC (at time of this document revision).

The information in this publication is believed to be accurate and reliable. However, no responsibility is assumed by RF Micro Devices, Inc. ("RFMD") for its use, nor for any infringement of patents, or other rights of third parties, resulting from its use. No license is granted by implication or otherwise under any patent or patent rights of RFMD. RFMD reserves the right to change component circuitry, recommended application circuitry and specifications at any time without prior notice.

Parameter	Specification			Unit	Condition
	Min.	Typ.	Max.		
Frequency Range	50		1000	MHz	
Gain - 150MHz (Max Gain State)		38.5		dB	Attenuation=0dB, 150MHz
Gain - 500MHz (Max Gain State)	34.5	38.0	39.5	dB	Attenuation=0dB, 500MHz
Gain Control Range		31.5		dB	
Step Accuracy	±(0.15 +5% attenuation setting)			dB	Major states, 500MHz
Output P1dB		19.7		dBm	Attenuation=0dB, 50MHz to 500MHz
Output IP3 - 150MHz		42		dBm	P _{OUT} =0dBm/tone, 1MHz spacing, 150MHz
Output IP3 - 500MHz		38		dBm	P _{OUT} =0dBm/tone, 1MHz spacing, 500MHz
Noise Figure		3.4		dB	Attenuation=0dB
Input Return Loss		20		dB	100MHz to 500MHz, slight degradation elsewhere
Output Return Loss		20		dB	100MHz to 500MHz, slight degradation elsewhere
Settling Time		250		ns	t _{RISE} , t _{FALL} (10%/90% RF)
Control Interface		6		bit	SPI interface
Impedance		50		Ω	
Supply Voltage	4.75	5.00	5.25	V	Recommended Operating Voltage
Total Supply Current	160	175	210	mA	Sum of V _{DD} , V _{CC_AMP1} , V _{CC_AMP2} (RFOUT)
Thermal Resistance		54		°C/W	

Notes:

- V_{DD}=5V, Logic Voltage=5V, T=25 °C
- Broadband Application Circuit

Typical Performance - 50MHz to 850MHz Broadband Application Circuit

Gain, Major States, 25C

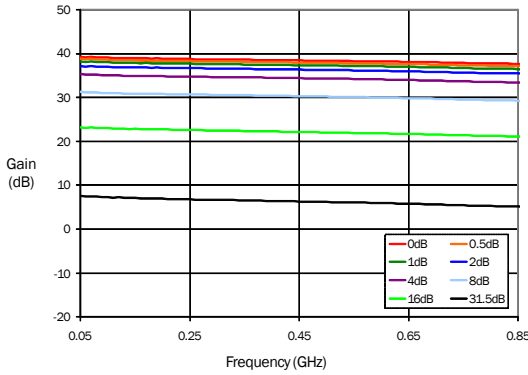

Gain versus Temperature, Max Gain

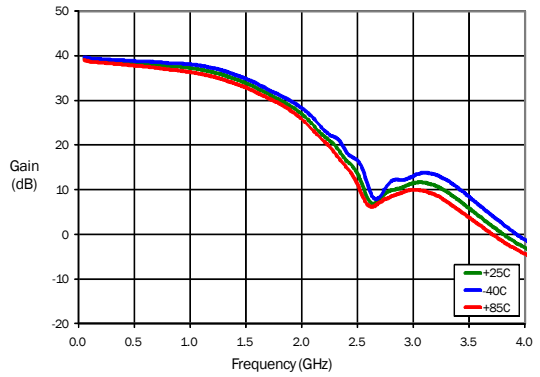

Input RL, Major States, 25C

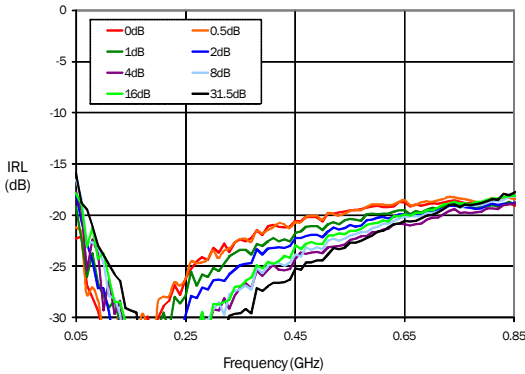

Input RL versus Temperature, Max Gain

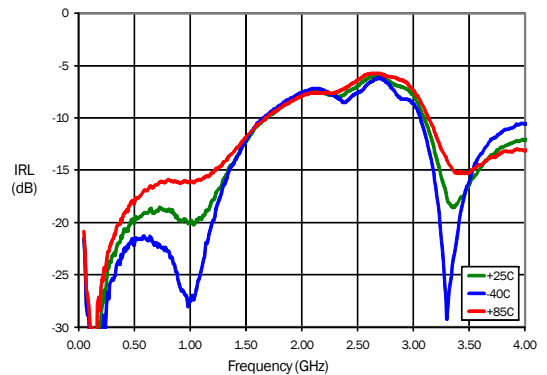

Output RL, Major States, 25C

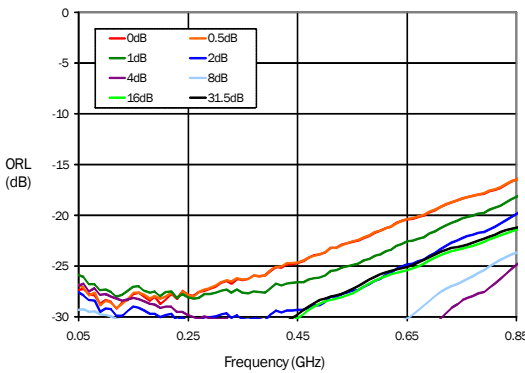

Output RL versus Temperature, Max Gain

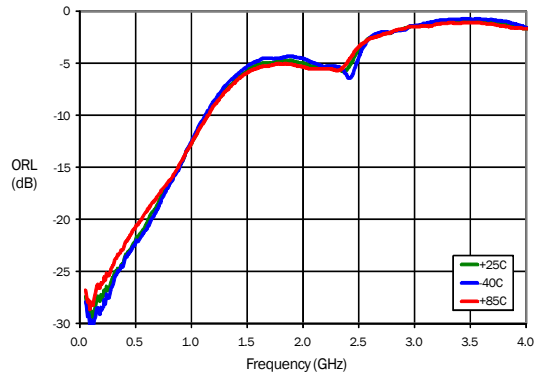

Isolation, Major States, 25C

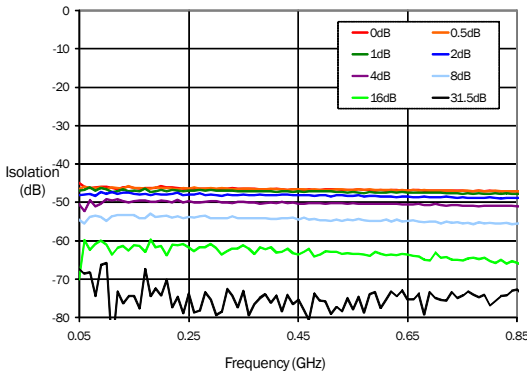

Isolation versus Temperature, Max Gain

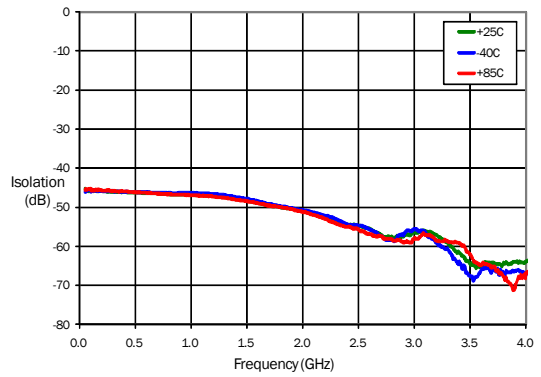

Attenuation Error, Major States, 25C

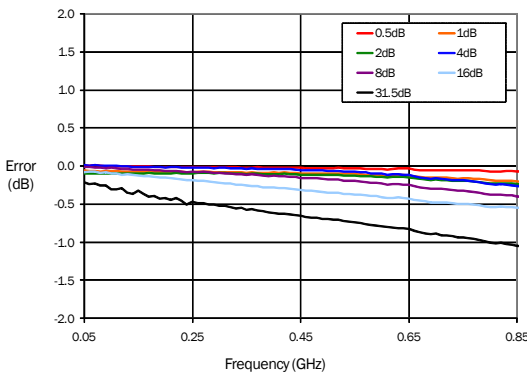

Relative Phase, Major States, 25C

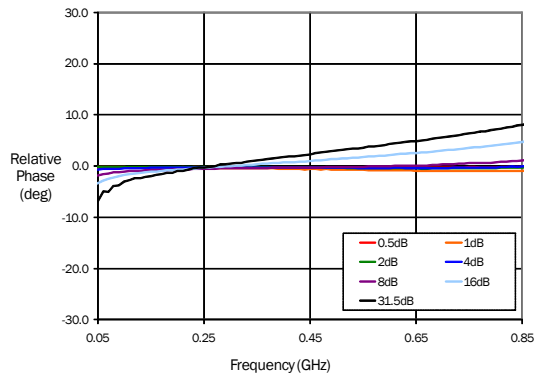

Worst Case Successive Step Error

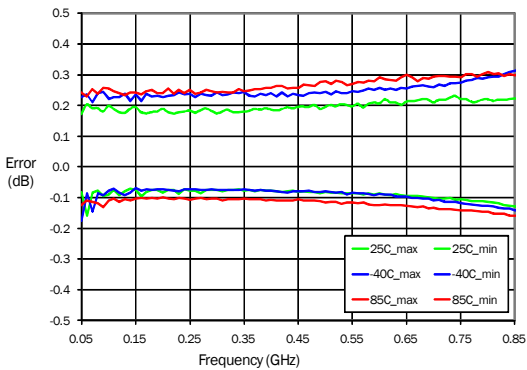

Successive Step Error versus Attenuation, 25C

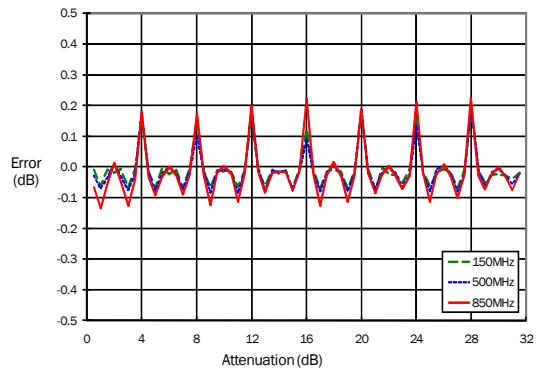

OIP3 versus Frequency, 25C, Major Steps

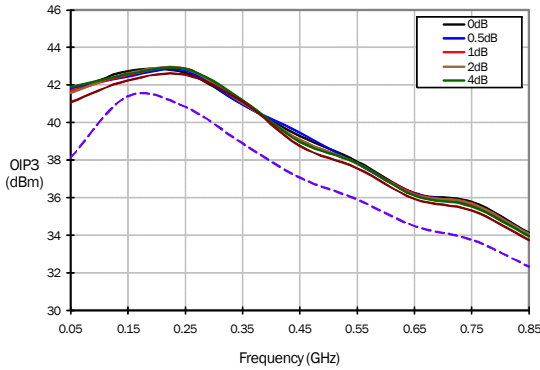

OIP3 versus P_{OUT}/Tone, 150MHz, Max Gain

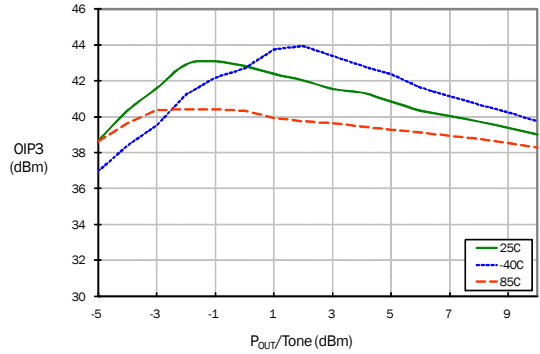

OIP3 versus Frequency, Max Gain

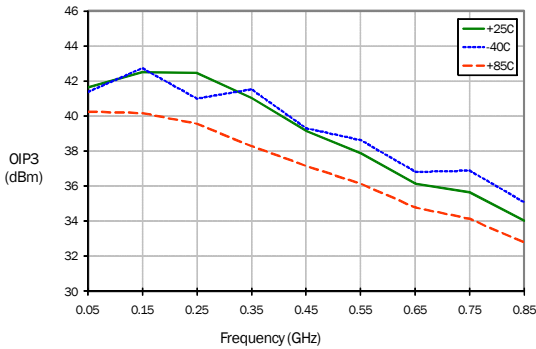

P1dB versus Frequency, Max Gain

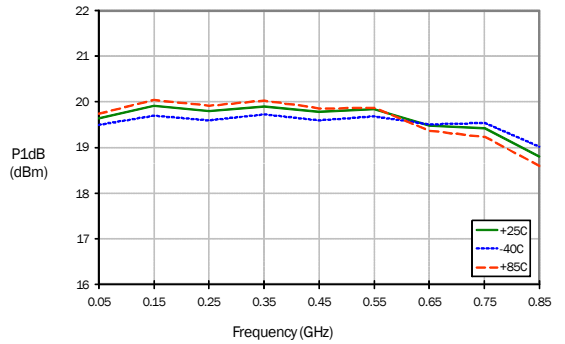

NF versus Frequency, Max Gain

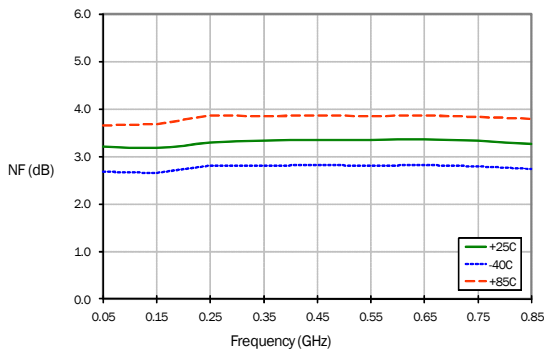

Current versus Voltage

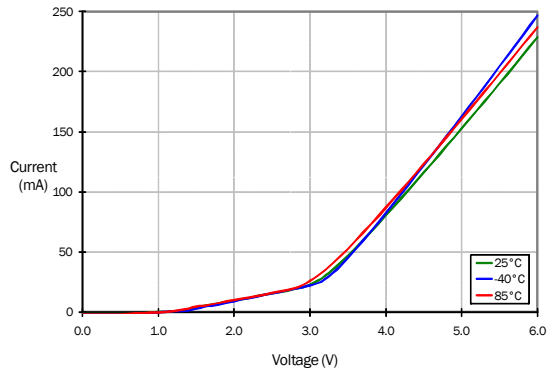

Control Bit						Gain Relative to Maximum Gain
D5	D4	D3	D2	D1	D0	
1	1	1	1	1	1	0dB
1	1	1	1	1	0	-0.5dB
1	1	1	1	0	1	-1dB
1	1	1	0	1	1	-2dB
1	1	0	1	1	1	-4dB
1	0	1	1	1	1	-8dB
0	1	1	1	1	1	-16dB
0	0	0	0	0	0	-31.5dB

Serial Port Interface

SPI Timing Diagram

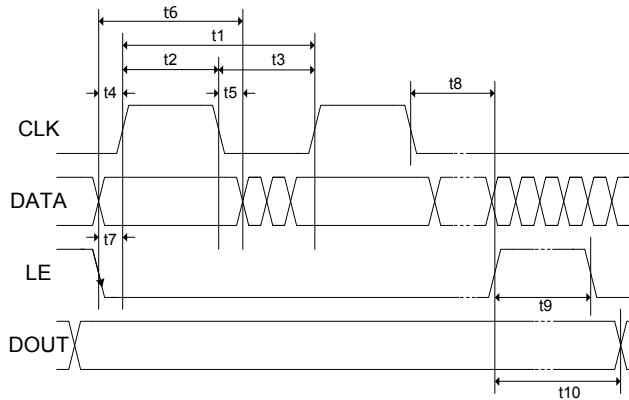

Programming example – 6 bit

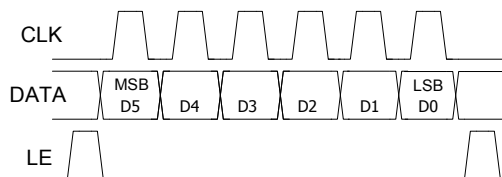

SPI Timing Diagram Specifications

Parameter	Limit	Unit	Comment
t1	25	MHz max	CLK Frequency
t2	20	ns min	CLK High
t3	20	ns min	CLK Low
t4	5	ns min	DATA to CLK Setup time
t5	5	ns min	DATA to CLK Hold time
t6	30	ns min	DATA Valid
t7	5	ns min	LE to CLK Setup time
t8	5	ns min	CLK to LE Setup time
t9	10	ns min	LE pulse width
t10	20	ns max	Output set

Logic Voltage Levels	
State	Logic
Low	0V to 0.8V
High	2.0V to 5.0V

Power Up Programming Truth Table	
PUP	Attenuator Setting
Low	Minimum Attenuation (0 dB)
High	Maximum Attenuation (31.5 dB)

Pin	Function	Description
1	RFIN	RF Input.
2	GND	RF/DC Ground Connection.
3	VCC_AMP1	Supply Voltage for Amplifier 1.
4	GND	RF/DC Ground Connection.
5	GND	RF/DC Ground Connection.
6	GND	RF/DC Ground Connection.
7	GND	RF/DC Ground Connection.
8	NC	No Internal Connection.
9	GND	RF/DC Ground Connection.
10	GND	RF/DC Ground Connection.
11	GND	RF/DC Ground Connection.
12	GND	RF/DC Ground Connection.
13	GND	RF/DC Ground Connection.
14	GND	RF/DC Ground Connection.
15	GND	RF/DC Ground Connection.
16	GND	RF/DC Ground Connection.
17	GND	RF/DC Ground Connection.
18	GND	RF/DC Ground Connection.
19	GND	RF/DC Ground Connection.
20	GND	RF/DC Ground Connection.
21	RFOUT	RF Output/Supply Voltage for Amplifier 2.
22	GND	RF/DC Ground Connection.
23	VDD	Supply Voltage for SPI and DSA Chip.
24	LE	Serial Latch Enable Input.
25	DATA	Serial Data Input.
26	CLK	Serial Clock Input.
27	PUP	Power up programming pin.
28	GND	RF/DC Ground Connection.

Evaluation Board Schematic

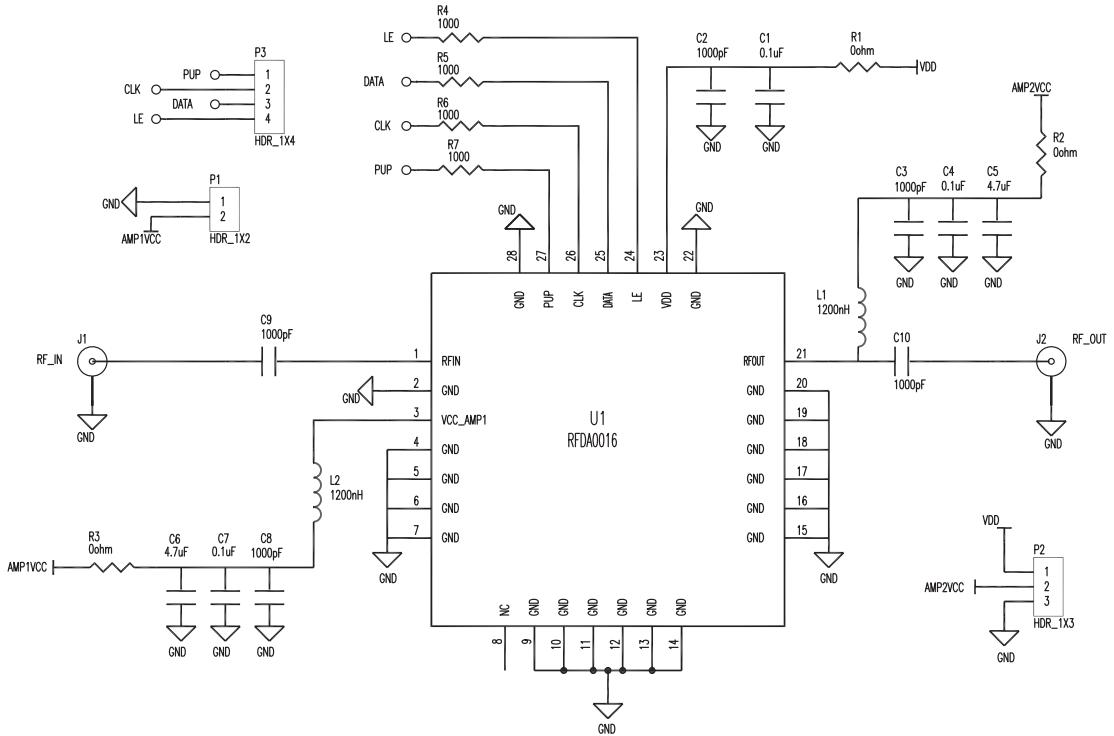

Evaluation Board Bill of Materials

Description	Reference Designator	Manufacturer	Manufacturer's P/N
PCB			RFDA0016410(A)
RFDA0016SB	U1	RFMD	RFDA0016
CONN, SMA, END LNCH, FLT, 0.062"	J1, J2	Emerson	142-0701-821
CONN, HDR, ST, PLRZD, 2-PIN, 0.100"	P1	ITW Pancon	MPSS100-2-C
CONN, HDR, ST, PLRZD, 3-PIN, 0.100"	P2	ITW Pancon	MPSS100-3-C
CONN, HDR, ST, PLRZD, 4-PIN, 0.100"	P3	ITW Pancon	MPSS100-4-C
IND, 1200nH, 5%, W/W, 1008	L1, L2	Coilcraft	1008CS-122XJLC
CAP, 1000pF, 10%, 50V, X7R, 0402	C2, C3, C8, C9, C10	Murata	GRM155R71H102KA01E
CAP, 0.1uF, 10%, 16V, X7R, 0603	C1	Murata	GRM188R71C104KA01D
CAP, 0.1uF, 10%, 16V, X7R, 0402	C4, C7	Murata	GRM155R71C104KA88D
CAP, 4.7uF, 10%, 16V, X7R, 0805	C5, C6	Murata	GRM21BR71C475KA73L
RES, 1K, 5%, 1/16W, 0402	R4, R5, R6, R7	Panasonic	ERJ-2GEJ102
RES, 0 OHM, 0402	R1, R2, R3	Kamaya, Inc	RMC1/16SJPTH

Package Drawing
MCM 28-Pin, 6.0mmx6.0mm

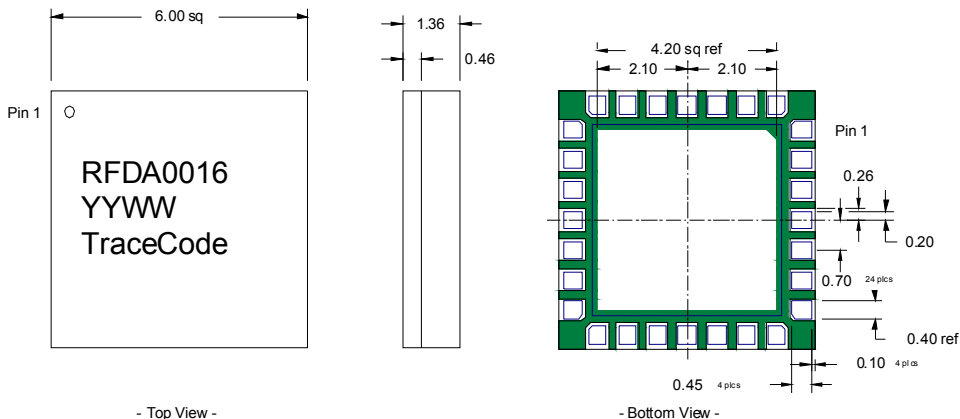

YYWW = Date Code, where YY=year, WW=week
Trace Code to be assigned by assembly SubCon

Ordering Information

Ordering Code	Description
RFDA0016SQ	Sample bag with 25 pieces
RFDA0016SR	7" Reel with 100 pieces
RFDA0016TR7	7" Reel with 750 pieces
RFDA0016TR13	13" Reel with 2500 pieces
RFDA0016PCK-410	50MHz to 850MHz PCBA with 5-piece sample bag