

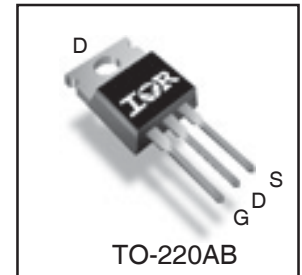
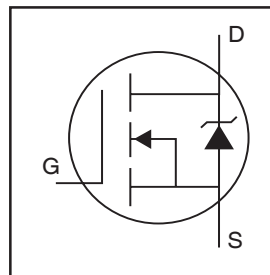
**PDP SWITCH**

**IRFB4228PbF**

**Features**

- Advanced Process Technology
- Key Parameters Optimized for PDP Sustain, Energy Recovery and Pass Switch Applications
- Low  $E_{PULSE}$  Rating to Reduce Power Dissipation in PDP Sustain, Energy Recovery and Pass Switch Applications
- Low  $Q_G$  for Fast Response
- High Repetitive Peak Current Capability for Reliable Operation
- Short Fall & Rise Times for Fast Switching
- 175°C Operating Junction Temperature for Improved Ruggedness
- Repetitive Avalanche Capability for Robustness and Reliability

Key Parameters		
$V_{DS\ min}$	150	V
$V_{DS\ (Avalanche)\ typ.}$	180	V
$R_{DS(ON)\ typ.\ @\ 10V}$	12	mΩ
$I_{RP\ max\ @\ T_C=100^\circ C}$	170	A
$T_J\ max$	175	°C



G	D	S
Gate	Drain	Source

**Description**

This HEXFET® Power MOSFET is specifically designed for Sustain; Energy Recovery & Pass switch applications in Plasma Display Panels. This MOSFET utilizes the latest processing techniques to achieve low on-resistance per silicon area and low  $E_{PULSE}$  rating. Additional features of this MOSFET are 175°C operating junction temperature and high repetitive peak current capability. These features combine to make this MOSFET a highly efficient, robust and reliable device for PDP driving applications.

**Absolute Maximum Ratings**

	Parameter	Max.	Units
$V_{GS}$	Gate-to-Source Voltage	±30	V
$I_D @ T_C = 25^\circ C$	Continuous Drain Current, $V_{GS} @ 10V$	83	A
$I_D @ T_C = 100^\circ C$	Continuous Drain Current, $V_{GS} @ 10V$	59	
$I_{DM}$	Pulsed Drain Current ①	330	
$I_{RP} @ T_C = 100^\circ C$	Repetitive Peak Current ⑤	170	
$P_D @ T_C = 25^\circ C$	Power Dissipation	330	W
$P_D @ T_C = 100^\circ C$	Power Dissipation	170	
	Linear Derating Factor	2.2	W/°C
$T_J$ $T_{STG}$	Operating Junction and Storage Temperature Range	-40 to + 175	°C
	Soldering Temperature for 10 seconds	300	
	Mounting Torque, 6-32 or M3 Screw	10lb·in (1.1N·m)	

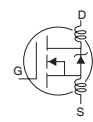
**Thermal Resistance**

	Parameter	Typ.	Max.	Units
$R_{\theta JC}$	Junction-to-Case ④	—	0.45	°C/W
$R_{\theta CS}$	Case-to-Sink, Flat, Greased Surface	0.50	—	
$R_{\theta JA}$	Junction-to-Ambient ④	—	62	

Notes ① through ⑤ are on page 8

## Electrical Characteristics @ $T_J = 25^\circ\text{C}$ (unless otherwise specified)

	Parameter	Min.	Typ.	Max.	Units	Conditions
$BV_{DSS}$	Drain-to-Source Breakdown Voltage	150	—	—	V	$V_{GS} = 0V, I_D = 250\mu A$
$\Delta BV_{DSS}/\Delta T_J$	Breakdown Voltage Temp. Coefficient	—	150	—	mV/°C	Reference to $25^\circ\text{C}, I_D = 1mA$
$R_{DS(on)}$	Static Drain-to-Source On-Resistance	—	12	15	mΩ	$V_{GS} = 10V, I_D = 33A$ ③
$V_{GS(th)}$	Gate Threshold Voltage	3.0	—	5.0	V	$V_{DS} = V_{GS}, I_D = 250\mu A$
$\Delta V_{GS(th)}/\Delta T_J$	Gate Threshold Voltage Coefficient	—	-14	—	mV/°C	
$I_{DSS}$	Drain-to-Source Leakage Current	—	—	20	μA	$V_{DS} = 150V, V_{GS} = 0V$
		—	—	1.0	mA	$V_{DS} = 150V, V_{GS} = 0V, T_J = 125^\circ\text{C}$
$I_{GSS}$	Gate-to-Source Forward Leakage	—	—	100	nA	$V_{GS} = 20V$
	Gate-to-Source Reverse Leakage	—	—	-100	nA	$V_{GS} = -20V$
$g_{fs}$	Forward Transconductance	170	—	—	S	$V_{DS} = 25V, I_D = 50A$
$Q_g$	Total Gate Charge	—	71	107	nC	$V_{DD} = 75V, I_D = 50A, V_{GS} = 10V$ ③
$Q_{gd}$	Gate-to-Drain Charge	—	21	—	nC	
$t_{d(on)}$	Turn-On Delay Time	—	18	—	ns	$V_{DD} = 75V, V_{GS} = 10V$ ③ $I_D = 50A$ $R_G = 2.5\Omega$ See Fig. 22
$t_r$	Rise Time	—	59	—		
$t_{d(off)}$	Turn-Off Delay Time	—	24	—		
$t_f$	Fall Time	—	33	—		
$t_{st}$	Shoot Through Blocking Time	100	—	—	ns	$V_{DD} = 120V, V_{GS} = 15V, R_G = 5.1\Omega$
$E_{PULSE}$	Energy per Pulse	—	58	—	μJ	$L = 220nH, C = 0.3\mu F, V_{GS} = 15V$ $V_{DS} = 120V, R_G = 5.1\Omega, T_J = 25^\circ\text{C}$
		—	110	—		$L = 220nH, C = 0.3\mu F, V_{GS} = 15V$ $V_{DS} = 120V, R_G = 5.1\Omega, T_J = 100^\circ\text{C}$
$C_{iss}$	Input Capacitance	—	4530	—	pF	$V_{GS} = 0V$
$C_{oss}$	Output Capacitance	—	550	—		$V_{DS} = 25V$
$C_{rss}$	Reverse Transfer Capacitance	—	100	—		$f = 1.0MHz$
$C_{oss\ eff.}$	Effective Output Capacitance	—	480	—		$V_{GS} = 0V, V_{DS} = 0V\ to\ 120V$
$L_D$	Internal Drain Inductance	—	4.5	—	nH	Between lead, 6mm (0.25in.) from package and center of die contact
$L_S$	Internal Source Inductance	—	7.5	—		

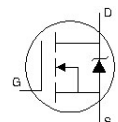


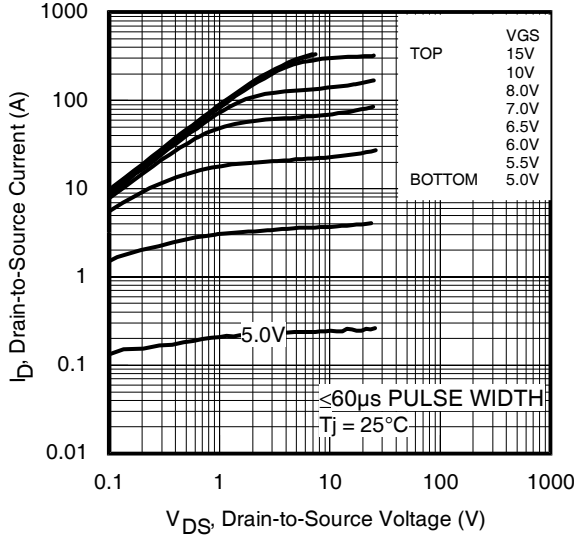
## Avalanche Characteristics

	Parameter	Typ.	Max.	Units
$E_{AS}$	Single Pulse Avalanche Energy ②	—	120	mJ
$E_{AR}$	Repetitive Avalanche Energy ①	—	33	mJ
$V_{DS(Avalanche)}$	Repetitive Avalanche Voltage ①	180	—	V
$I_{AS}$	Avalanche Current ②	—	50	A

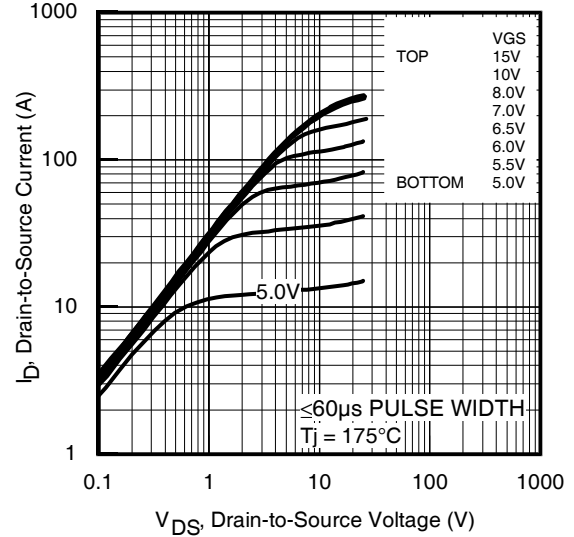
## Diode Characteristics

	Parameter	Min.	Typ.	Max.	Units	Conditions
$I_S @ T_C = 25^\circ\text{C}$	Continuous Source Current (Body Diode)	—	—	83	A	MOSFET symbol showing the integral reverse p-n junction diode.
$I_{SM}$	Pulsed Source Current (Body Diode) ①	—	—	330		
$V_{SD}$	Diode Forward Voltage	—	—	1.3	V	$T_J = 25^\circ\text{C}, I_S = 50A, V_{GS} = 0V$ ③
$t_{rr}$	Reverse Recovery Time	—	76	110	ns	$T_J = 25^\circ\text{C}, I_F = 50A, V_{DD} = 50V$
$Q_{rr}$	Reverse Recovery Charge	—	230	350	nC	$di/dt = 100A/\mu s$ ③

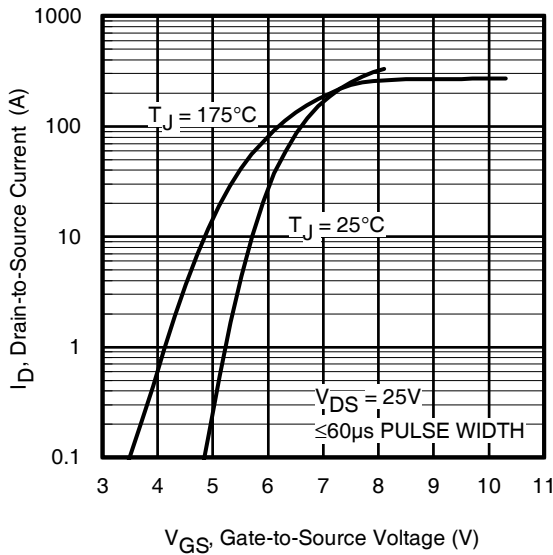




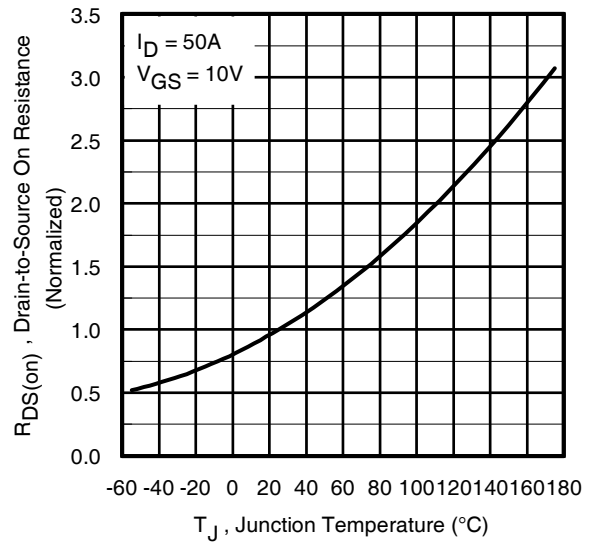
**Fig 1.** Typical Output Characteristics



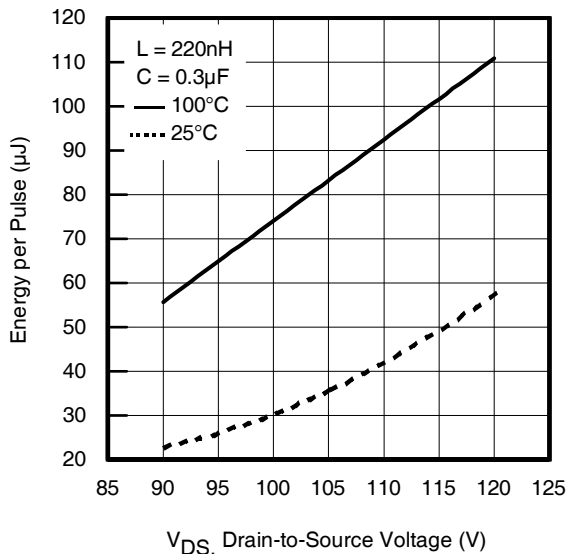
**Fig 2.** Typical Output Characteristics



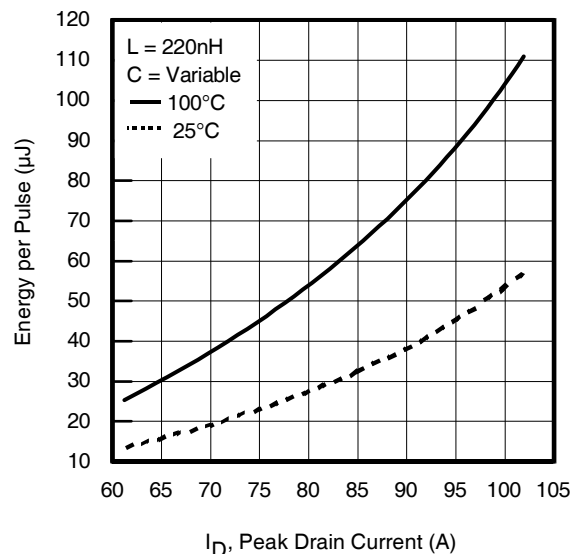
**Fig 3.** Typical Transfer Characteristics



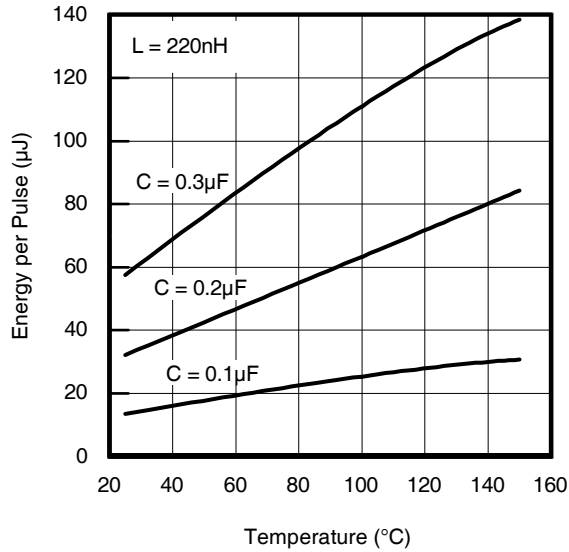
**Fig 4.** Normalized On-Resistance vs. Temperature



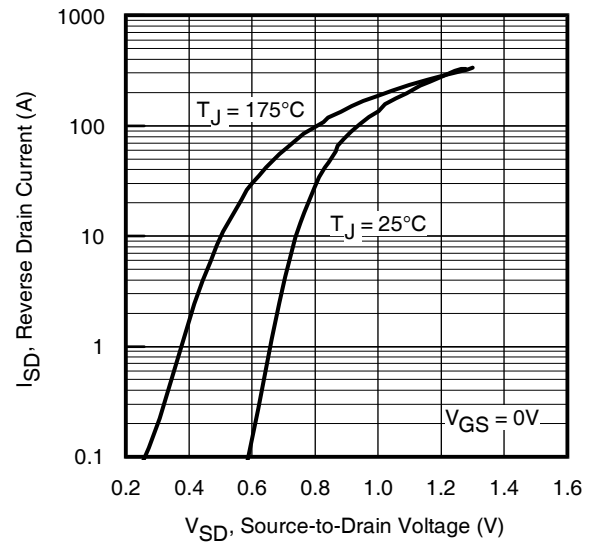
**Fig 5.** Typical  $E_{PULSE}$  vs. Drain-to-Source Voltage



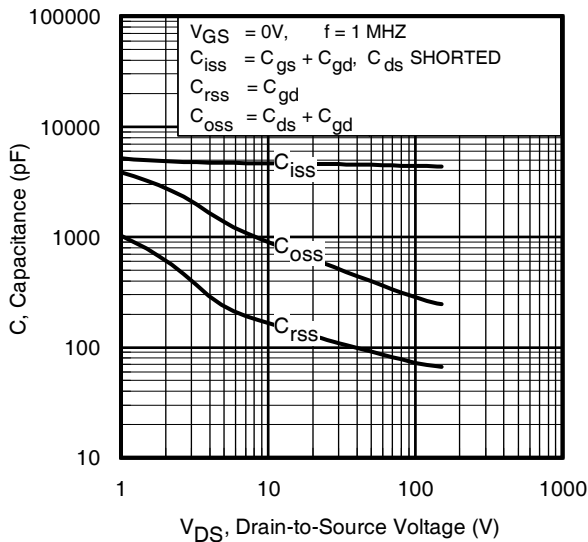
**Fig 6.** Typical  $E_{PULSE}$  vs. Drain Current



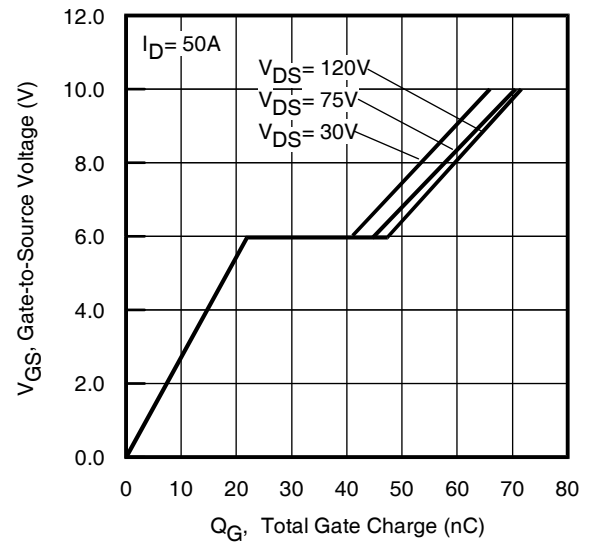
**Fig 7.** Typical  $E_{PULSE}$  vs. Temperature



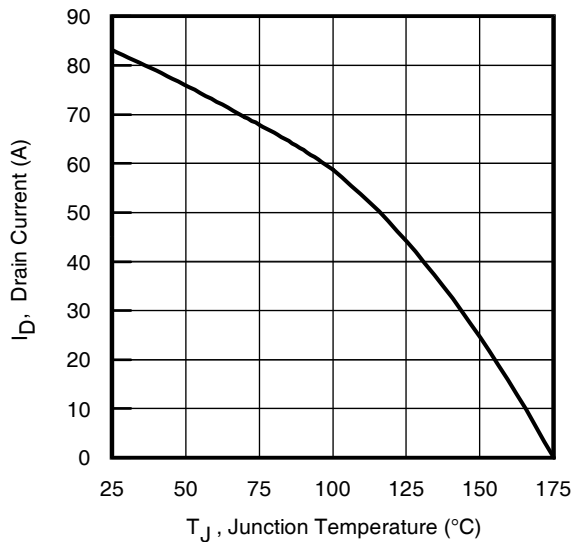
**Fig 8.** Typical Source-Drain Diode Forward Voltage



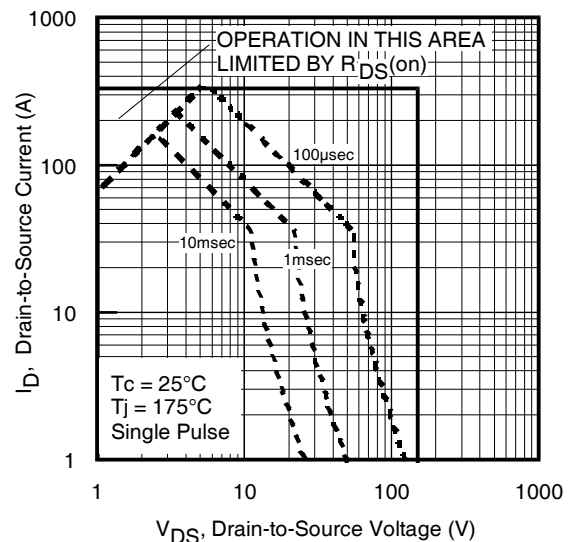
**Fig 9.** Typical Capacitance vs. Drain-to-Source Voltage



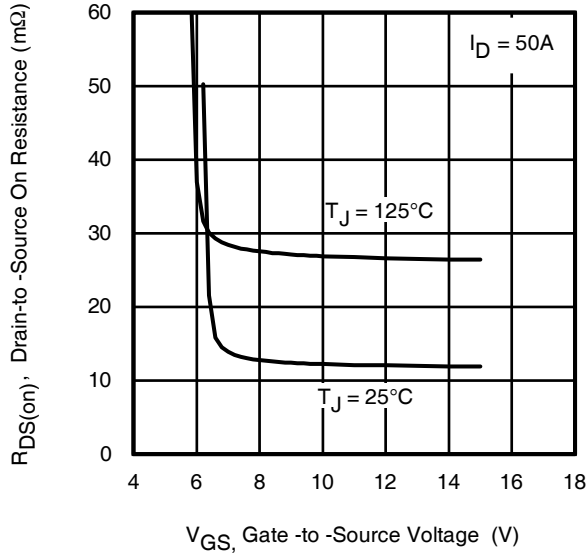
**Fig 10.** Typical Gate Charge vs. Gate-to-Source Voltage



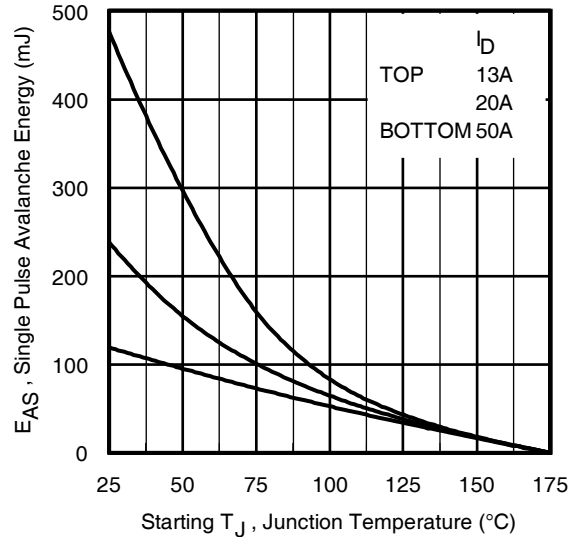
**Fig 11.** Maximum Drain Current vs. Case Temperature



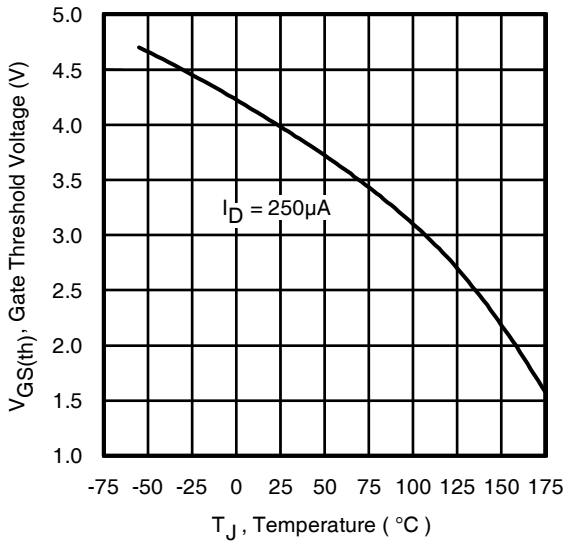
**Fig 12.** Maximum Safe Operating Area



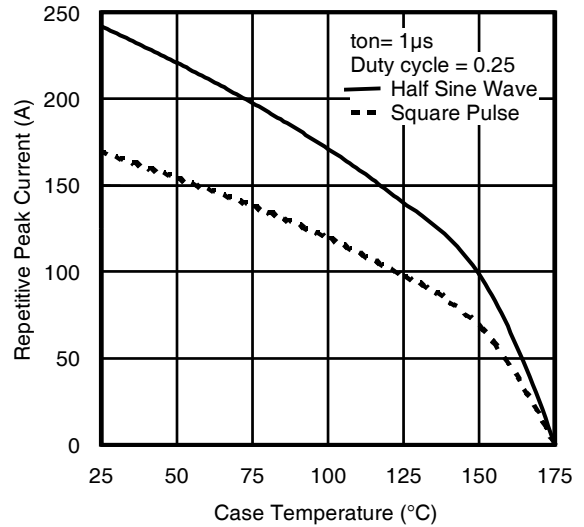
**Fig 13.** On-Resistance vs. Gate Voltage



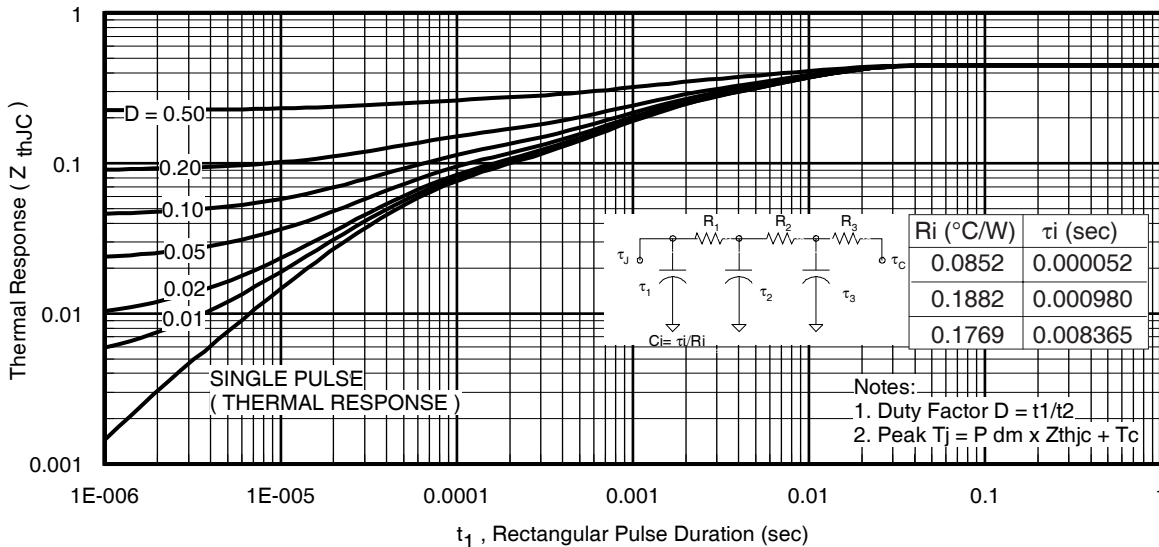
**Fig 14.** Maximum Avalanche Energy vs. Temperature



**Fig 15.** Threshold Voltage vs. Temperature



**Fig 16.** Typical Repetitive peak Current vs. Case temperature



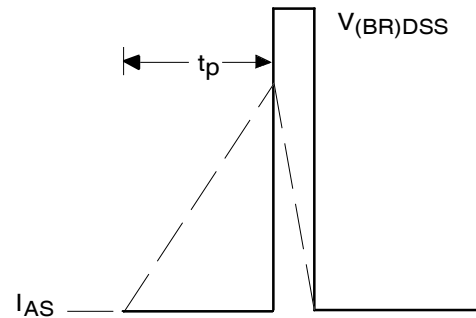
**Fig 17.** Maximum Effective Transient Thermal Impedance, Junction-to-Case



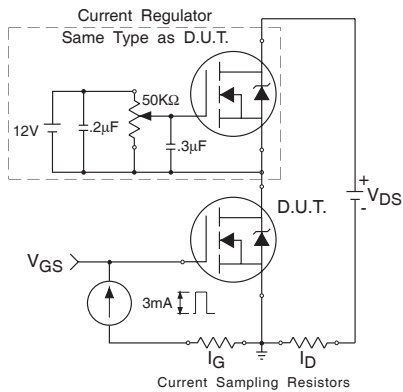
**Fig 18.** Diode Reverse Recovery Test Circuit for HEXFET® Power MOSFETs



**Fig 19a.** Unclamped Inductive Test Circuit



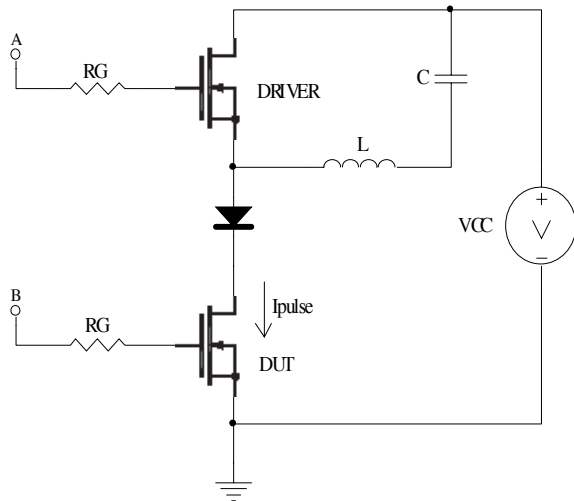
**Fig 19b.** Unclamped Inductive Waveforms



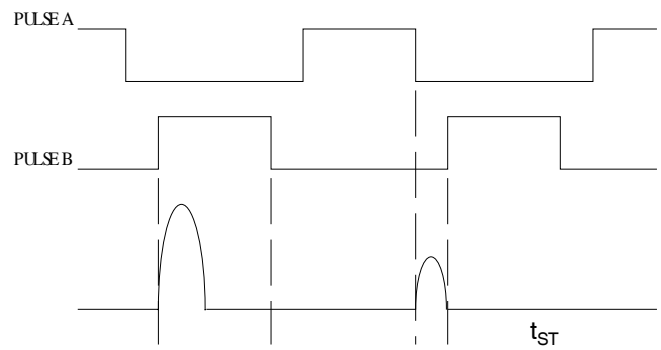
**Fig 20a.** Gate Charge Test Circuit



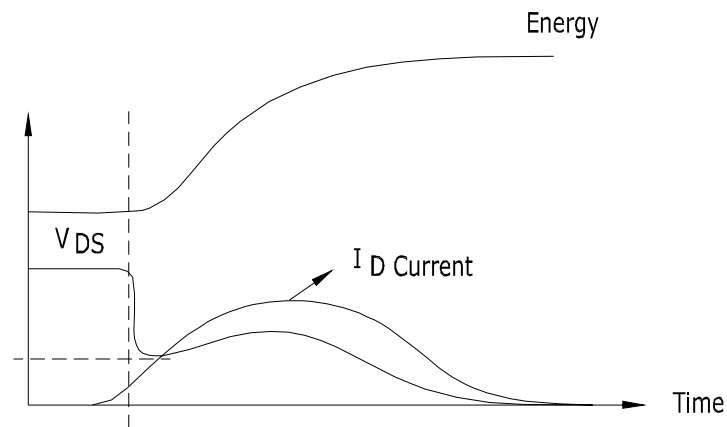
**Fig 20b.** Gate Charge Waveform



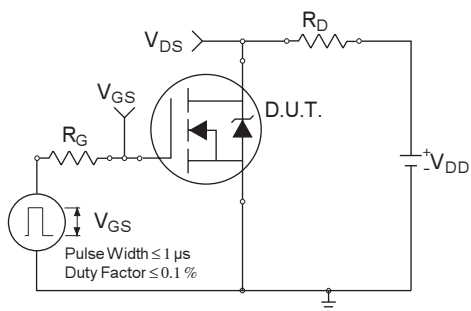
**Fig 21a.**  $t_{st}$  and  $E_{PULSE}$  Test Circuit



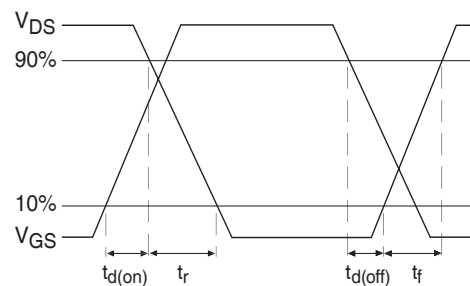
**Fig 21b.**  $t_{st}$  Test Waveforms



**Fig 21c.**  $E_{PULSE}$  Test Waveforms



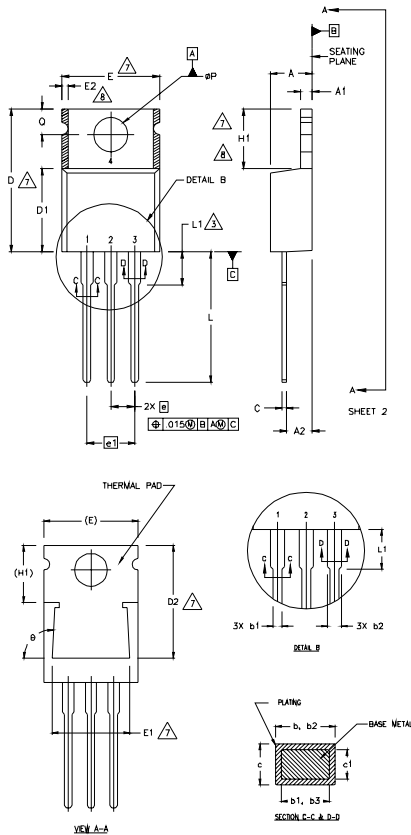
**Fig 22a.** Switching Time Test Circuit



**Fig 22b.** Switching Time Waveforms

# IRFB4228PbF

## TO-220AB Package Outline (Dimensions are shown in millimeters (inches))



**NOTES:**

- 1 DIMENSIONING AND TOLERANCING PER ASME Y14.5 M- 1994.
- 2 DIMENSIONS ARE SHOWN IN INCHES (MILLIMETERS).
- 3 LEAD DIMENSION AND FINISH UNCONTROLLED IN L1.
- 4 DIMENSION D & E DO NOT INCLUDE MOLD FLASH. MOLD FLASH SHALL NOT EXCEED .005" (0.127) PER SIDE. THESE DIMENSIONS ARE MEASURED AT THE OUTERMOST EXTREMES OF THE PLASTIC BODY.
- 5 DIMENSION b1 & c1 APPLY TO BASE METAL ONLY.
- 6 CONTROLLING DIMENSION : INCHES.
- 7 THERMAL PAD CONTOUR OPTIONAL WITHIN DIMENSIONS E,H1,D2 & E1
- 8 DIMENSION E2 X H1 DEFINE A ZONE WHERE STAMPING AND SINGULATION IRREGULARITIES ARE ALLOWED.

**LEAD ASSIGNMENTS**

**HEXFEET**

- 1- GATE
- 2- DRAIN
- 3- SOURCE

**ISBTA COPACs**

- 1- GATE
- 2- COLLECTOR
- 3- EMITTER

**DIODES**

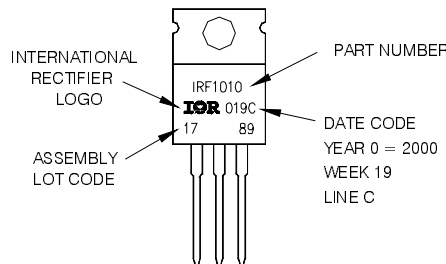
- 1.- ANODE/OPEN
- 2.- CATHODE
- 3.- ANODE

SYMBOL	DIMENSIONS				NOTES
	MILLIMETERS		INCHES		
	MIN.	MAX.	MIN.	MAX.	
A	3.56	4.82	.140	.190	
A1	0.51	1.40	.020	.055	
A2	2.04	2.92	.080	.115	
b	0.38	1.01	.015	.040	
b1	0.38	0.96	.015	.038	5
b2	1.15	1.77	.045	.070	
b3	1.15	1.73	.045	.068	
c	0.36	0.61	.014	.024	
c1	0.36	0.56	.014	.022	5
D	14.22	16.51	.560	.650	4
D1	8.38	9.02	.330	.355	
D2	12.19	12.88	.480	.507	7
E	9.66	10.66	.380	.420	4,7
E1	8.38	8.89	.330	.350	7
e	2.54 BSC		.100 BSC		
e1	5.08		.200 BSC		
H1	5.85	6.55	.230	.270	7,8
L	12.70	14.73	.500	.580	
L1	-	6.35	-	.250	
ØP	3.54	4.08	.139	.161	
Ø	2.54	3.42	.100	.135	
Ø	90°-93°		90°-93°		

## TO-220AB Part Marking Information

EXAMPLE: THIS IS AN IRF1010  
 LOT CODE 1789  
 ASSEMBLED ON WW 19, 2000  
 IN THE ASSEMBLY LINE 'C'

Note: 'P' in assembly line position indicates 'Lead - Free'



### TO-220AB packages are not recommended for Surface Mount Application.

**Notes:**

- ① Repetitive rating; pulse width limited by max. junction temperature.
- ② Starting  $T_J = 25^\circ\text{C}$ ,  $L = 0.096\text{mH}$ ,  $R_G = 25\Omega$ ,  $I_{AS} = 50\text{A}$ .
- ③ Pulse width  $\leq 400\mu\text{s}$ ; duty cycle  $\leq 2\%$ .
- ④  $R_\theta$  is measured at  $T_J$  of approximately  $90^\circ\text{C}$ .
- ⑤ Half sine wave with duty cycle = 0.25,  $t_{on} = 1\mu\text{sec}$ .

**Note:** For the most current drawing please refer to IR website at: <http://www.irf.com/package/>

Data and specifications subject to change without notice.  
 This product has been designed and qualified for the Industrial market.  
 Qualification Standards can be found on IR's Web site.