

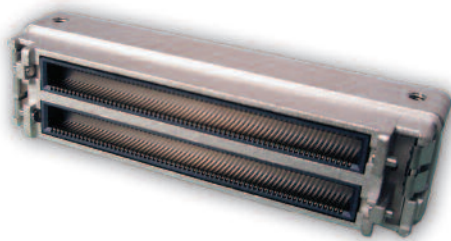

# ITT

## Interconnect Solutions

### Cannon DL Series ZIF Connectors

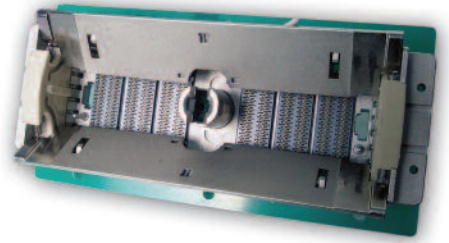
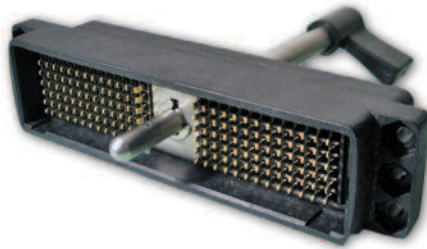

*Engineered for life*

# Cannon, VEAM, BIW

## A Historical Achievement of Technology Leadership

### Defining and Championing Innovation

Showcasing a portfolio of creativity, ITT's "Engineered For Life" execution embraces products which have become ubiquitous in a broad collection of markets including: Military/Aerospace, Civil Aircraft, Industrial Instrumentation, Medical, Oil & Gas, Energy, Transportation, Telecom/Handset, Computer, Consumer, and Automotive.

ITT's rich interconnect history embraces contributions to both technological breakthroughs and social movements. With one of the industry's broadest product offerings, ITT's interconnect products have supported:

- Every Free World space mission, bringing the universe to our doorstep.
- Motion picture, radio, and television equipment, serving laughter and entertainment to millions.
- Commercial and military communications systems, linking the voices of the world.
- Computerized tools, reshaping the information highway.
- Aircraft, rapid transit, and automobiles, mobilizing our expanding society.
- Oil and natural gas production, powering the world's economies.
- Agricultural equipment, attacking the roots of world hunger.

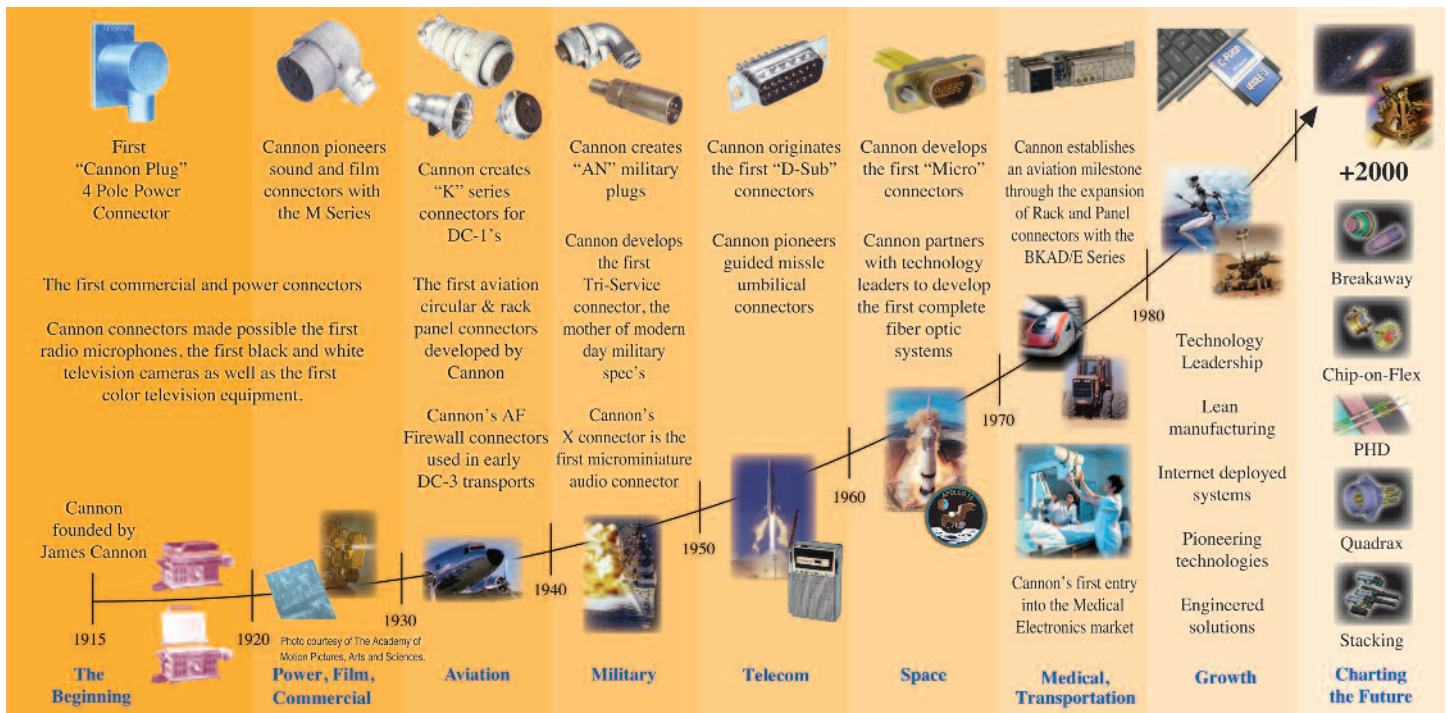

# ITT Interconnect Solutions

ITT Interconnect Solutions is a division of the multi-national ITT Corporation, a \$9 billion dollar global enterprise representing the brands Cannon, VEAM, and BIW. Our connector portfolio remains the most extensive in the industry offering the most reliable and cost effective range of interconnect solutions. These innovations have enabled ITT to provide products and technologies to such markets as:

- Automotive
- Computer/Consumer
- Industrial/Instrumentation
- Military/Aerospace
- Oil Fields
- Telecom/Handset
- Transportation

When you specify a Cannon, VEAM or BIW connector, you can rely on a product designed, developed, and manufactured to the highest quality and reliability standards. This tradition of excellence is based on ITT's corporate culture of operating its businesses under the principles of Six Sigma. At ITT, Six Sigma is not just a quality philosophy but a complete corporate culture that drives the entire business. Our Value Based Management and Value Based Product Development systems are two cornerstones that allow for the development of both leadership and product engineering principles, ensuring the correct industry leading products are developed to the accepted market driven lead times. These principles have allowed ITT to become the market leader in all of our business portfolios.

## Six Sigma Manufacturing

ITT operates manufacturing facilities in the United States, Germany, Italy, Mexico, China, Japan and the UK, all of which have particular product area strengths allowing ITT to offer a truly global footprint to our customers. Our facilities are world class and accommodate full vertical integration utilizing the latest manufacturing technologies including: automated and robotic machining centers, Super Market manufacturing cells, Kanban pull systems, and automated electrical, mechanical, and optical test and inspection equipment. The combination of our manufacturing strength

and our advanced manufacturing facilities allows ITT to offer products at market driven prices. Our capabilities, especially in robotics, computerized precision tooling, Kaizen Project Management, Six Sigma tools, and testing, give ITT the most optimized global manufacturing footprint in the interconnect industry.

## The Custom Difference

As the industry leader in harsh environment interconnect applications, ITT's world class engineering teams will work directly with our customers to design and develop cost effective solutions for their applications. In many cases we may modify one of our standard designs to ensure a highly reliable solution where timing is critical. Yet, in those cases where a complete custom interconnect solution is required, ITT will work with our customer's Engineers to design an interconnect solution which will be cost effective yet highly reliable. As professional consultants, our Engineering teams will provide a thorough systems and mechanical analysis of any proposed solution. These analyses provide our customers with sophisticated electrical signal and mechanical characterizations to determine the best solution for their application.

## RoHS Compliance Information

ITT has implemented a strict parts control plan for all ITT electronics plants worldwide that allows the Cannon, VEAM, and BIW connector product portfolios to meet the requirements of European Union Directive 2002/95/EC better known as the Reduction of Hazardous Substances initiative. As appropriate, specific Cannon, VEAM, and BIW products may be ordered with an R prefix number which insures our customers will receive RoHS compliant parts for their commercial electronics applications and equipment. Since most RoHS hazardous substances center around specific metal plating and lead solder coatings, ITT's products for RoHS compliance are available in the following plating finishes: black zinc electroless nickel, stainless steel, Anodize over aluminum and Gold plating. It should be noted that gold plating would be recommended as the replacement for tin-lead solder when ordering board mount connec-



## DL



- Plastic Body
- 60, 96, 156, or 260 Contact Cavities
- Single Hand Actuation
- Crimp or Square Post Contacts

Introduction . . . . . 10  
 Product Specifications . . . . . 11  
 How to Order . . . . . 12  
 Layout Information. . . . . 13-16

## DLD Drawer

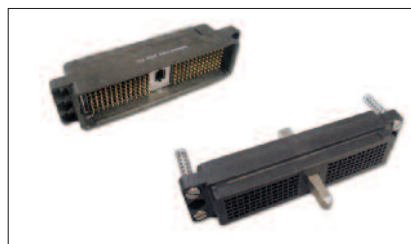

- Drawer Style
- Plastic Body
- 96 or 156 Contact Cavities
- Sliding Actuation
- Crimp or Square Post Contacts

Introduction . . . . . 17  
 Product Specification. . . . . 17  
 How to Order . . . . . 18  
 Layout Information. . . . . 19-20  
 Drawer Assembly Dimensions . . . . . 72

## DLM



- Metal Body
- EMI/RFI Shielding
- 60, 96, 156, 260 or 360 Contact Cavities
- Single Hand Actuation
- Crimp, Square Post or PC/RC Contacts

Introduction . . . . . 21  
 Product Specifications . . . . . 22  
 How to Order . . . . . 23  
 Layout Information. . . . . 24-28

## DL4

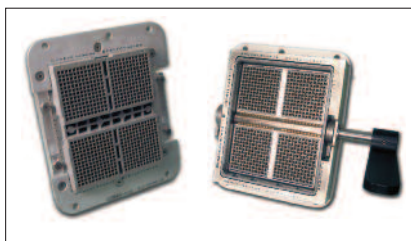

- Panel Mount
- 624, 1248, or 2496 Contact Cavities
- Lever Actuation
- Crimp or Square Post Contacts

Introduction . . . . . 29  
 Product Specifications . . . . . 30  
 How to Order . . . . . 31  
 Layout Information. . . . . 32-33

## DLP

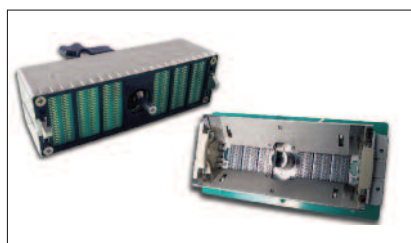

- Metal Body
- EMI/RFI Shielding
- Modular Landed Contact System  
 (DLP-272- 34 Contacts/Module  
 DLP-408 - 68 Contacts/Module)
- Single Hand Actuation

Introduction . . . . . 34  
 Product Specifications . . . . . 34  
 How to Order . . . . . 35  
 Layout Information. . . . . 36-37



**QLC**



- Metal Body
- EMI / RFI Shielding
- 260 Contacts
- Small form factor. For portable equipment

Introduction . . . . . 38  
 Product Specifications . . . . . 38  
 Layout Information. . . . . 39

**Accessories**



- Cannon offers a large selection of accessories to meet a variety of application requirements
- Allows customization using standard components

Introduction . . . . . 40  
 Selection Guide . . . . . 40  
 Junction Shells, Plastic . . . . . 41-42  
 Backshells, Metal . . . . . 43  
 Actuating Handles . . . . . 44  
 Protective Covering. . . . . 44-45  
 Polarizing Posts . . . . . 46  
 Shells (EMI/RFI) . . . . . 47

**Contacts**



- Crimp and Buss contacts are available loose or reeled
- Accommodates wire sizes #42-#18AWG
- Customer installed. Field installable/removable

Introduction . . . . . 48  
 Buss Contacts . . . . . 49  
 Crimp Contacts-Loose / Reeled . . . . . 50







**Tools and Assembly**

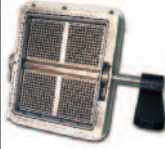

- Cannon offers hand crimp tooling for low volume applications
- Contact extraction tools
- Automatic tooling can be leased for large volume applications

Introduction . . . . . 51  
 Hand Crimp Tools . . . . . 51  
 Extraction Tools . . . . . 52  
 Assembly Instructions. . . . . 53-55  
 Lease Automatic Tooling. . . . . 56-57

PCB Hole Pattern and Pad Layout. . . . . 58-65  
 Panel Cutouts. . . . . 66-68  
 Contact Cavity Arrangements. . . . . 69-71

|   | DL  | DLD   | DLM   | DL4   | DLP 136 - 272   | DLP 408   | QLC   |
|---|---|---|---|---|---|---|---|
|   |  |  |  |  |  |  |  |
| <b>Type</b>                               | Plug & Receptacle   | Plug & Receptacle   | Plug & Receptacle   | Plug & Receptacle   | Plug & Receptacle   | Plug & Receptacle   | Plug & Receptacle   |
| <b>Body</b>                               | Plastic   | Plastic   | Metal   | Metal   | Metal   | Metal   | Metal   |
| <b>Body Material</b>                      | Thermoplastic   | Thermoplastic   | Aluminum  | Aluminum  | Aluminum  | Zinc Alloy  | Zinc  |
| <b>Available Layouts</b>                  | 60; 96; 156; and 260 signal   | 96 and 156 signal   | 60; 96; 156 260 and 360 signal  | 624 and 1248 signal   | 136, 204 and 272 signal   | 408 signal  | 260 signal  |
| <b>Crimp Contacts</b>                     | yes   | yes   | yes   | yes   | -   | -   | -   |
| <b>Square Post Contacts</b>               | yes   | yes   | yes   | yes   | -   | -   | -   |
| <b>PC/RC Contacts</b>                     | -   | -   | yes   | -   | -   | -   | -   |
| <b>Pressfit Contacts</b>                  | yes (1)   | -   | yes (2)   | -   | no  | yes   | no  |
| <b>Current Rating</b>                     | 5 A max. (3)  | 5 A max. (3)  | 5 A max. (3) / 4 A max. (4)   | 5 A max. (3)  | 0,5 A max.  | 0,3 A max   | 0,5A max  |
| <b>Contact Resistance</b>                 | 15 milliohms max.   | 15 milliohms max.   | 15 milliohms max.   | 15 milliohms max.   | 30 milliohms max. (Initial)   | 30 milliohms max. (Initial)   | 100 milliohms max (includes bulk resistance)  |
|   | 20 milliohms max. (5)   | 20 milliohms max. (5)   | 20 milliohms max. (5)   | 20 milliohms max. (5)   |   |   |   |
|   |   |   | 30 milliohms max. (4)   |   |   |   |   |
| <b>Contact Material</b>                   | 20 or 50□ inches gold plated copper alloy   | 50□ inches gold plated copper alloy   | 20 or 50□ inches gold plated copper alloy   | 20 or 50□ inches gold plated copper alloy   | Gold plated copper Alloy  | Gold plated copper Alloy  | 40□ inch gold plated copper alloy   |
| <b>Operating temperature</b>              | -55°C to 105°C  | -55°C to 105°C  | -55°C to 105°C  | -55°C to 71°C   | -55°C to 85°C   | -55°C to 85°C   | -55°C to 85°C   |
| <b>RoHS compliant</b>                     | yes   | yes   | yes   | yes   | yes   | yes   | yes   |
| <b>Factory terminated</b>                 | Solder to PCB Through Hole  | Solder to PCB Through Hole  | Solder to PCB Through Hole  | Solder to PCB Through Hole  | Solder to PCB Through Hole  | Press-fit   | Solder to PCB through hole  |
| <b>Mating cycles</b>                      | 10,000 min.   | 100,000 min.  | 10,000 min.   | 20,000 min.   | 10,000 max  | 10,000 max  | 20,000 max  |
| <b>EMI/RFI shielding</b>                  | -   | -   | yes   | yes   | yes   | yes   | yes   |
| <b>Accessories</b> See Pages 40-47        |   |   |   |   |   |   |   |
| <b>Actuating handles</b>                  | yes   | -   | yes   | included  | yes   | yes   | yes   |
| <b>Protective Cover (Rubber) (6)</b>      | yes   | -   | yes   | yes   | -   | -   | -   |
| <b>Protective Cover (Plastic) (7)</b>     | yes   | -   | yes   | -   | yes   | -   | -   |
| <b>Metals Shell for EMI/RFI shielding</b> | yes (5)   | -   | -   | -   | -   | -   | -   |
| <b>Plastic Junction Shell</b>             | yes   | -   | yes   | -   | -   | -   | -   |
| <b>Cable Clamps</b>                       | yes   | -   | yes   | -   | -   | -   | -   |
| <b>Metals Backshell</b>                   | yes   | -   | yes   | -   | -   | -   | -   |
| <b>Polarizing Posts</b>                   | yes   | -   | yes   | -   | -   | -   | -   |
| <b>Page number</b>                        | 10-16   | 17-20   | 21-28   | 29-33   | 34-36   | 37  | 38-39   |

Notes:

- (1) DL5 only
- (2) DLM5 only
- (3) Crimp or Square Post Contacts
- (4) PC/RC contact
- (5) Specification for Crimp Contacts smaller than 28 AWG

## The mechanical function of the new DLP ZIF connector

A quarter turn of knob (shaft) mates all the contact at once by the function of cam and bearing.

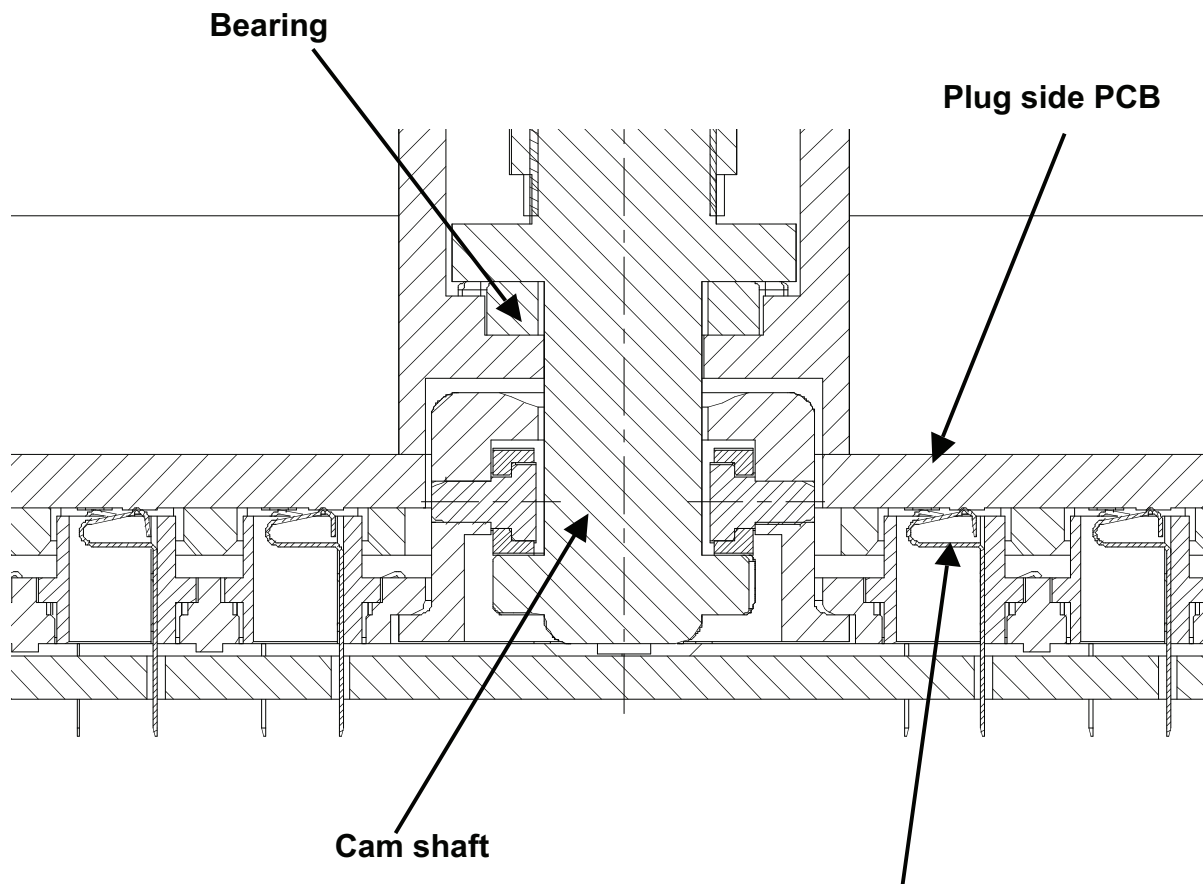

Our DLP connector uses our landed contact system. Modules of 34 or 68 contacts each are populated in to the receptacle to the customer's requirements. These contacts are positioned to land on pads that are designed into the customer supplied PCB and mounted to the plug connector housing. When mated, the contacts do not touch the pads on the plug PCB. Once the handle is rotated and locked, the shape of the receptacle contact generates a slight wipe on the plug PCB pads.

The long life and rapid mating are achieved through the use of our Zero Insertion Force design. Contact in the plug and receptacle do not touch each other while the connector halves are being engaged.

**Step 1:**

The plug is placed over the receptacle.

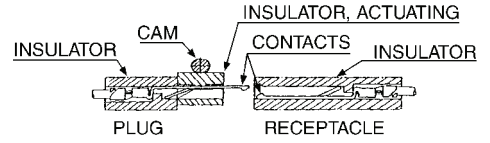
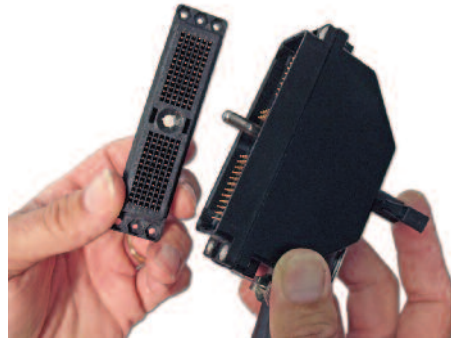

**Step 2:**

A "quarter turn" of an actuating shaft mates all contacts at once.

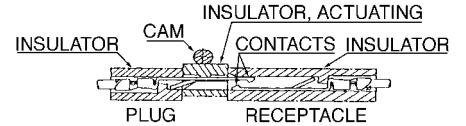
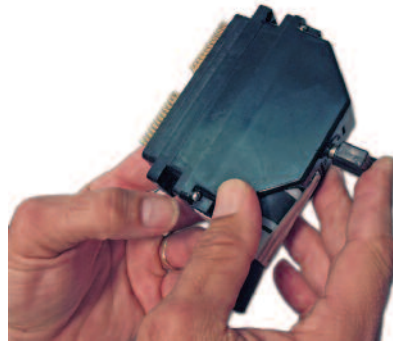

**Step 3:**

The same "quarter turn" also physically locks the connector halves together.

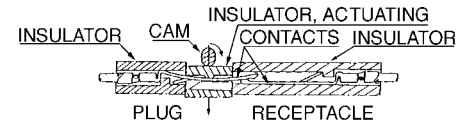

Connector engagement force is zero, and the only wear on the contacts occurs as they are pressed together and lightly wiped past each other during the camming and locking operation.





## Medical

- Ultrasound Diagnostic
- Patient Monitoring
- Hospital Equipment
- MRI (Non-Magnetic)
- Portable Equipment (Imaging)

## Commercial / Industrial Manufacturing

- Automation
- Robotics
- Electrical Controls

## Telecommunications

- Systems Interconnect
- Manufacturing Test Equipment
- Switching Systems

## Test & Instrument

- Avionics
- Automated Test Equipment
- Computer and Peripheral Equipment
- Semiconductor

## Entertainment

- Recording Studio Equipment
- Stage Lighting and Sound
- Broadcasting Equipment

## Transportation

- Locomotive Systems
- Automotive Electronics
- Aircraft Simulators

The Cannon DL Series of Zero Insertion Force (ZIF) connectors fill the need in the medical, commercial / industrial, computer, and peripheral equipment market places for low-cost, high performance, multiple-wire power and signal connectors.

DL connectors feature: a minimum rated life of 10,000 complete mating and unmating cycles with no performance loss; can be mated and unmated in less than two seconds even with as many as 2496 contacts; and they cost less (often as much as 25% less) per mated line than singular high-density rack-and-panel connectors.

*Simple. Effective. Reliable. Durable*

Combining their special design with commercial-grade materials and low cost crimp, PCB, and wrappable hermaphroditic contacts, that may be hand or machine terminated, makes the DL Series of ZIF connectors the finest low-cost-per-mated-line I/O connectors available today.



## Derating Curves

**DL1**

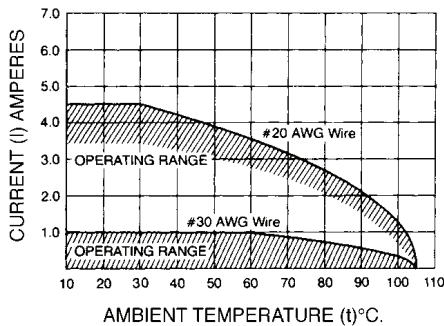

**DL2**

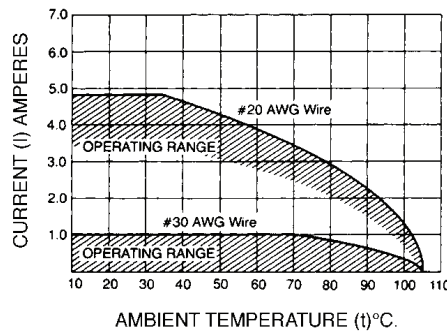

**DL3**

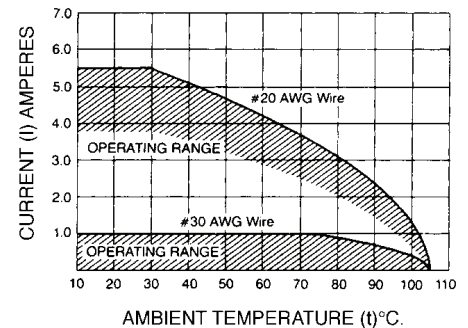

The ambient temperature curves shown represent the rated current carrying capacity of the Cannon DL1/2/3/4, electrical connectors, derated to 80% of the values recorded during the methods specified by International Electro-Technical Commission Document 48 (1975).

Current was applied to the total connector (all contacts) in one-half ampere increments and maintained at each current level until thermal stability was achieved. A thermocouple inserted into the "hottest area" of each connector then measured the connector temperature at the same time that an ambient temperature reading was taken. The difference between the two measured values is the heat rise or self-heating created solely by the current flow, and this temperature rise for the current level was deducted from the insulator material rated temperature. These values were then derated to 80% to obtain the curves shown.

## Standard Materials and Finishes

|   |   |
|---|---|
| <b>DL Housing:</b>                              | Glass Filled Thermoplastic, UL 94V-1 rated, Color: Black  |
| <b>Crimp Contacts and Square Post Contacts:</b> | - Copper alloy, 20 or 50 microinches gold over 50 microinches nickel in mated area, gold flash on balance |
| <b>Actuating Camshaft:</b>                      | Stainless steel, Passivated   |
| <b>Insulator Retainer (Plug Only)</b>           | Stainless steel, Passivated   |

## Electrical Data

|                             |   |
|-----------------------------|---|
| <b>No. of Contacts:</b>     | 60, 96, 156, and 260 signal                                     |
| <b>Wire Size:</b>           | #18 AWG through #42 AWG   |
| <b>Contact Termination:</b> | - Crimp<br>- Square Post<br>- Wrap Post<br>- Buss<br>- Pressfit |

## Mechanical Data

|                         |                          |
|-------------------------|--------------------------|
| <b>Actuation:</b>       | Single Hand              |
| <b>Coupling:</b>        | Rotating latch           |
| <b>Polarization:</b>    | Polarizing Posts         |
| <b>Contact Spacing:</b> | 2,54 (0.100) Square Grid |
| <b>Shell Styles:</b>    | Plug and Receptacle      |

## Performance Data

|   |  |
|---|--|
| <b>Current Rating:</b>                  | 5 A max - Crimp/Square Post/PCB contact<br>10 A, 20 A, 30 A, 40 A, 50 A, 60 A max - Buss contact       |
| <b>Dielectric Withstanding Voltage:</b> | 1200 VAC RMS - Crimp/Square Post Contact   |
| <b>Operating Temperature:</b>           | -55°C to 105°C (DL/DLM/DLD)  |
| <b>Insulation Resistance:</b>           | 5000 Megaohms minimum  |
| <b>Durability:</b>                      | 10,000 Cycles minimum  |
| <b>Contact Resistance:</b>              | 15 m $\Omega$ max. - Crimp/Square Post Contact<br>20 m $\Omega$ max. - Crimp #32 AWG - #30 AWG Contact |
| <b>Insulation Resistance:</b>           | 5000 M $\Omega$ min.   |
| <b>Wire Accommodation:</b>              | #42 AWG - #18 AWG  |
| <b>Contact Retention:</b>               | 8 lb (35.585 N) minimum  |

How to Order

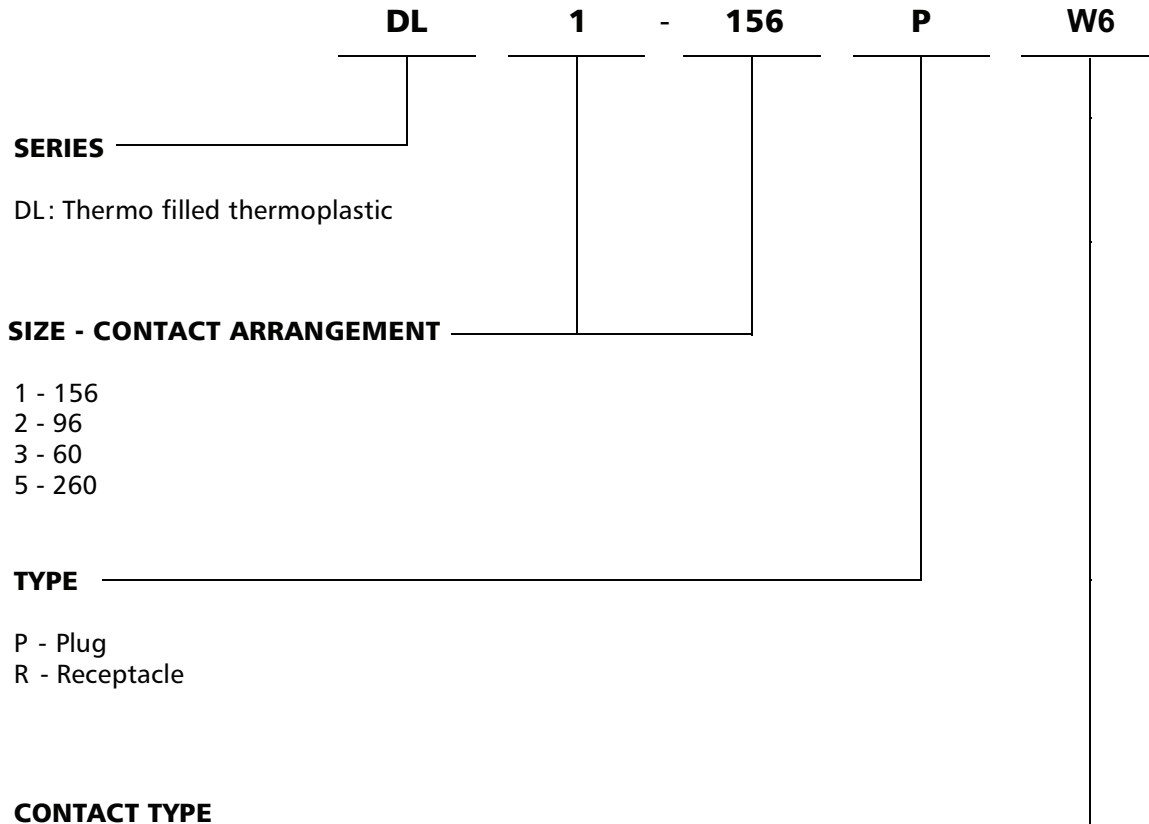

### Plug



- Order Actuating Handle Kit sold separately, see page 44.
- Crimp Contacts are to be ordered separately and to be installed by customer, see pages 48-50.
- For contact cavity arrangements see pages 69-70.
- For panel cutout and mounting hole pattern, see page 66.
- For PC hole pattern, see pages 59-61.

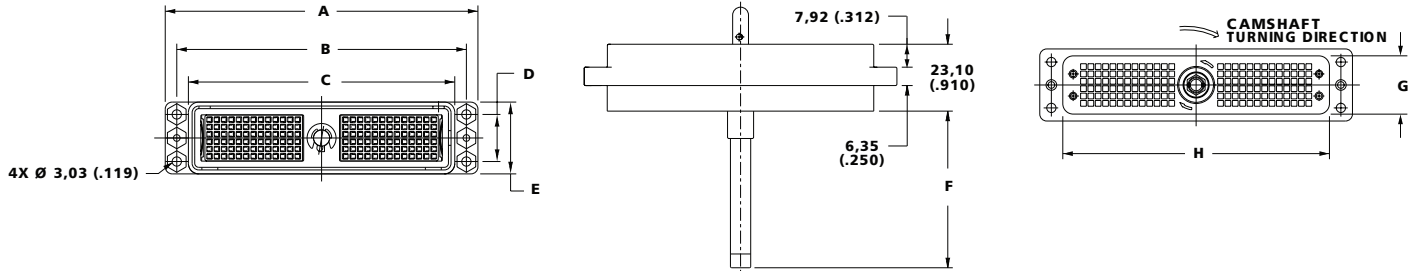

| Description     | A                 | B                 | C                | D                | E                | F                | G                | H                |
|-----------------|-------------------|-------------------|------------------|------------------|------------------|------------------|------------------|------------------|
| <b>DL3-60P</b>  | 65,80<br>(2.592)  | 57,91<br>(2.280)  | 50,55<br>(1.992) | 11,89<br>(0.466) | 24,90<br>(0.981) | 39,19<br>(1.543) | 24,90<br>(0.981) | 49,02<br>(1.931) |
| <b>DL2-96P</b>  | 65,80<br>(2.592)  | 57,91<br>(2.280)  | 50,60<br>(1.994) | 19,38<br>(.763)  | 28,12<br>(1.108) | 39,19<br>(1.543) | 24,05<br>(0.947) | 50,60<br>(1.994) |
| <b>DL1-156P</b> | 108,00<br>(4.255) | 100,03<br>(3.938) | 92,26<br>(3.631) | 16,26<br>(0.640) | 24,90<br>(0.980) | 54,81<br>(2.158) | 20,10<br>(0.792) | 92,10<br>(3.626) |
| <b>DL5-260P</b> | 108,00<br>(4.255) | 100,03<br>(3.938) | 92,26<br>(3.631) | 26,00<br>(1.024) | 35,00<br>(1.378) | 54,26<br>(2.136) | 30,30<br>(1.193) | 92,10<br>(3.626) |

### Receptacle

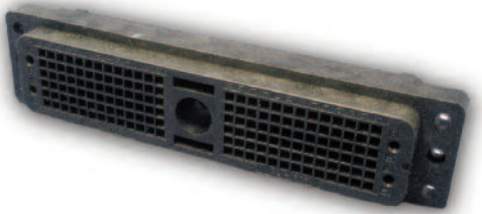

- Crimp Contacts are to be ordered separately and to be installed by customer, see pages 48-50.
- For contact cavity arrangements see pages 69-70.
- For panel cutout and mounting hole pattern, see page 66.
- For PC hole pattern, see pages 59-61.

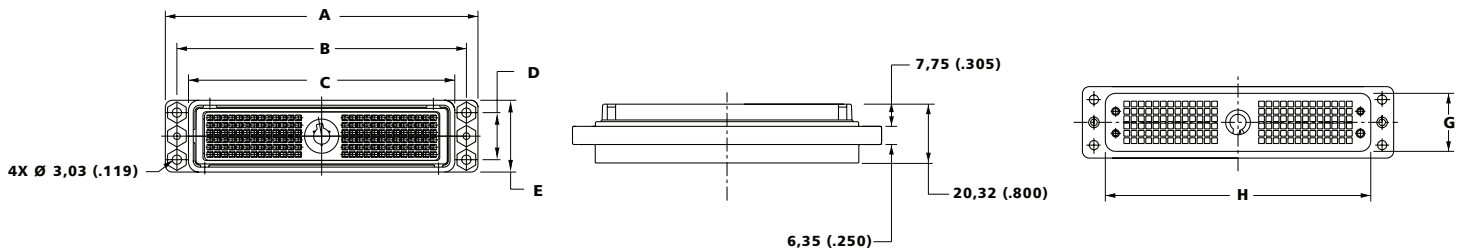

| Description     | A                 | B                 | C                | D                | E                | G                | H                |
|-----------------|-------------------|-------------------|------------------|------------------|------------------|------------------|------------------|
| <b>DL3-60R</b>  | 65,80<br>(2.592)  | 57,91<br>(2.280)  | 50,50<br>(1.988) | 11,89<br>(0.468) | 24,90<br>(0.981) | 19,18<br>(0.755) | 49,02<br>(1.931) |
| <b>DL2-96R</b>  | 65,80<br>(2.592)  | 57,91<br>(2.280)  | 50,60<br>(1.994) | 19,38<br>(.763)  | 28,12<br>(1.108) | 24,05<br>(0.947) | 50,60<br>(1.994) |
| <b>DL1-156R</b> | 108,00<br>(4.255) | 100,03<br>(3.938) | 92,10<br>(3.622) | 16,26<br>(0.640) | 24,90<br>(0.980) | 20,10<br>(0.792) | 92,10<br>(3.626) |
| <b>DL5-260R</b> | 108,00<br>(4.255) | 100,03<br>(3.938) | 92,10<br>(3.622) | 26,00<br>(1.024) | 35,00<br>(1.378) | 30,30<br>(1.193) | 92,10<br>(3.626) |

Notes:  
Crimp contacts are to be ordered separately and to be installed by customer, see pages 49-50.

Dimensions shown in mm (inch)  
Specifications and dimensions subject to change

# Cannon ZIF Connectors

## DL - Plastic Body - Square / Wrap Post Contacts

### Plug

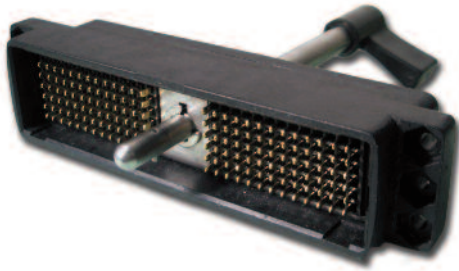

- Order Actuating Handle Kit sold separately, see page 44.
- For contact cavity arrangements see pages 69-70.
- For panel cutout and mounting hole pattern, see page 66.
- For PC hole pattern, see pages 59-61.

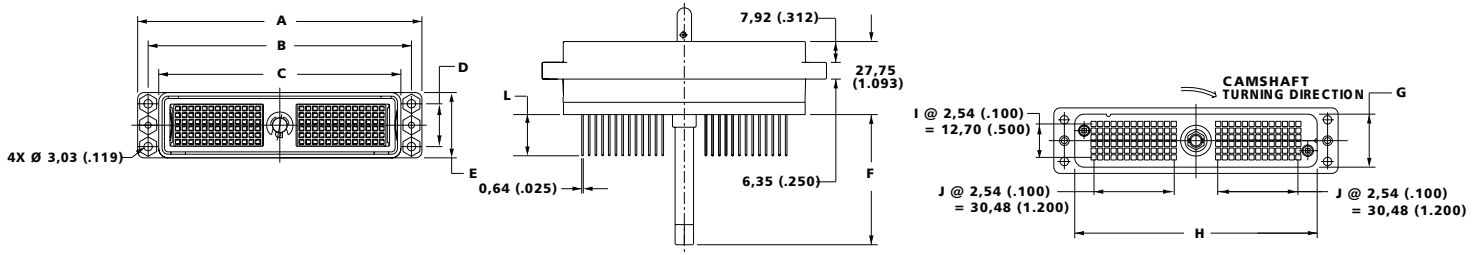

| Description                             | A                 | B                 | C                | D                | E                | F                | G                | H                | I           | J            | L               |
|---|-------------------|-------------------|------------------|------------------|------------------|------------------|------------------|------------------|-------------|--------------|-----------------|
| <b>DL3-60PW4</b><br><b>DL3-60PW4A</b>   | 65,80<br>(2.592)  | 57,91<br>(2.280)  | 50,55<br>(1.992) | 11,89<br>(.468)  | 24,90<br>(.981)  | 34,54<br>(1.360) | 19,94<br>(.785)  | 49,02<br>(1.931) | 5<br>spaces | 4<br>spaces  | 15,37<br>(.605) |
| <b>DL3-60PW6</b><br><b>DL3-60PW6A</b>   | 65,80<br>(2.592)  | 57,91<br>(2.280)  | 50,55<br>(1.992) | 11,89<br>(.468)  | 24,90<br>(.981)  | 34,54<br>(1.360) | 19,94<br>(.785)  | 49,02<br>(1.931) | 5<br>spaces | 4<br>spaces  | 7,11<br>(.280)  |
| <b>DL3-60PW9A</b>                       | 65,80<br>(2.592)  | 57,91<br>(2.280)  | 50,55<br>(1.992) | 11,89<br>(.468)  | 24,90<br>(.981)  | 34,54<br>(1.360) | 19,94<br>(.785)  | 49,02<br>(1.931) | 5<br>spaces | 4<br>spaces  | 3,18<br>(.125)  |
| <b>DL2-96PW4</b><br><b>DL2-96PW4A</b>   | 65,80<br>(2.592)  | 57,91<br>(2.280)  | 50,60<br>(1.994) | 19,38<br>(.763)  | 28,12<br>(1.108) | 34,54<br>(1.360) | 24,05<br>(.947)  | 50,60<br>(1.994) | 7<br>spaces | 6<br>spaces  | 15,37<br>(.605) |
| <b>DL2-96PW6</b><br><b>DL2-96PW6A</b>   | 65,80<br>(2.592)  | 57,91<br>(2.280)  | 50,60<br>(1.994) | 19,38<br>(.763)  | 28,12<br>(1.108) | 34,54<br>(1.360) | 24,05<br>(.947)  | 50,60<br>(1.994) | 7<br>spaces | 6<br>spaces  | 7,11<br>(.280)  |
| <b>DL2-96PW9A</b>                       | 65,80<br>(2.592)  | 57,91<br>(2.280)  | 50,60<br>(1.994) | 19,38<br>(.763)  | 28,12<br>(1.108) | 34,54<br>(1.360) | 24,05<br>(.947)  | 50,60<br>(1.994) | 7<br>spaces | 6<br>spaces  | 3,18<br>(.125)  |
| <b>DL1-156PW4</b><br><b>DL1-156PW4A</b> | 108,00<br>(4.255) | 100,03<br>(3.983) | 92,26<br>(3.631) | 16,26<br>(.640)  | 24,90<br>(.981)  | 50,16<br>(1.975) | 20,10<br>(.792)  | 92,10<br>(3.626) | 5<br>spaces | 12<br>spaces | 15,37<br>(.605) |
| <b>DL1-156PW6</b><br><b>DL1-156PW6A</b> | 108,00<br>(4.255) | 100,03<br>(3.983) | 92,26<br>(3.631) | 16,26<br>(.640)  | 24,90<br>(.981)  | 50,16<br>(1.975) | 20,10<br>(.792)  | 92,10<br>(3.626) | 5<br>spaces | 12<br>spaces | 7,11<br>(.380)  |
| <b>DL1-156PW9A</b>                      | 108,00<br>(4.255) | 100,03<br>(3.983) | 92,26<br>(3.631) | 16,26<br>(.640)  | 24,90<br>(.981)  | 50,16<br>(1.975) | 20,10<br>(.792)  | 92,10<br>(3.626) | 5<br>spaces | 12<br>spaces | 3,18<br>(.125)  |
| <b>DL5-260PW4</b><br><b>DL5-260PW4A</b> | 108,00<br>(4.255) | 100,03<br>(3.983) | 92,26<br>(3.631) | 26,00<br>(1.024) | 35,00<br>(1.378) | 49,61<br>(1.953) | 30,30<br>(1.193) | 92,10<br>(3.626) | 9<br>spaces | 12<br>spaces | 15,37<br>(.604) |
| <b>DL5-260PW6</b><br><b>DL5-260PW6A</b> | 108,00<br>(4.255) | 100,03<br>(3.983) | 92,26<br>(3.631) | 26,00<br>(1.024) | 35,00<br>(1.378) | 49,61<br>(1.953) | 30,30<br>(1.193) | 92,10<br>(3.626) | 9<br>spaces | 12<br>spaces | 7,11<br>(.280)  |
| <b>DL5-260PW9A</b>                      | 108,00<br>(4.255) | 100,03<br>(3.983) | 92,26<br>(3.631) | 26,00<br>(1.024) | 35,00<br>(1.378) | 49,61<br>(1.953) | 30,30<br>(1.193) | 92,10<br>(3.626) | 9<br>spaces | 12<br>spaces | 3,18<br>(.125)  |

Notes:

Front removable 0,64 (0.025) square posts 2,54 (0.100) Centers.  
1 space at 2,54 (0.100)

Dimensions shown in mm (inch)  
Specifications and dimensions subject to change



### Receptacle



- For contact cavity arrangements see pages 69-70.
- For panel cutout and mounting hole pattern, see page 66.
- For PC hole pattern, see pages 59-61.

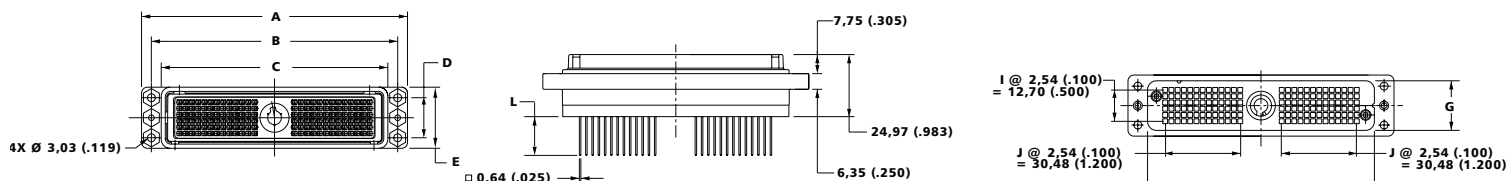

| Description                             | A                 | B                 | C                | D                | E                | G                | H                | I           | J            | L               |
|---|-------------------|-------------------|------------------|------------------|------------------|------------------|------------------|-------------|--------------|-----------------|
| <b>DL3-60RW4</b><br><b>DL3-60RW4B</b>   | 65,80<br>(2.592)  | 57,91<br>(2.280)  | 50,50<br>(1.988) | 11,89<br>(.466)  | 24,90<br>(.980)  | 19,94<br>(0.785) | 49,02<br>(1.931) | 5<br>spaces | 4<br>spaces  | 15,37<br>(.605) |
| <b>DL3-60RW6</b><br><b>DL3-60RW6B</b>   | 65,80<br>(2.592)  | 57,91<br>(2.280)  | 50,50<br>(1.988) | 11,89<br>(.466)  | 24,90<br>(1.360) | 19,94<br>(.785)  | 49,02<br>(1.931) | 5<br>spaces | 4<br>spaces  | 7,11<br>(.280)  |
| <b>DL3-60RW9B</b>                       | 65,80<br>(2.592)  | 57,91<br>(2.280)  | 50,50<br>(1.988) | 11,89<br>(0.466) | 24,90<br>(1.360) | 19,94<br>(.785)  | 49,02<br>(1.931) | 5<br>spaces | 4<br>spaces  | 3,18<br>(.125)  |
| <b>DL2-96TW4</b><br><b>DL2-96RW4B</b>   | 65,80<br>(2.592)  | 57,91<br>(2.280)  | 50,60<br>(1.994) | 19,38<br>(.763)  | 28,12<br>(1.108) | 24,05<br>(.947)  | 50,60<br>(1.994) | 7<br>spaces | 6<br>spaces  | 15,37<br>(.605) |
| <b>DL2-96RW6</b><br><b>DL2-96RW6B</b>   | 65,80<br>(2.592)  | 57,91<br>(2.280)  | 50,60<br>(1.994) | 19,38<br>(.763)  | 28,12<br>(1.108) | 24,05<br>(.947)  | 50,60<br>(1.994) | 7<br>spaces | 6<br>spaces  | 7,11<br>(.280)  |
| <b>DL2-96RW9B</b>                       | 65,80<br>(2.592)  | 57,91<br>(2.280)  | 50,60<br>(1.994) | 19,38<br>(.763)  | 28,12<br>(1.108) | 24,05<br>(.947)  | 50,60<br>(1.994) | 7<br>spaces | 6<br>spaces  | 3,18<br>(.125)  |
| <b>DL1-156RW4</b><br><b>DL1-156RW4B</b> | 108,00<br>(4.255) | 100,03<br>(3.983) | 92,00<br>(3.622) | 16,26<br>(.640)  | 24,90<br>(.980)  | 20,10<br>(.792)  | 92,10<br>(3.626) | 5<br>spaces | 12<br>spaces | 15,37<br>(.605) |
| <b>DL1-156RW6</b><br><b>DL1-156RW6B</b> | 108,00<br>(4.255) | 100,03<br>(3.983) | 92,00<br>(3.622) | 16,26<br>(.640)  | 24,90<br>(.980)  | 20,10<br>(.792)  | 92,10<br>(3.626) | 5<br>spaces | 12<br>spaces | 7,11<br>(.380)  |
| <b>DL1-156RW9B</b>                      | 108,00<br>(4.255) | 100,03<br>(3.983) | 92,00<br>(3.622) | 16,26<br>(.640)  | 24,90<br>(.980)  | 20,10<br>(.792)  | 92,10<br>(3.626) | 5<br>spaces | 12<br>spaces | 3,18<br>(.125)  |
| <b>DL5-260RW4</b><br><b>DL5-260RW4B</b> | 108,00<br>(4.255) | 100,03<br>(3.983) | 92,00<br>(3.622) | 26,00<br>(1.024) | 35,00<br>(1.378) | 30,30<br>(1.193) | 92,10<br>(3.626) | 9<br>spaces | 12<br>spaces | 15,37<br>(.604) |
| <b>DL5-260RW6</b><br><b>DL5-260RW6B</b> | 108,00<br>(4.255) | 100,03<br>(3.983) | 92,00<br>(3.622) | 26,00<br>(1.024) | 35,00<br>(1.378) | 30,30<br>(1.193) | 92,10<br>(3.626) | 9<br>spaces | 12<br>spaces | 7,11<br>(.280)  |
| <b>DL5-260RW9B</b>                      | 108,00<br>(4.255) | 100,03<br>(3.983) | 92,00<br>(3.622) | 26,00<br>(1.024) | 35,00<br>(1.378) | 30,30<br>(1.193) | 92,10<br>(3.626) | 9<br>spaces | 12<br>spaces | 3,18<br>(.125)  |

Notes:

Front removable 0,64 (0.025) square posts 2,54 (0.100) Centers.

1 space at 2,54 (0.100)

## Receptacle only



- For contact cavity arrangements see page 70.
- For panel cutout and mounting hole pattern, see page 66.
- For PC hole pattern, see page 62.

| Part Number | Nomenclature |
|-------------|--------------|
| 11987-0008  | DL5-260R-F   |

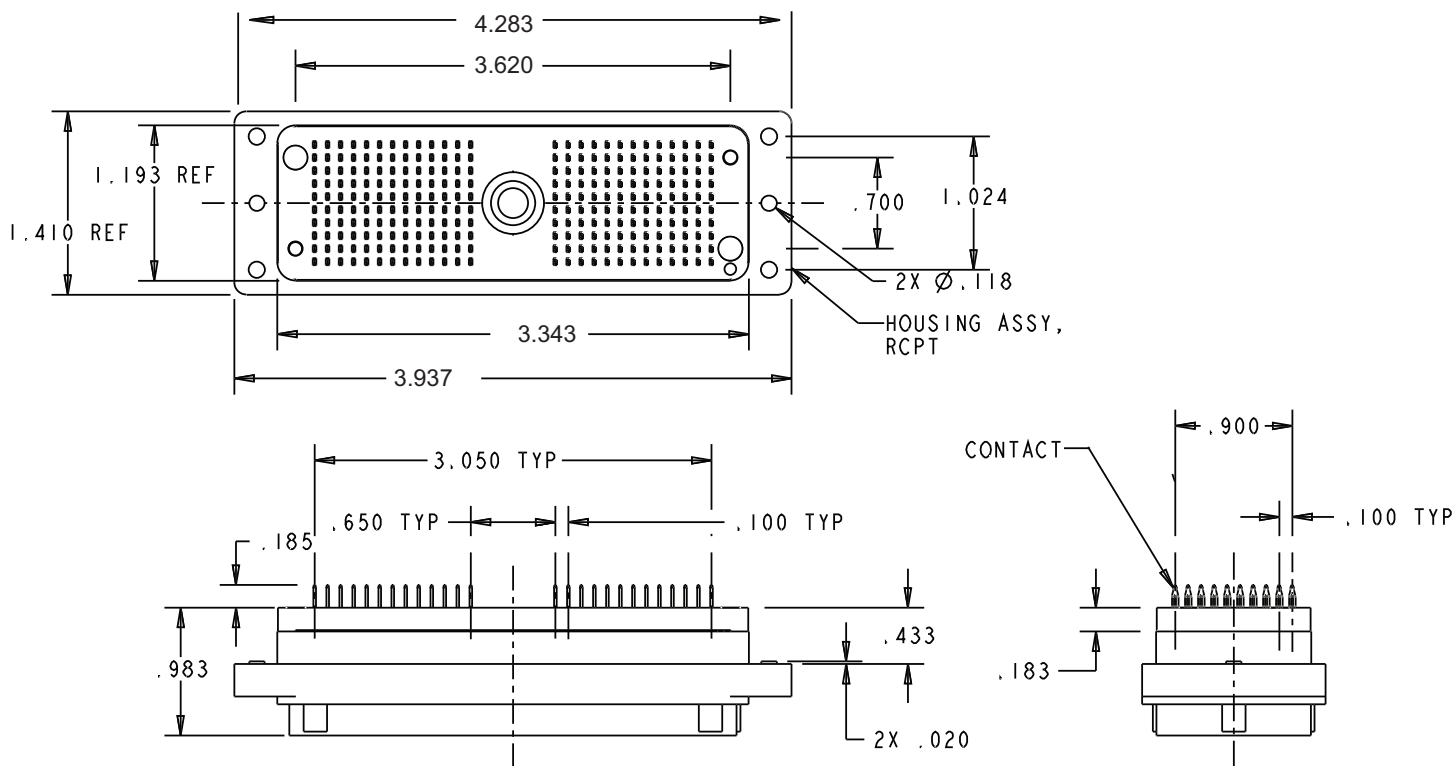



Cannon has combined Zero Insertion Force (ZIF) technology with remote electrical engagement. The DLD Drawer allows the movement of a drawer or panel to effortlessly mate/unmate the connector halves. As an example: electrical sub-systems can be easily removed for service, interchangeability, or portability.

By specifying DLD Drawer interconnect systems, your packaging design is simplified as the need for expensive, complicated, and space-consuming manual actuation mechanisms is eliminated. Tight space requirements no longer restrict your use of ZIF connectors.

The contacts in the DLD Drawer product line do not touch each other while the connector halves are mating. This unique ZIF technology, introduced in the Cannon DL series in the early 1970's, has time-tested proven reliability and durability.

The DLD Drawer's remote mating feature utilizes the axial thrust of a cam to move and mate the contacts. At the end of the cam travel, the cam ramps on a flat surface thereby negating any uncoupling forces.

This rack-and-panel connector is available with crimp or square post contacts, allowing cable, PCB, or flat-flex termination.

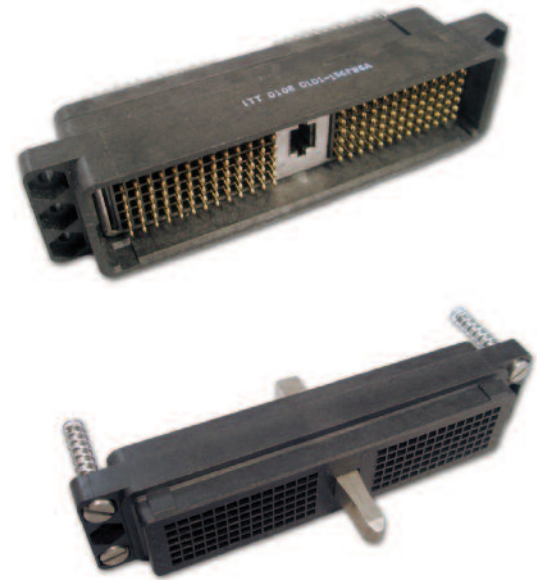

### Standard Materials and Finishes

|                                   |   |
|-----------------------------------|---|
| <b>DLD Housing:</b>               | Glass Filled Thermoplastic, UL 94V-1 rated, Color: Black  |
| <b>Crimp Contacts:</b>            | Copper alloy, 20 or 50 microinches gold over 50 microinches nickel in mated area, gold flash on balance |
| <b>Insulator Retainer (1):</b>    | Stainless steel, Passivated   |
| <b>Actuating Camshaft (2):</b>    | Stainless steel   |
| <b>Spring Mounting Screw (2):</b> | Stainless steel, Passivated   |

### Electrical Data

|                             |                                     |
|-----------------------------|-------------------------------------|
| <b>No. of Contacts:</b>     | 96 and 156 signal                   |
| <b>Wire Size:</b>           | #18 AWG through #42 AWG             |
| <b>Contact Termination:</b> | Crimp, Square Post, Wrap Post, Buss |

### Mechanical Data

|                         |                         |
|-------------------------|-------------------------|
| <b>Actuation:</b>       | Sliding                 |
| <b>Coupling:</b>        | Guide Cam               |
| <b>Polarization:</b>    | Polarizing Posts        |
| <b>Contact Spacing:</b> | 2,54 (.100) Square Grid |
| <b>Shell Styles:</b>    | Plug and Receptacle     |

### Performance Data

|   |   |
|---|---|
| <b>Dielectric Withstanding Voltage:</b> | 1200 VAC RMS - Crimp/Square Post Contact  |
| <b>Insulation Resistance</b>            | 5000 Megaohms minimum   |
| <b>Durability:</b>                      | 100,000 Cycles minimum  |
| <b>Contact Resistance:</b>              | - 15 milliohms maximum - Crimp/Square Post Contact<br>- 20 milliohms maximum - Crimp #30- #32 AWG contact |
| <b>Contact Retention:</b>               | 6 lb (35,564 N) minimum   |

## How to Order

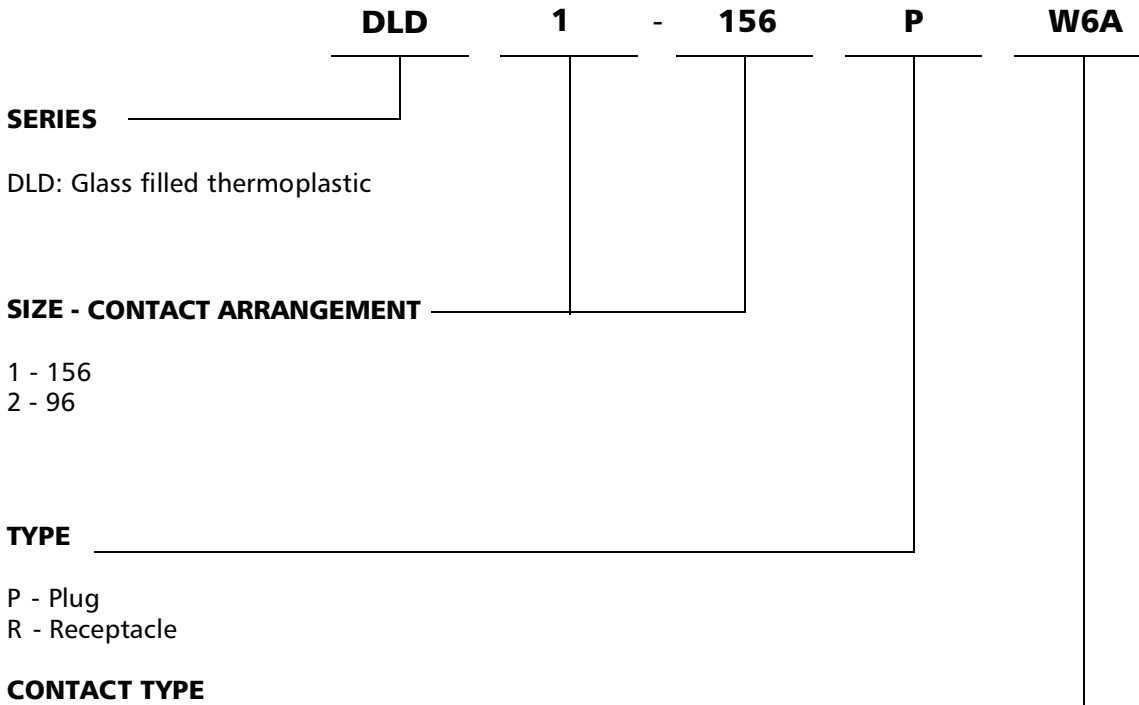

No letter - Crimp #18 thru #42 AWG  
TO BE ORDERED SEPARATELY AND INSTALLED BY CUSTOMER

- W4 - Wrap Post 15,37 (0.605), 20 µinches Gold
- W4A - Wrap Post 15,37 (0.605), 50 µinches Gold, Plug only
- W4B - Wrap Post 15,37 (0.605), 50 µinches Gold, Receptacle only
- W6 - Square Post 7,11 (0.280), 20 µinches Gold
- W6A - Square Post 7,11 (0.280), 50 µinches Gold, Plug only
- W6B - Square Post 7,11 (0.280), 50 µinches Gold, Receptacle only
- W9A - Square Post 3,18 (0.125), 50 µinches Gold
- W9B - Square Post 3,18 (0.125), 50 µinches Gold, Receptacle only

### Plug

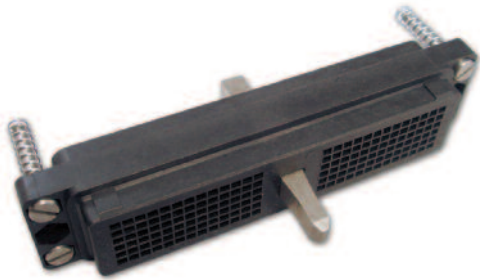

- Crimp contacts are to be ordered separately and to be installed by customer, see pages 48-50.
- For contact cavity arrangements see page 69.
- For panel cutout and mounting hole pattern, see pages 67-68.

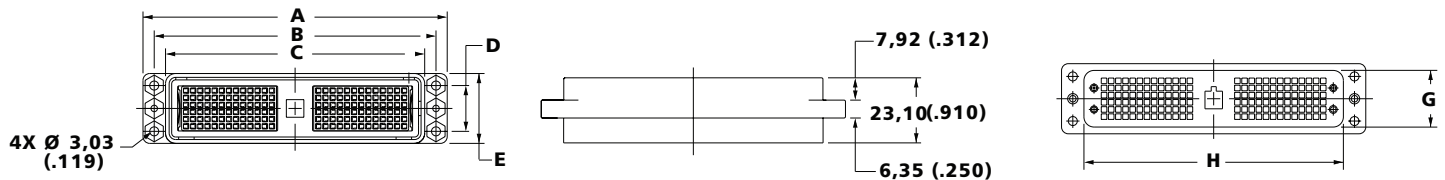

| Description      | A                 | B                 | C                | D                | E                | G                | H                |
|------------------|-------------------|-------------------|------------------|------------------|------------------|------------------|------------------|
| <b>DLD2-96P</b>  | 65,80<br>(2.592)  | 57,91<br>(2.280)  | 50,60<br>(1.994) | 19,38<br>(0.763) | 26,12<br>(1.108) | 24,05<br>(0.947) | 50,60<br>(1.994) |
| <b>DLD1-156P</b> | 108,00<br>(4.255) | 100,03<br>(3.983) | 92,26<br>(3.631) | 16,26<br>(0.640) | 24,90<br>(0.980) | 20,10<br>(0.792) | 92,10<br>(3.626) |

### Receptacle



- Crimp contacts are to be ordered separately and to be installed by customer, see pages 48-50.
- For contact cavity arrangements see page 69.
- For panel cutout and mounting hole pattern, see pages 67-68.

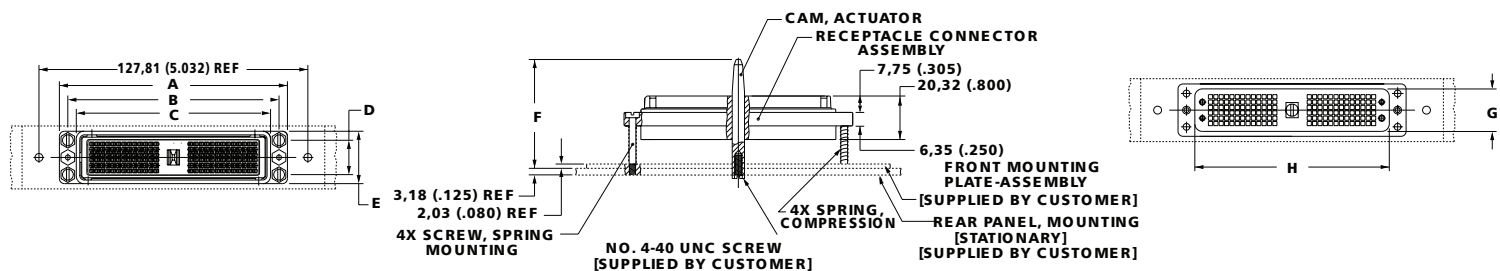

| Description     | A                 | B                 | C                | D                | E                | F                | G                | H                |
|-----------------|-------------------|-------------------|------------------|------------------|------------------|------------------|------------------|------------------|
| <b>DLD2-96R</b> | 65,80<br>(2.592)  | 57,91<br>(2.280)  | 50,60<br>(1.994) | 19,38<br>(.763)  | 28,12<br>(1.108) | 46,87<br>(1.845) | 24,05<br>(0.947) | 50,60<br>(1.994) |
| <b>DLD-156R</b> | 108,00<br>(4.255) | 100,03<br>(3.983) | 92,00<br>(3.622) | 16,26<br>(0.640) | 24,90<br>(0.980) | 46,86<br>(1.845) | 20,10<br>(0.792) | 92,10<br>(3.626) |

Dimensions shown in mm (inch)  
Specifications and dimensions subject to

[www.ittcannon.com](http://www.ittcannon.com)



# Cannon ZIF Connectors

## DLD - Plastic Body - Square / Wrap Post Contacts

### Plug



- For contact cavity arrangements see page 69.
- For panel cutout and mounting hole pattern, see pages 67-68.
- For PC hole pattern, see pages 60-61.

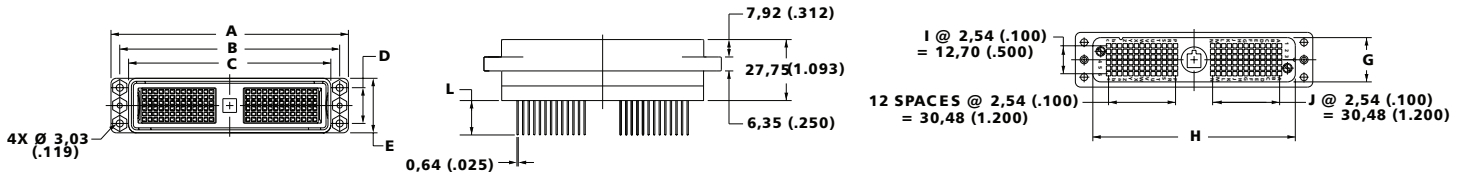

| Description                               | A                 | B                 | C                | D               | E                | G               | H                | I           | J            | L               |
|---|-------------------|-------------------|------------------|-----------------|------------------|-----------------|------------------|-------------|--------------|-----------------|
| <b>DLD2-96PW4</b><br><b>DLD2-96PW4A</b>   | 65,80<br>(2.592)  | 57,91<br>(2.280)  | 50,60<br>(1.994) | 19,38<br>(.763) | 28,12<br>(1.108) | 24,05<br>(.947) | 50,60<br>(1.994) | 7<br>spaces | 6<br>spaces  | 15,37<br>(.605) |
| <b>DLD2-96PW6</b><br><b>DLD2-96PW6A</b>   | 65,80<br>(2.592)  | 57,91<br>(2.280)  | 50,60<br>(1.994) | 19,38<br>(.763) | 28,12<br>(1.108) | 24,05<br>(.947) | 50,60<br>(1.994) | 7<br>spaces | 6<br>spaces  | 7,11<br>(.280)  |
| <b>DLD2-96PW9A</b>                        | 65,80<br>(2.592)  | 57,91<br>(2.280)  | 50,60<br>(1.994) | 19,38<br>(.763) | 28,12<br>(1.108) | 24,05<br>(.947) | 50,60<br>(1.994) | 7<br>spaces | 6<br>spaces  | 3,18<br>(.125)  |
| <b>DLD1-156PW4</b><br><b>DLD1-156PW4A</b> | 108,00<br>(4.255) | 100,03<br>(3.983) | 92,26<br>(3.631) | 16,26<br>(.640) | 24,80<br>(.977)  | 20,10<br>(.792) | 92,10<br>(3.626) | 5<br>spaces | 12<br>spaces | 15,37<br>(.605) |
| <b>DLD1-156PW6</b><br><b>DLD1-156PW6A</b> | 108,00<br>(4.255) | 100,03<br>(3.983) | 92,26<br>(3.631) | 16,26<br>(.640) | 24,90<br>(.980)  | 20,10<br>(.792) | 92,10<br>(3.626) | 5<br>spaces | 12<br>spaces | 7,11<br>(.280)  |
| <b>DLD1-156PW9A</b>                       | 108,00<br>(4.255) | 100,03<br>(3.983) | 92,26<br>(3.631) | 16,26<br>(.640) | 24,90<br>(.980)  | 20,10<br>(.792) | 92,10<br>(3.626) | 5<br>spaces | 12<br>spaces | 3,18<br>(.125)  |

### Receptacle



- For contact cavity arrangements see page 69.
- For panel cutout and mounting hole pattern, see pages 67-68.
- For PC hole pattern, see pages 60-61.

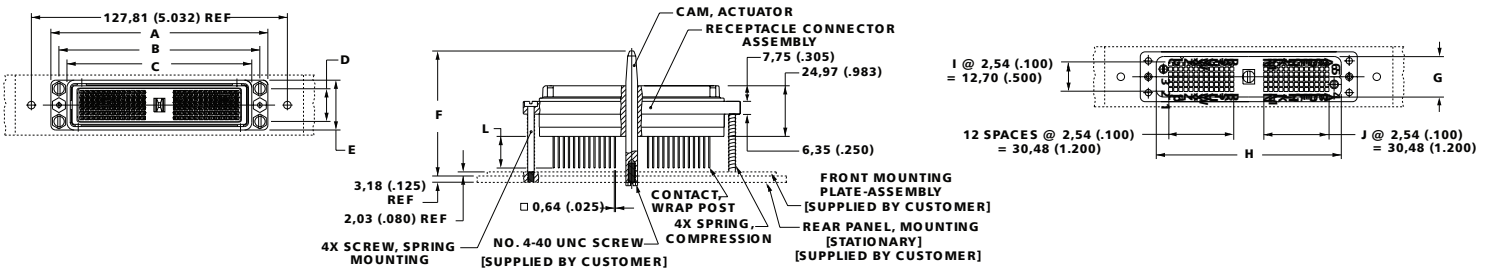

| Description                               | A                 | B                 | C                | D               | E                | F                | G               | H                | I           | J            | L                |
|---|-------------------|-------------------|------------------|-----------------|------------------|------------------|-----------------|------------------|-------------|--------------|------------------|
| <b>DLD2-96RW4</b><br><b>DLD2-96RW4B</b>   | 65,80<br>(2.592)  | 57,91<br>(2.280)  | 50,60<br>(1.994) | 19,38<br>(.763) | 28,12<br>(1.108) | 57,03<br>(1.245) | 24,05<br>(.947) | 50,60<br>(1.994) | 7<br>spaces | 6<br>spaces  | 15,37<br>(0.605) |
| <b>DLD2-96RW6</b><br><b>DLD2-96RW6B</b>   | 65,80<br>(2.592)  | 57,91<br>(2.280)  | 50,60<br>(1.994) | 19,38<br>(.763) | 26,12<br>(1.108) | 57,03<br>(1.245) | 24,05<br>(.947) | 50,60<br>(1.994) | 7<br>spaces | 6<br>spaces  | 7,11<br>(0.280)  |
| <b>DLD1-156RW4</b><br><b>DLD1-156RW4B</b> | 108,00<br>(4.255) | 100,03<br>(3.983) | 92,26<br>(3.631) | 16,26<br>(.640) | 24,80<br>(.977)  | 57,03<br>(1.245) | 20,10<br>(.792) | 92,10<br>(3.626) | 5<br>spaces | 12<br>spaces | 15,37<br>(0.605) |
| <b>DLD1-156RW6</b><br><b>DLD1-156RW6B</b> | 108,00<br>(4.255) | 100,03<br>(3.983) | 92,00<br>(3.622) | 16,26<br>(.640) | 24,90<br>(.980)  | 57,03<br>(1.245) | 20,10<br>(.792) | 92,10<br>(3.626) | 5<br>spaces | 12<br>spaces | 7,11<br>(0.380)  |
| <b>DLD1-156RW9A</b>                       | 108,00<br>(4.255) | 100,03<br>(3.983) | 92,00<br>(3.622) | 16,26<br>(.640) | 24,90<br>(.980)  | 57,03<br>(1.245) | 20,10<br>(.792) | 92,10<br>(3.626) | 5<br>spaces | 12<br>spaces | 7,11<br>(0.380)  |



Dimensions shown in mm (inch)  
Specifications and dimensions subject to change

www.ittcannon.com

Cannon has expanded the DL-ZIF series offering with the addition of the DLM (Metal Shell) versions. The DLM uses a rugged nickel plated aluminum housing. The Shield-Locking Mechanism feature (see illustration below) ensures uniform mating pressure around the perimeter of the mated connector to create an EMI/RFI shield which facilitates compliance of equipment to CE EMC directives.



The DLM Series connectors are intermateable to the DL (Plastic) versions for backwards/forwards compatibility. The DLM Series are offered with all of the DL plastic contacts from crimp, square post, and round PL/RC tail contacts.

Derating Curves

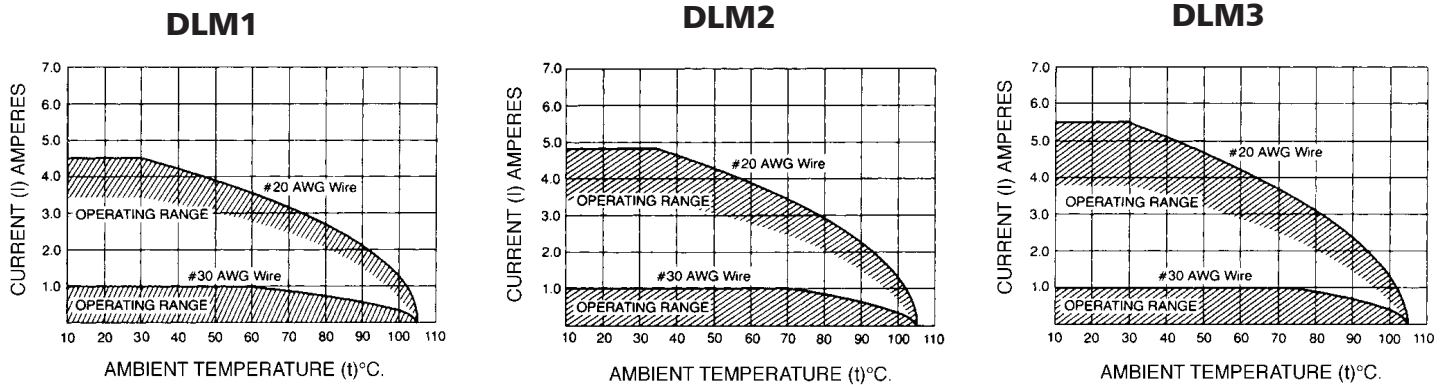

The ambient temperature curves shown represent the rated current carrying capacity of the Cannon DL1/2/3/4, DLM1/2/3 and DLD1/2 electrical connectors, derated to 80% of the values recorded during the methods specified by International Electro-Technical Commission Document 48 (1975).

Current was applied to the total connector (all contacts) in one-half ampere increments and maintained at each current level until thermal stability was achieved. A thermocouple inserted into the "hottest area" of each connector then measured the connector temperature at the same time that an ambient temperature reading was taken. The difference between the two measured values is the heat rise or self-heating created solely by the current flow, and this temperature rise for the current level was deducted from the insulator material rated temperature. These values were then derated to 80% to obtain the curves shown.

## Standard Materials and Finishes

|   |   |
|---|---|
| <b>DLM Housing:</b>   | Aluminum alloy, nickel plated   |
| <b>DLM Insulator Crimp Contacts and Square Post Contacts:</b> | Copper alloy, 20 or 50 microinches gold over 50 microinches nickel in mated area, gold flash on balance |
| <b>PC/RC Contacts:</b>  | Copper alloy, 20 microinches gold over nickel in mated area, Sn over Nickel in tail area                |
| <b>Actuating Camshaft:</b>                                    | Stainless steel, Passivated   |
| <b>Insulator Retainer (Plug only):</b>                        | Stainless steel, Passivated   |

## Electrical Data

|                             |  |
|-----------------------------|--|
| <b>No. of Contacts:</b>     | 60, 96, 156, 260 and 360 signal  |
| <b>Wire Size:</b>           | #18 AWG through #42 AWG  |
| <b>Contact Termination:</b> | <ul style="list-style-type: none"> <li>- PC/RC</li> <li>- Crimp</li> <li>- Square Post</li> <li>- Wrap Post</li> <li>- Buss</li> <li>- Pressfit</li> </ul> |

## Mechanical Data

|                         |                         |
|-------------------------|-------------------------|
| <b>Actuation:</b>       | Single Hand             |
| <b>Coupling:</b>        | Rotating Latch          |
| <b>Polarization:</b>    | Polarizing Posts        |
| <b>Contact Spacing:</b> | 2,54 (.100) Square Grid |
| <b>Shell Styles:</b>    | Plug and Receptacle     |
| <b>Actuation:</b>       | Single Hand             |

## Performance Data

|   |   |
|---|---|
| <b>Dielectric Withstanding Voltage:</b> | 1200 VAC RMS - Crimp/Square Post Contact<br>1000 VAC RMS - PC/RC Contacts   |
| <b>Insulation Resistance</b>            | 5000 Megaohms minimum   |
| <b>Durability:</b>                      | 10,000 Cycles minimum   |
| <b>Contact Resistance:</b>              | <ul style="list-style-type: none"> <li>- 15 milliohms maximum - Crimp/Square Post Contact</li> <li>- 20 milliohms maximum - Crimp #30- #32 AWG contact</li> <li>- 30 milliohms maximum - PC/RC Contact</li> </ul> |
| <b>Contact Retention:</b>               | 8 lb (35,585 N) minimum   |



## How to Order

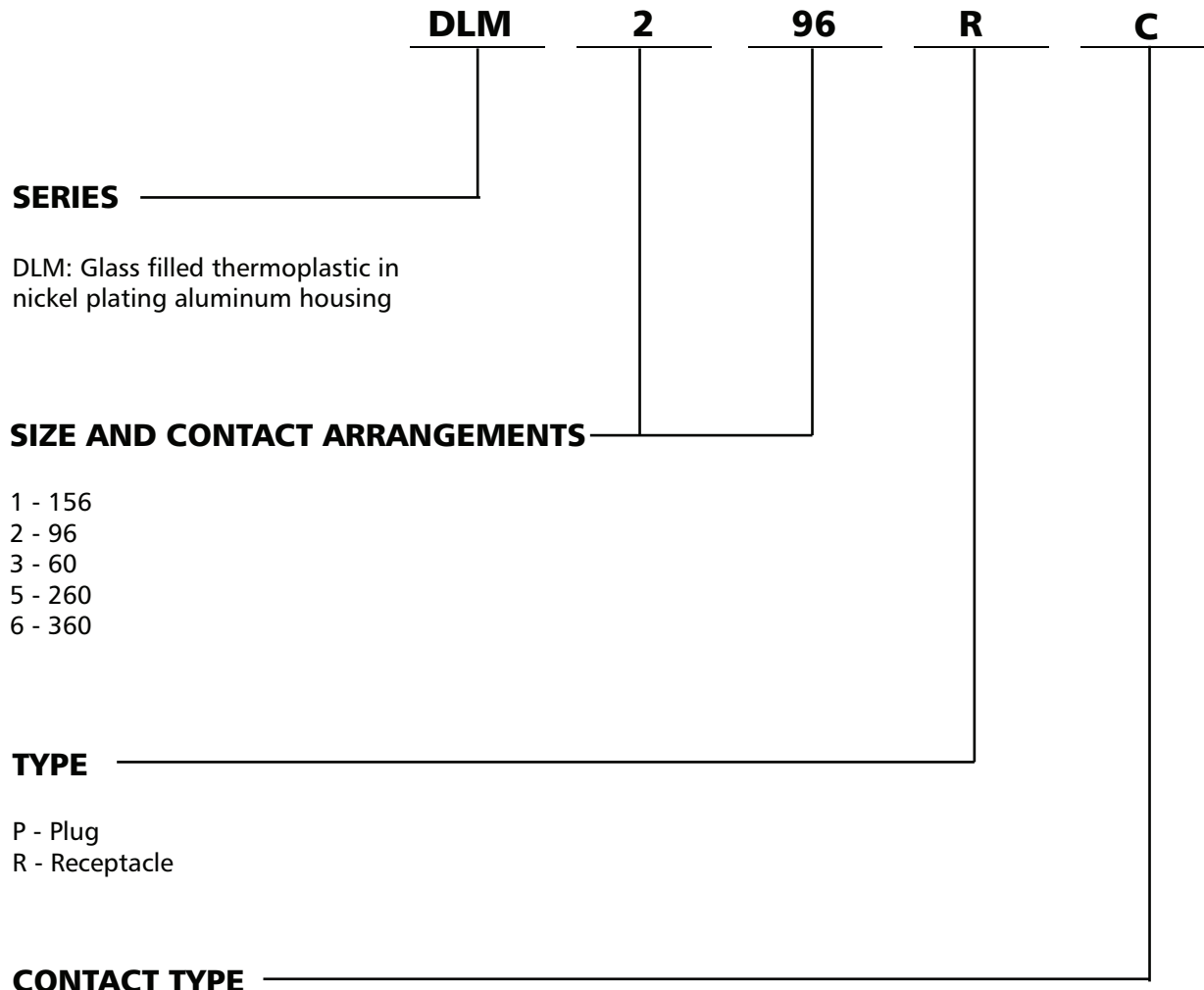

DLM: Glass filled thermoplastic in nickel plating aluminum housing

- 1 - 156
- 2 - 96
- 3 - 60
- 5 - 260
- 6 - 360

- P - Plug
- R - Receptacle

No letter - Crimp #18 thru #42 AWG.  
TO BE ORDERED SEPARATELY AND INSTALLED BY CUSTOMER

- W4 - Wrap Post 15,37 (0.605) 20  $\mu$ inches Gold
- W4A - Wrap Post 15,37 (0.605) 50  $\mu$ inches Gold, Plug only
- W4B - Wrap Post 15,37 (0.605) 50  $\mu$ inches Gold, Receptacle only
- W6 - Square Post 7,11 (0.260) 20  $\mu$ inches Gold
- W6A - Square Post 7,11 (0.260) 50  $\mu$ inches Gold, Plug only
- W6B - Square Post 7,11 (0.260) 50  $\mu$ inches Gold, Receptacle only
- W9A - Square Post 3,18 (0.125), 50  $\mu$ iinches Gold, Plug only
- W9B - Square Post 3,18 (0.125), 50  $\mu$ inches Gold, Receptacle only
- C - F - PC / RC 4,50 (0.177), 20  $\mu$ inches Gold
- PF - Pressfit - DLM5 Plug and Receptacle only

### Plug

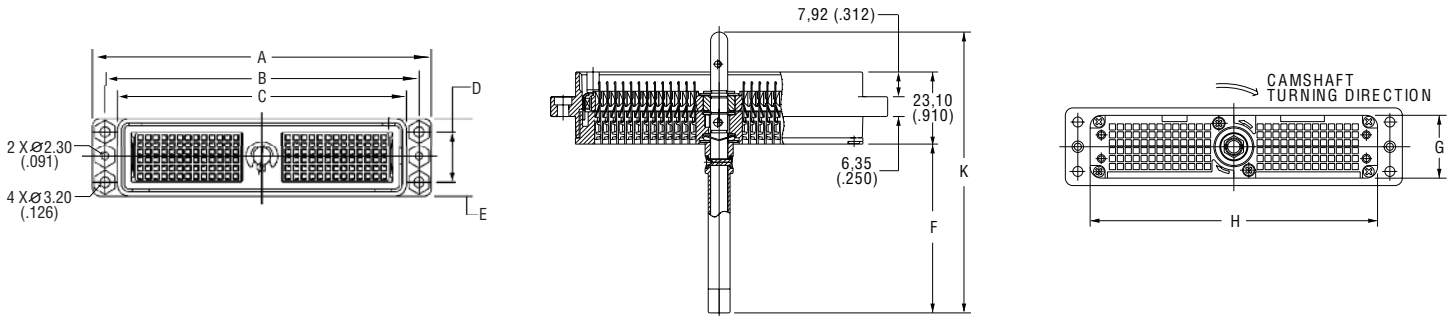

| Description      | A                 | B                 | C                 | D                | E                | F                | G                | H                 | K                 |
|------------------|-------------------|-------------------|-------------------|------------------|------------------|------------------|------------------|-------------------|-------------------|
| <b>DLM3-60P</b>  | 65,80<br>(2.592)  | 57,91<br>(2.280)  | 50,55<br>(1.992)  | 11,89<br>(.468)  | 24,90<br>(.981)  | 38,85<br>(1.530) | 24,90<br>(.981)  | 49,02<br>(1.931)  | 74,75<br>(2.945)  |
| <b>DLM2-96P</b>  | 65,80<br>(2.592)  | 57,91<br>(2.280)  | 50,60<br>(1.994)  | 19,38<br>(.763)  | 28,12<br>(1.108) | 38,85<br>(1.530) | 24,05<br>(.947)  | 50,60<br>(1.994)  | 74,75<br>(2.945)  |
| <b>DLM1-156P</b> | 108,00<br>(4.255) | 100,03<br>(3.983) | 92,00<br>(3.622)  | 16,26<br>(.640)  | 24,80<br>(.977)  | 54,10<br>(2.132) | 20,10<br>(0.792) | 92,10<br>(3.626)  | 90,00<br>(3.546)  |
| <b>DLM5-260P</b> | 108,00<br>(4.255) | 100,03<br>(3.983) | 92,00<br>(3.622)  | 26,00<br>(1.024) | 35,00<br>(1.378) | 54,81<br>(2.158) | 26,00<br>(1.024) | 92,00<br>(3.626)  | 90,00<br>(3.546)  |
| <b>DLM6-360P</b> | 125,00<br>(4.921) | 115,00<br>(4.528) | 104,30<br>(4.106) | 29,00<br>(1.142) | 42,60<br>(1.677) | 69,00<br>(2.717) | 37,80<br>(1.488) | 107,30<br>(4.224) | 104,70<br>(4.122) |

### Receptacle

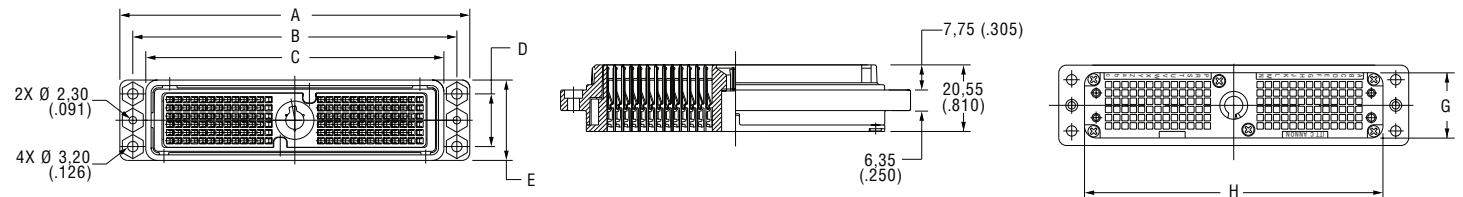

| Description      | A                 | B                 | C                 | D                | E                | G                | H                 |
|------------------|-------------------|-------------------|-------------------|------------------|------------------|------------------|-------------------|
| <b>DLM3-60R</b>  | 65,80<br>(2.592)  | 57,91<br>(2.280)  | 50,55<br>(1.992)  | 11,89<br>(.468)  | 24,90<br>(.981)  | 19,94<br>(.785)  | 49,02<br>(1.931)  |
| <b>DLM2-96PR</b> | 65,80<br>(2.592)  | 57,91<br>(2.280)  | 50,60<br>(1.994)  | 19,38<br>(.763)  | 28,12<br>(1.108) | 24,05<br>(.947)  | 50,60<br>(1.994)  |
| <b>DLM1-156R</b> | 108,00<br>(4.255) | 100,03<br>(3.983) | 92,00<br>(3.622)  | 16,26<br>(.640)  | 24,80<br>(.977)  | 20,10<br>(.792)  | 92,10<br>(3.629)  |
| <b>DLM5-260R</b> | 108,00<br>(4.255) | 100,03<br>(3.983) | 92,00<br>(3.626)  | 26,00<br>(1.024) | 35,00<br>(1.378) | 30,30<br>(1.193) | 92,10<br>(3.629)  |
| <b>DLM6-360R</b> | 125,00<br>(4.921) | 115,00<br>(4.528) | 104,30<br>(4.106) | 29,00<br>(1.142) | 42,60<br>(1.677) | 37,80<br>(1.488) | 107,30<br>(4.224) |

- Order Actuating Handle Kit sold separately, see page 44.
- Crimp contacts are to be ordered separately and to be installed by customer, see pages 48-50.
- For contact cavity arrangements see pages 69-70.
- For panel cutout and mounting hole pattern, see page 66.

- Crimp contacts are to be ordered separately and to be installed by customer, see pages 48-50.
- For contact cavity arrangement see pages 69-70.
- For panel cutout and mounting hole pattern, see page 66.



### Plug



- Order Actuating Handle Kit sold separately, see page 44.
- For contact cavity arrangements see pages 69-70
- For panel cutout and mounting hole pattern, see page 66.
- For PC hole pattern, see pages 59-61.

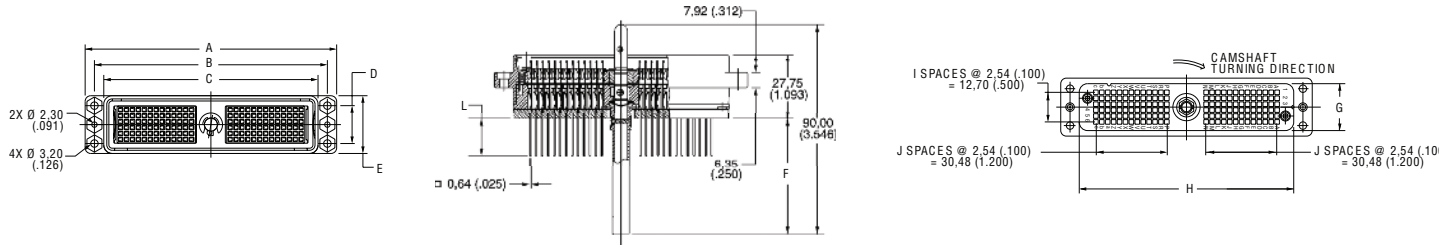

| Description                               | A                 | B                 | C                 | D                | E                | F                | G                | H                 | I           | J            | L               |
|---|-------------------|-------------------|-------------------|------------------|------------------|------------------|------------------|-------------------|-------------|--------------|-----------------|
| <b>DLM3-60PW4</b><br><b>DLM3-60PW4A</b>   | 65,80<br>(2.592)  | 57,91<br>(2.280)  | 50,55<br>(1.992)  | 11,89<br>(.468)  | 24,90<br>(.981)  | 34,20<br>(1.347) | 19,94<br>(.785)  | 49,02<br>(1.931)  | 5<br>spaces | 4<br>spaces  | 15,37<br>(.605) |
| <b>DLM3-60PW6</b><br><b>DLM3-60PW6A</b>   | 65,80<br>(2.592)  | 57,91<br>(2.280)  | 50,55<br>(1.992)  | 11,89<br>(.468)  | 24,90<br>(.981)  | 34,20<br>(1.347) | 19,94<br>(.785)  | 49,02<br>(1.931)  | 5<br>spaces | 4<br>spaces  | 15,37<br>(.605) |
| <b>DLM3-60PW9A</b>                        | 65,80<br>(2.592)  | 57,91<br>(2.280)  | 50,55<br>(1.992)  | 11,89<br>(.468)  | 24,90<br>(.981)  | 34,20<br>(1.347) | 19,94<br>(.785)  | 49,02<br>(1.931)  | 5<br>spaces | 4<br>spaces  | 7,11<br>(.280)  |
| <b>DLM2-96PW4</b><br><b>DLM2-96PW4A</b>   | 65,80<br>(2.592)  | 57,91<br>(2.280)  | 50,60<br>(1.994)  | 19,38<br>(.763)  | 26,12<br>(1.108) | 34,20<br>(1.347) | 24,05<br>(.947)  | 50,60<br>(1.994)  | 7<br>spaces | 6<br>spaces  | 15,37<br>(.605) |
| <b>DLM2-96PW6</b><br><b>DLM2-96PW6A</b>   | 65,80<br>(2.592)  | 57,91<br>(2.280)  | 50,60<br>(1.994)  | 19,38<br>(.763)  | 26,12<br>(1.108) | 34,20<br>(1.347) | 24,05<br>(.947)  | 50,60<br>(1.994)  | 7<br>spaces | 6<br>spaces  | 7,11<br>(.280)  |
| <b>DLM2-96PW9A</b>                        | 65,80<br>(2.592)  | 57,91<br>(2.280)  | 50,60<br>(1.994)  | 19,38<br>(.763)  | 26,12<br>(1.108) | 34,20<br>(1.347) | 24,05<br>(.947)  | 50,60<br>(1.994)  | 7<br>spaces | 6<br>spaces  | 3,18<br>(.125)  |
| <b>DLM1-156PW4</b><br><b>DLM1-156PW4A</b> | 108,00<br>(4.255) | 100,03<br>(3.983) | 92,00<br>(3.622)  | 16,26<br>(.640)  | 24,90<br>(.981)  | 49,45<br>(1.948) | 20,10<br>(.792)  | 92,10<br>(3.626)  | 5<br>spaces | 12<br>spaces | 15,37<br>(.605) |
| <b>DLM1-156PW6</b><br><b>DLM1-156PW6A</b> | 108,00<br>(4.255) | 100,03<br>(3.983) | 92,00<br>(3.622)  | 16,26<br>(.640)  | 24,90<br>(.981)  | 49,45<br>(1.948) | 20,10<br>(.792)  | 92,10<br>(3.626)  | 5<br>spaces | 12<br>spaces | 7,11<br>(.280)  |
| <b>DLM1-156PW9A</b>                       | 108,00<br>(4.255) | 100,03<br>(3.983) | 92,00<br>(3.622)  | 16,26<br>(.640)  | 24,90<br>(.981)  | 49,45<br>(1.948) | 20,10<br>(.792)  | 92,10<br>(3.626)  | 5<br>spaces | 12<br>spaces | 3,18<br>(.125)  |
| <b>DLM5-260PW4</b><br><b>DLM5-260PW4A</b> | 108,00<br>(4.255) | 100,03<br>(3.983) | 92,00<br>(3.622)  | 26,00<br>(1.024) | 35,00<br>(1.378) | 49,90<br>(1.965) | 30,30<br>(1.193) | 92,10<br>(3.626)  | 9<br>spaces | 12<br>spaces | 15,37<br>(.604) |
| <b>DLM5-260PW6</b><br><b>DLM5-260PW6A</b> | 108,00<br>(4.255) | 100,03<br>(3.983) | 92,00<br>(3.622)  | 26,00<br>(1.024) | 35,00<br>(1.378) | 49,90<br>(1.965) | 30,30<br>(1.193) | 92,10<br>(3.626)  | 9<br>spaces | 12<br>spaces | 7,11<br>(.280)  |
| <b>DLM5-260PW9A</b>                       | 108,00<br>(4.255) | 100,03<br>(3.983) | 92,00<br>(3.622)  | 26,00<br>(1.024) | 35,00<br>(1.378) | 49,90<br>(1.965) | 30,30<br>(1.193) | 92,10<br>(3.626)  | 9<br>spaces | 12<br>spaces | 3,18<br>(.125)  |
| <b>DLM6-260PW4</b><br><b>DLM6-360PW4A</b> | 125,00<br>(4.291) | 115,00<br>(4.528) | 104,30<br>(4.106) | 29,00<br>(1.142) | 42,60<br>(1.677) | 64,30<br>(2.531) | 37,80<br>(1.488) | 107,30<br>(4.224) | 9<br>spaces | 14<br>spaces | 15,37<br>(.604) |
| <b>DLM6-360PW6</b><br><b>DLM6-360PW6A</b> | 125,00<br>(4.291) | 115,00<br>(4.528) | 104,30<br>(4.106) | 29,00<br>(1.142) | 42,60<br>(1.677) | 64,30<br>(2.531) | 37,80<br>(1.488) | 107,30<br>(4.224) | 9<br>spaces | 14<br>spaces | 7,11<br>(.280)  |
| <b>DLM6-360PW9A</b>                       | 125,00<br>(4.291) | 115,00<br>(4.528) | 104,30<br>(4.106) | 29,00<br>(1.142) | 42,60<br>(1.677) | 64,30<br>(2.531) | 37,80<br>(1.488) | 107,30<br>(4.224) | 9<br>spaces | 14<br>spaces | 3,18<br>(.125)  |

**Notes:**

Front removable 0,64 (0.025) square posts 2,54 (0.100) Centers.  
1 space at 2,54 (0.100)

Dimensions shown in mm (inch)

Specifications and dimensions subject to change

### Receptacle



- For contact cavity arrangements see pages 69-70.
- For panel cutout and mounting hole pattern, see page 66.
- For PC hole pattern, see pages 59-61.

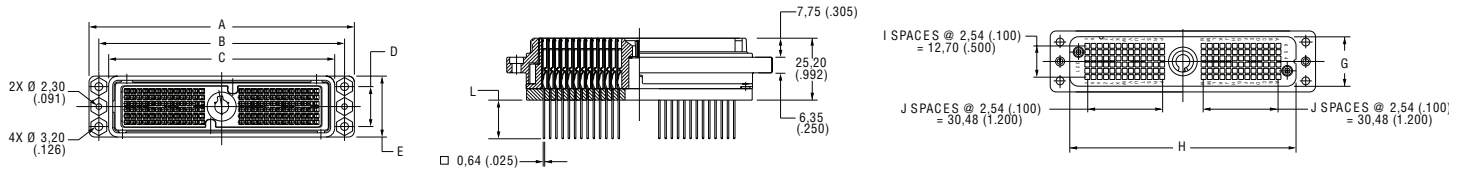

| Description                               | A                 | B                 | C                 | D                | E                | G                | H                 | I            | J            | L               |
|---|-------------------|-------------------|-------------------|------------------|------------------|------------------|-------------------|--------------|--------------|-----------------|
| <b>DLM3-60RW4</b><br><b>DLM3-60RW4B</b>   | 65,80<br>(2.592)  | 57,91<br>(2.280)  | 50,55<br>(1.992)  | 11,89<br>(.466)  | 24,80<br>(.980)  | 19,94<br>(.785)  | 49,02<br>(1.931)  | 5<br>spaces  | 4<br>spaces  | 15,37<br>(.605) |
| <b>DLM3-60RW6</b><br><b>DLM3-60RW6B</b>   | 65,80<br>(2.592)  | 57,91<br>(2.280)  | 50,55<br>(1.992)  | 11,89<br>(.466)  | 24,80<br>(1.360) | 19,94<br>(.785)  | 49,02<br>(1.931)  | 5<br>spaces  | 4<br>spaces  | 7,11<br>(.280)  |
| <b>DLM3-60RW9B</b>                        | 65,80<br>(2.592)  | 57,91<br>(2.280)  | 50,55<br>(1.992)  | 11,89<br>(.466)  | 24,80<br>(1.360) | 19,94<br>(.785)  | 49,02<br>(1.931)  | 5<br>spaces  | 4<br>spaces  | 3,18<br>(.125)  |
| <b>DLM2-96RW4</b><br><b>DLM2-96RW4B</b>   | 65,80<br>(2.592)  | 57,91<br>(2.280)  | 50,60<br>(1.994)  | 19,38<br>(.763)  | 28,12<br>(1.108) | 24,05<br>(.947)  | 50,60<br>(1.994)  | 7<br>spaces  | 6<br>spaces  | 15,37<br>(.605) |
| <b>DLM2096RW6</b><br><b>DLM2-96RW6B</b>   | 65,80<br>(2.592)  | 57,91<br>(2.280)  | 50,60<br>(1.994)  | 19,38<br>(.763)  | 28,12<br>(1.108) | 24,05<br>(.947)  | 50,60<br>(1.994)  | 7<br>spaces  | 6<br>spaces  | 7,11<br>(.280)  |
| <b>DLM2-96RW9B</b>                        | 65,80<br>(2.592)  | 57,91<br>(2.280)  | 50,60<br>(1.994)  | 19,38<br>(.763)  | 28,12<br>(1.108) | 24,05<br>(.947)  | 50,60<br>(1.994)  | 7<br>spaces  | 6<br>spaces  | 3,18<br>(.125)  |
| <b>DLM1-156RW4</b><br><b>DLM1-156RW4B</b> | 108,00<br>(4.255) | 100,03<br>(3.983) | 92,00<br>(3.622)  | 16,26<br>(.640)  | 24,80<br>(.976)  | 20,10<br>(.792)  | 92,10<br>(3.626)  | 5<br>spaces  | 12<br>spaces | 15,37<br>(.605) |
| <b>DLM1-156RW6</b><br><b>DLM1-156RW6B</b> | 108,00<br>(4.255) | 100,03<br>(3.983) | 92,00<br>(3.622)  | 16,26<br>(.640)  | 24,80<br>(.976)  | 20,10<br>(.792)  | 92,10<br>(3.626)  | 5<br>spaces  | 12<br>spaces | 7,11<br>(.380)  |
| <b>DLM1-156RW9B</b>                       | 108,00<br>(4.255) | 100,03<br>(3.983) | 92,00<br>(3.622)  | 16,26<br>(.640)  | 24,80<br>(.976)  | 20,10<br>(.792)  | 92,10<br>(3.626)  | 5<br>spaces  | 12<br>spaces | 3,18<br>(.125)  |
| <b>DLM5-260RW4</b><br><b>DLM5-260RW4B</b> | 108,00<br>(4.255) | 100,03<br>(3.983) | 92,00<br>(3.622)  | 26,00<br>(1.024) | 49,61<br>(1.953) | 30,30<br>(1.193) | 92,10<br>(3.626)  | 9<br>spaces  | 12<br>spaces | 15,37<br>(.604) |
| <b>DLM5-260RW6</b><br><b>DLM5-260RW6B</b> | 108,00<br>(4.255) | 100,03<br>(3.983) | 92,00<br>(3.622)  | 26,00<br>(1.024) | 49,61<br>(1.953) | 30,30<br>(1.193) | 92,10<br>(3.626)  | 9<br>spaces  | 12<br>spaces | 7,11<br>(.280)  |
| <b>DLM5-260RW9B</b>                       | 108,00<br>(4.255) | 100,03<br>(3.983) | 92,00<br>(3.622)  | 26,00<br>(1.024) | 49,61<br>(1.953) | 30,30<br>(1.193) | 92,10<br>(3.626)  | 9<br>spaces  | 12<br>spaces | 3,18<br>(.125)  |
| <b>DLM6-360RW4</b><br><b>DLM6-360RW4B</b> | 125,00<br>(4.291) | 115,00<br>(4.528) | 104,30<br>(4.106) | 29,00<br>(1.142) | 42,60<br>(1.677) | 37,80<br>(1.488) | 107,30<br>(4.224) | 11<br>spaces | 14<br>spaces | 15,37<br>(.604) |
| <b>DLM6-360RW6</b><br><b>DLM6-360RW6B</b> | 125,00<br>(4.291) | 115,00<br>(4.528) | 104,30<br>(4.106) | 29,00<br>(1.142) | 42,60<br>(1.677) | 37,80<br>(1.488) | 107,30<br>(4.224) | 11<br>spaces | 14<br>spaces | 7,11<br>(.280)  |
| <b>DLM360RW9B</b>                         | 125,00<br>(4.291) | 115,00<br>(4.528) | 104,30<br>(4.106) | 29,00<br>(1.142) | 42,60<br>(1.677) | 37,80<br>(1.488) | 107,30<br>(4.224) | 11<br>spaces | 14<br>spaces | 3,18<br>(.125)  |

Notes:  
Front removable 0,64 (0.025) square posts 2,54 (0.100) Centers.  
1 space at 2,54 (0.100)



### Plug



- Order Actuating Handle Kit sold separately, see page 44.
- For contact cavity arrangements see pages 69-70.
- For panel cutout and mounting hole pattern, see page 66.
- For PC hole pattern, see pages 59-61.

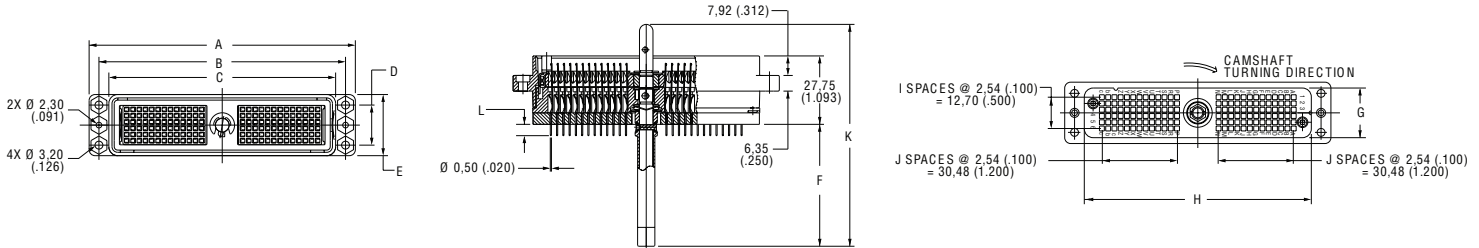

| Description         | A                 | B                 | C                 | D                | E                | F                | G                | H                 | I  | J  | K                 | L              |
|---------------------|-------------------|-------------------|-------------------|------------------|------------------|------------------|------------------|-------------------|----|----|-------------------|----------------|
| <b>DLM3-60PC-F</b>  | 65,80<br>(2.592)  | 57,91<br>(2.280)  | 50,55<br>(1.992)  | 11,89<br>(.468)  | 24,90<br>(.980)  | 34,20<br>(1.347) | 19,94<br>(.785)  | 49,02<br>(1.994)  | 5  | 4  | 74,75<br>(2.945)  | 4,60<br>(.181) |
| <b>DLM2-96PC-F</b>  | 65,80<br>(2.592)  | 57,91<br>(2.280)  | 50,60<br>(1.994)  | 19,38<br>(.763)  | 28,12<br>(1.108) | 34,20<br>(1.347) | 24,05<br>(.947)  | 50,60<br>(1.994)  | 7  | 6  | 74,75<br>(2.945)  | 4,60<br>(.181) |
| <b>DLM1-156PC-F</b> | 108,00<br>(4.255) | 100,03<br>(3.983) | 92,20<br>(3.626)  | 16,26<br>(.640)  | 24,80<br>(0.977) | 49,45<br>(1.948) | 20,10<br>(0.792) | 92,10<br>(3.626)  | 5  | 12 | 90,00<br>(3.546)  | 4,60<br>(.181) |
| <b>DLM5-260PC-F</b> | 108,00<br>(4.255) | 100,03<br>(3.983) | 92,00<br>(3.626)  | 26,00<br>(1.024) | 35,00<br>(1.378) | 49,90<br>(1.965) | 30,30<br>(1.193) | 92,10<br>(3.626)  | 9  | 12 | 90,00<br>(3.546)  | 4,60<br>(.181) |
| <b>DLM6-360PC-F</b> | 125,00<br>(4.291) | 115,00<br>(4.528) | 104,30<br>(4.106) | 29,00<br>(1.142) | 42,60<br>(1.677) | 64,30<br>(2.531) | 37,80<br>(1.488) | 107,30<br>(4.224) | 11 | 14 | 104,70<br>(4.122) | 4,60<br>(.181) |

Notes:  
1 space at 2,54 (0.100)

### Receptacle



- For contact cavity arrangements see pages 69-70.
- For panel cutout and mounting hole pattern, see page 66.
- For PC hole pattern, see pages 59-61.

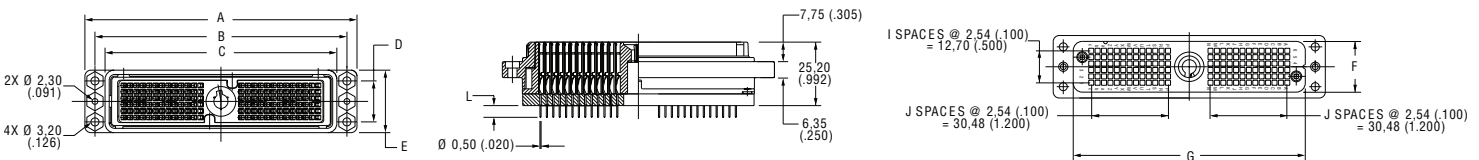

| Description         | A                 | B                 | C                 | D                | E                | G                | H                 | I  | J  | L              |
|---------------------|-------------------|-------------------|-------------------|------------------|------------------|------------------|-------------------|----|----|----------------|
| <b>DLM3-60RC-F</b>  | 65,80<br>(2.592)  | 57,91<br>(2.280)  | 50,55<br>(1.992)  | 11,89<br>(.468)  | 24,90<br>(.980)  | 19,94<br>(.785)  | 49,02<br>(1.994)  | 5  | 4  | 4,60<br>(.181) |
| <b>DLM2-96RC-F</b>  | 65,80<br>(2.592)  | 57,91<br>(2.280)  | 50,60<br>(1.994)  | 19,38<br>(.763)  | 28,12<br>(1.108) | 24,05<br>(.947)  | 50,60<br>(1.994)  | 7  | 6  | 4,60<br>(.181) |
| <b>DLM1-156RC-F</b> | 108,00<br>(4.255) | 100,03<br>(3.983) | 92,20<br>(3.626)  | 16,26<br>(.640)  | 24,80<br>(.977)  | 20,10<br>(0.792) | 92,10<br>(3.626)  | 5  | 12 | 4,60<br>(.181) |
| <b>DLM5-260RC-F</b> | 108,00<br>(4.255) | 100,03<br>(3.983) | 92,00<br>(3.626)  | 26,00<br>(1.024) | 35,00<br>(1.378) | 30,30<br>(1.193) | 92,10<br>(3.626)  | 9  | 12 | 4,60<br>(.181) |
| <b>DLM6-360RC-F</b> | 125,00<br>(4.291) | 115,00<br>(4.528) | 104,30<br>(4.106) | 29,00<br>(1.142) | 42,60<br>(1.677) | 37,80<br>(1.488) | 107,30<br>(4.224) | 11 | 14 | 4,60<br>(.181) |

Notes:  
1 space at 2,54 (0.100)

Dimensions shown in mm (inch)  
Specifications and dimensions subject to change

www.ittcannon.com



# Cannon ZIF Connectors

## DLM - Metal Body - Pressfit Contacts

### Plug



- Order Actuating Handle Kit sold separately, see page 44.
- For contact cavity arrangements see page 61.
- For panel cutout and mounting hole pattern, see page 66.
- For PC hole pattern, see page 62.

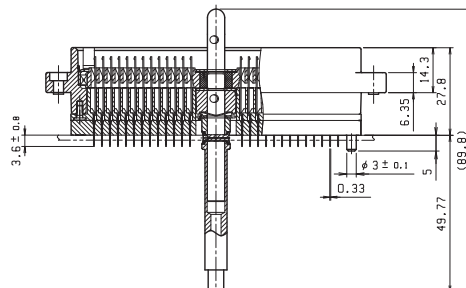
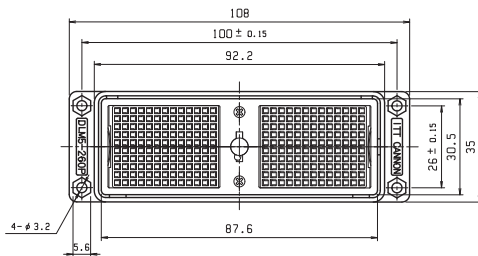

| Part Number | Nomenclature |
|-------------|--------------|
| 127050-0378 | DLM5-260P-PF |

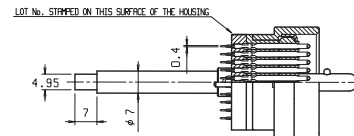
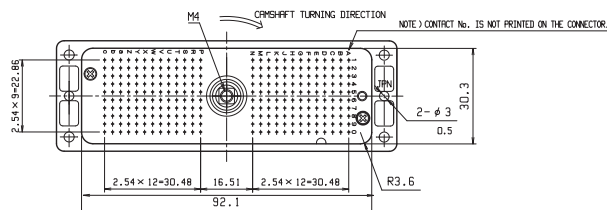

### Receptacle



- For contact cavity arrangements see page 61
- For panel cutout and mounting hole pattern, see page 66
- For PC hole pattern, see page 62

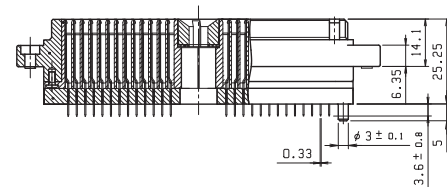
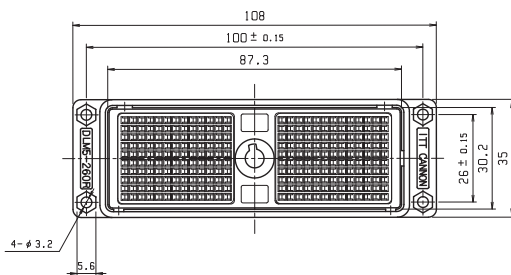

| Part Number | Nomenclature |
|-------------|--------------|
| 127050-0313 | DLM5-260R-PF |

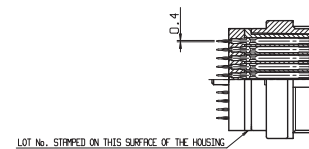
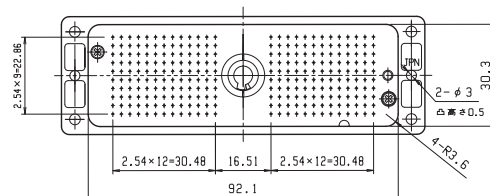

Dimensions shown in mm (inch)  
Specifications and dimensions subject to change

www.ittcannon.com

The Cannon DL4 Series of Zero Insertion Force (ZIF) connectors fill the need in the commercial/industrial, aerospace/military, computer, and peripheral equipment marketplace for low-cost, high performance multiple wire power and signal connectors. The DL4 Series is a panel mounted connector with easy actuating lever from the side.

DL connectors feature: a minimum rated life of 20,000 complete mating and unmating cycles with no performance loss; can be mated and unmated in less than two seconds even with as many as 624 contacts; and they cost less (often as much as 25% less) per mated line than singular high-density rack-and-panel connectors.

*Simple. Effective. Reliable. Durable.*

Combining their special design with commercial-grade materials and low cost crimp. PCB and wrappable hermaphroditic contacts, that may be hand or machine terminated, makes the DL Series of ZIF connectors the finest low-cost-per-mated-line I/O connectors available today.



## Derating Curves

### DL4

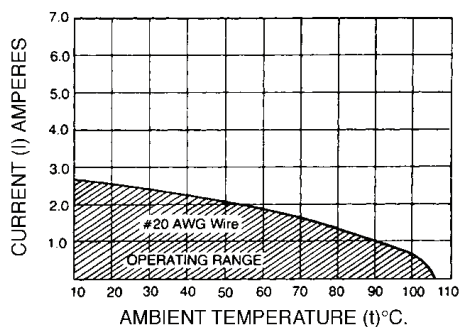

The ambient temperature curves shown represent the rated current carrying capacity of the Cannon DL electrical connectors, derated to 80% of the values recorded during the methods specified by International Electro-Technical Commission Document 48 (1975). Current was applied to the total connector (all contacts) in one-half ampere increments and maintained at each current level until thermal stability was achieved. A thermocouple inserted into the "hottest area" of each connector then measured the connector temperature at the same time that an ambient temperature reading was taken. The difference between the two measured values is the heat rise or self-heating created solely by the current flow, and this temperature rise for the current level was deducted from the insulator material rated temperature. These values were then derated to 80% to obtain the curves shown.

## Standard Materials and Finishes

|   |   |
|---|---|
| <b>Insulator:</b>                               | Glass filled thermoplastic, UL 94V-1 rated, Color: Black  |
| <b>Housing Frame:</b>                           | Aluminum alloy, nickel plated   |
| <b>Mounting Plate:</b>                          | Aluminum alloy, clear anodized  |
| <b>Crimp Contacts and Square Post Contacts:</b> | Copper alloy, 20 or 50 $\mu$ inches gold over 50 $\mu$ inches nickel in mated area, gold flash on balance |
| <b>Actuating Camshaft:</b>                      | Stainless steel, Passivated   |
| <b>Insulator Retainer (Plug only):</b>          | Stainless steel, Passivated   |

## Electrical Data

|                             |   |
|-----------------------------|---|
| <b>No. of Contacts:</b>     | 624, 1248*, and 2496* signal                      |
| <b>Wire Size:</b>           | #18 AWG through #42 AWG                           |
| <b>Contact Termination:</b> | - Crimp<br>- Square Post<br>- Wrap Post<br>- Buss |

## Mechanical Data

|                         |                         |
|-------------------------|-------------------------|
| <b>Actuation:</b>       | Lever                   |
| <b>Coupling:</b>        | Dual Latch              |
| <b>Polarization:</b>    | -                       |
| <b>Contact Spacing:</b> | 2,54 (.100) Square Grid |
| <b>Shell Styles:</b>    | Plug and Receptacle     |

## Performance Data

|   |   |
|---|---|
| <b>Dielectric Withstanding Voltage:</b> | 750 VAC RMS - DL4   |
| <b>Insulation Resistance</b>            | 5000 Megaohms minimum   |
| <b>Durability:</b>                      | 20,000 Cycles minimum   |
| <b>Contact Resistance:</b>              | - 15 milliohms maximum - Crimp/Square Post Contact<br>- 20 milliohms maximum - Crimp #30- #32 AWG contact |
| <b>Contact Retention:</b>               | 8 lb (35,585 N) minimum   |

\* Contact Factory for availability

How to Order

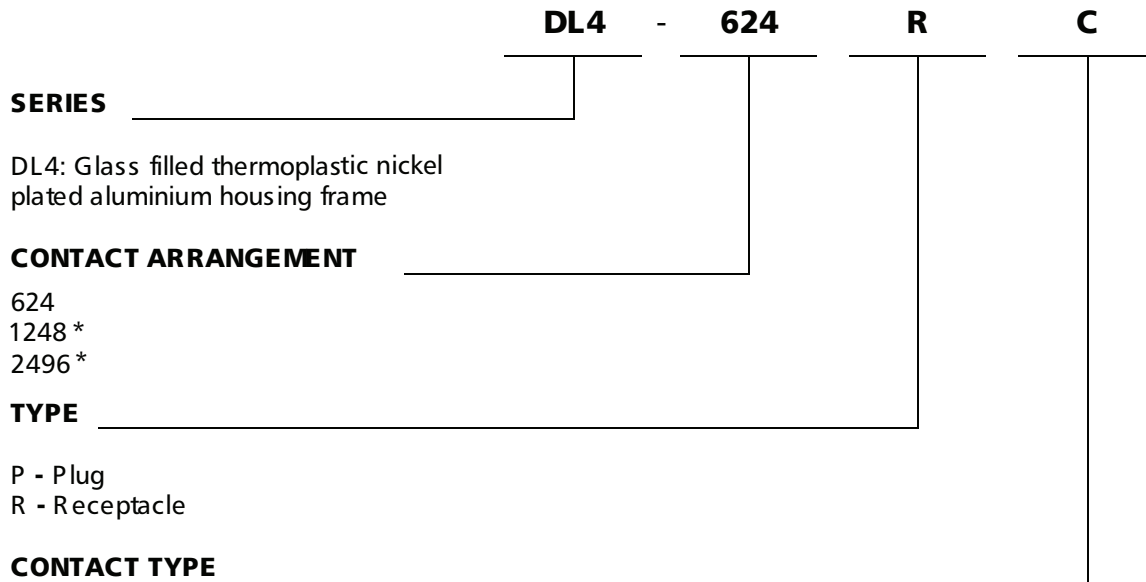

TO BE ORDERED SEPERATALY AND INSTALLED BY CUSTOMER

- W4 - Wrap Post 15,37 (0.605), 20 µinches Gold
- W4A - Wrap Post 15,37 (0.605), 50 µinches Gold, Plug only
- W4B - Wrap Post 15,37 (0.605), 50 µinches Gold, Receptacle only
- W6 - Square Post 7,11 (0.280), 20 µinches Gold
- W6A - Square Post 7,11 (0.280), 50 µinches Gold, Plug only
- W6B - Square Post 7,11 (0.280), 50 µinches Gold, Receptacle only
- W9A - Square Post 3,18 (0.125), 50 µinches Gold, Plug only
- W9B - Square Post 3,18 (0.125), 50 µinches Gold, Receptacle only

\* Contact Factory for availability

### Plug

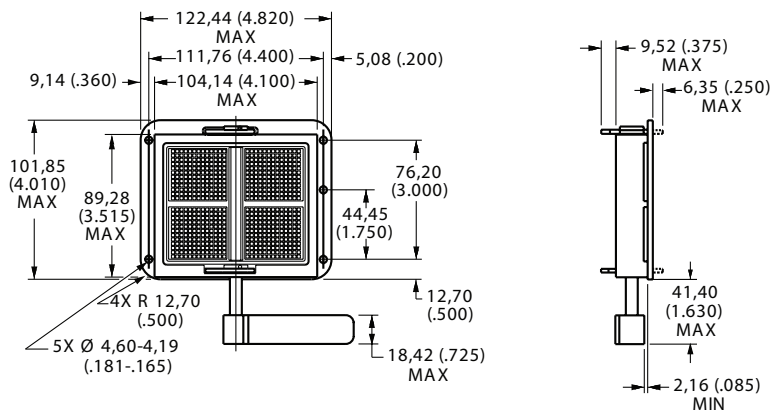

| Part Number | Nomenclature |
|-------------|--------------|
| 110959-0002 | DL4-624P     |

- Actuating Handles are part of the completed assembly.
- Crimp contacts are to be ordered separately and to be installed by customer, see pages 48-50.
- For contact cavity arrangements see page 70.
- For panel cutout and mounting hole pattern, see page 66.

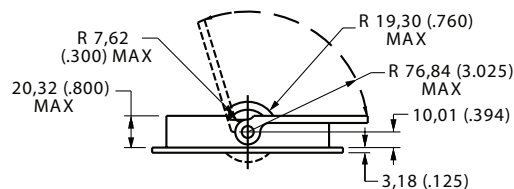

### Receptacle

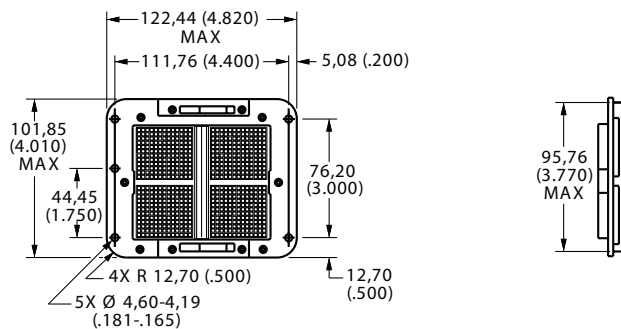
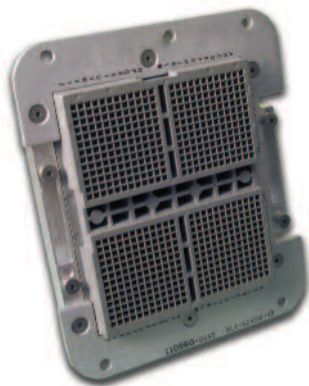

| Part Number | Nomenclature |
|-------------|--------------|
| 110960-0002 | DL4-624R     |

- Crimp contacts are to be ordered separately and to be installed by customer, see pages 48-50.
- For contact cavity arrangements see page 70.
- For panel cutout and mounting hole pattern, see page 66.

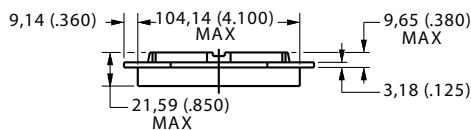



### Plug

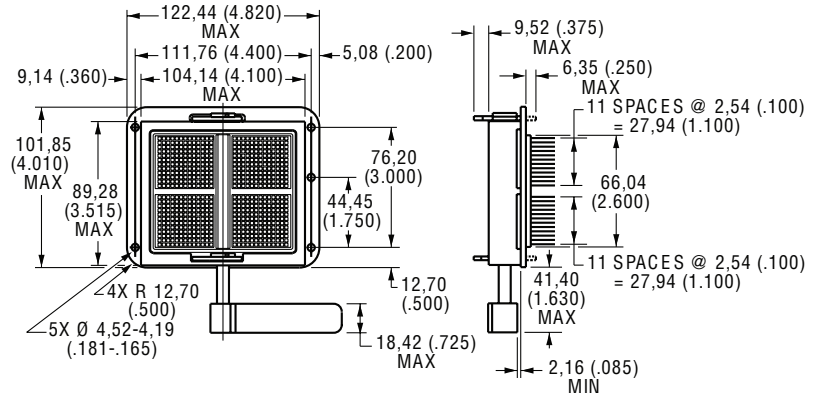
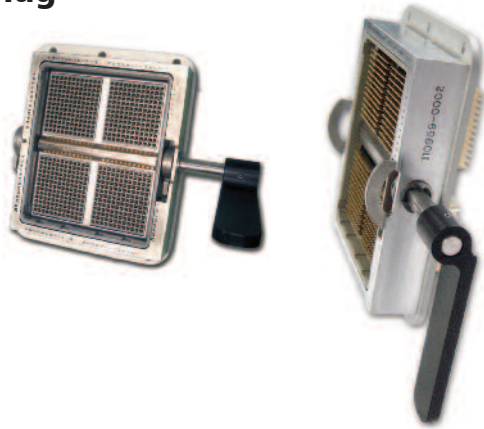

| Nomenclature                             | L            |
|--|--------------|
| <b>DL4-624-PW4</b><br><b>DL4-624PW4A</b> | 15,37 (.605) |
| <b>DL4-624PW6</b><br><b>DL4-624PW6A</b>  | 7,11 (.280)  |
| <b>DL4-624PW9A</b>                       | 3,18 (.125)  |

Front removable 0,64 (0.025) square posts 2,54 (0.100) Centers.

- Actuating handles are part of the completed assembly.
- For contact cavity arrangements see page 70.
- For panel cutout and mounting hole pattern, see page 66.

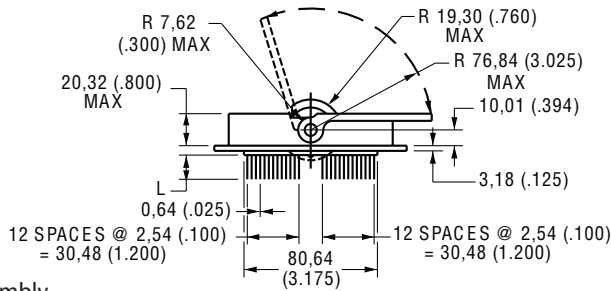

### Receptacle

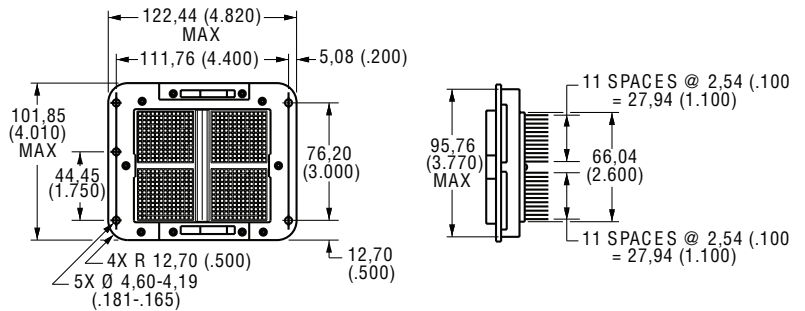
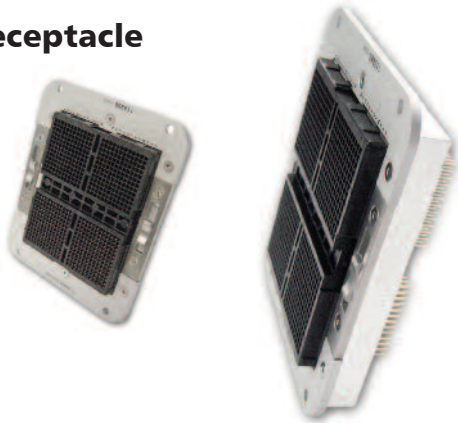

| Nomenclature                            | L            |
|---|--------------|
| <b>DL4-624RW4</b><br><b>DL4-624RW4A</b> | 15,37 (.605) |
| <b>DL4-624RW6</b><br><b>DL4-624RW6A</b> | 7,11 (.280)  |
| <b>DL4-624RW9B</b>                      | 3,18 (1.125) |

Front removable 0,64 (0.025) square posts 2,54 (0.100) Centers

- For contact cavity arrangement see page 70.
- For panel cutout and mounting hole pattern, see page 66.

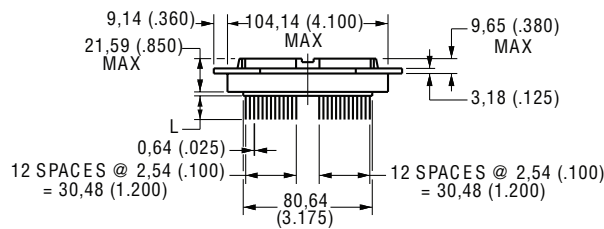

Dimensions shown in mm (inch)  
Specifications and dimensions subject to change

Cannon has developed a 'Resilient Contact' that provides reliable performance with contact wiping action directly on a PCB pad. A high density contact module enables a high pin count connector and flexibility. The nickel plated aluminum housing along with the embedded grounding springs offer superior performance under the harshest EMI conditions. The DLP, like that of the DL, is capable of over 10,000 mating cycles. With the PCB acting as the mated contacts, electronics can be mounted at the signal source, thus reducing cross talk and minimizing real-estate. The DLP-408 is offered with mechanical shutters to meet the IEC requirements for finger protection.

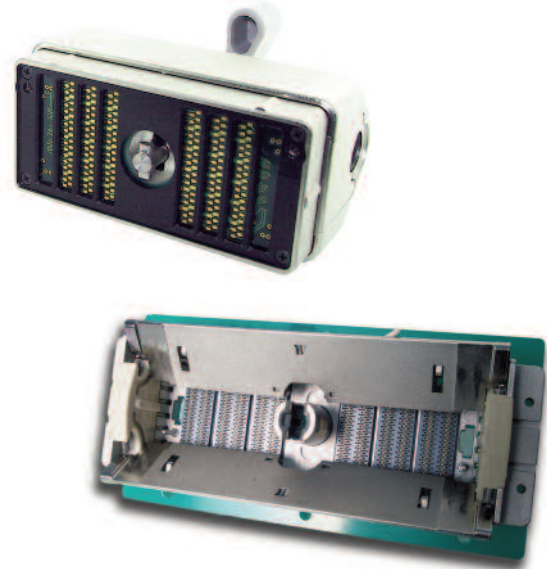

## Materials and Finishes

|                           |  |
|---------------------------|--|
| <b>Housing</b>            | Aluminum Alloy (DLP136, 204, 272). Zinc Alloy (DLP408) Nickel Plated |
| <b>Actuating Camshaft</b> | Stainless Steel, Passivated  |

## Electrical Data

|                             |  |
|-----------------------------|--|
| <b>No. of Contacts:</b>     | 136, 204, 272, 408   |
| <b>Wire Size:</b>           | N/A  |
| <b>Contact Termination:</b> | Receptacle<br>DIP Soldering to PCB - DLP 136, 204, 272<br>Pressfit to PCB (408)  |
|                             | Plug<br>Cable termination to PCB<br>Direct soldering to daughter board stacked to PCB<br>Interface connector between cable and PCB |

## Mechanical Data

|                         |   |
|-------------------------|---|
| <b>Actuation:</b>       | Single Hand   |
| <b>Coupling:</b>        | Rotating Latch  |
| <b>Polarization:</b>    | Polarizing Posts  |
| <b>Contact Spacing:</b> | 1.9 (0.075 Pitch (DLP136 204, 272)), 1.6 (0.063) Pitch (DLP408) |
| <b>Shell Styles:</b>    | Plug and Receptacle   |

## Performance Data

|   |                                |
|---|--------------------------------|
| <b>Dielectric Withstanding Voltage:</b> | 500 VAC RMS                    |
| <b>Insulation Resistance</b>            | 1000 Megaohms minimum          |
| <b>Durability:</b>                      | 10,000 Cycles minimum          |
| <b>Contact Resistance:</b>              | 30 milliohms maximum (Initial) |
| <b>Contact Retention:</b>               | 4.9N (1.1 LBS)                 |



How to Order

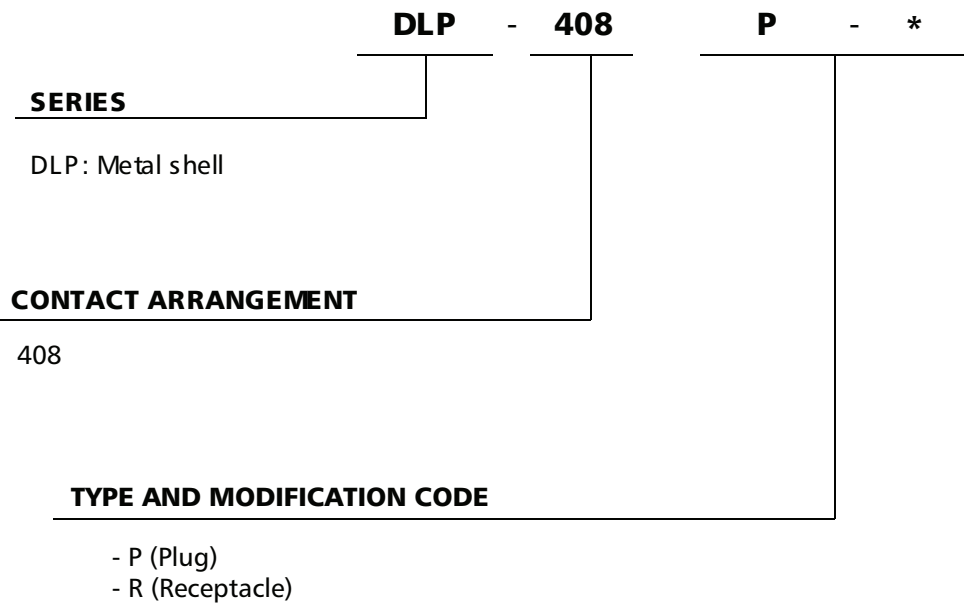
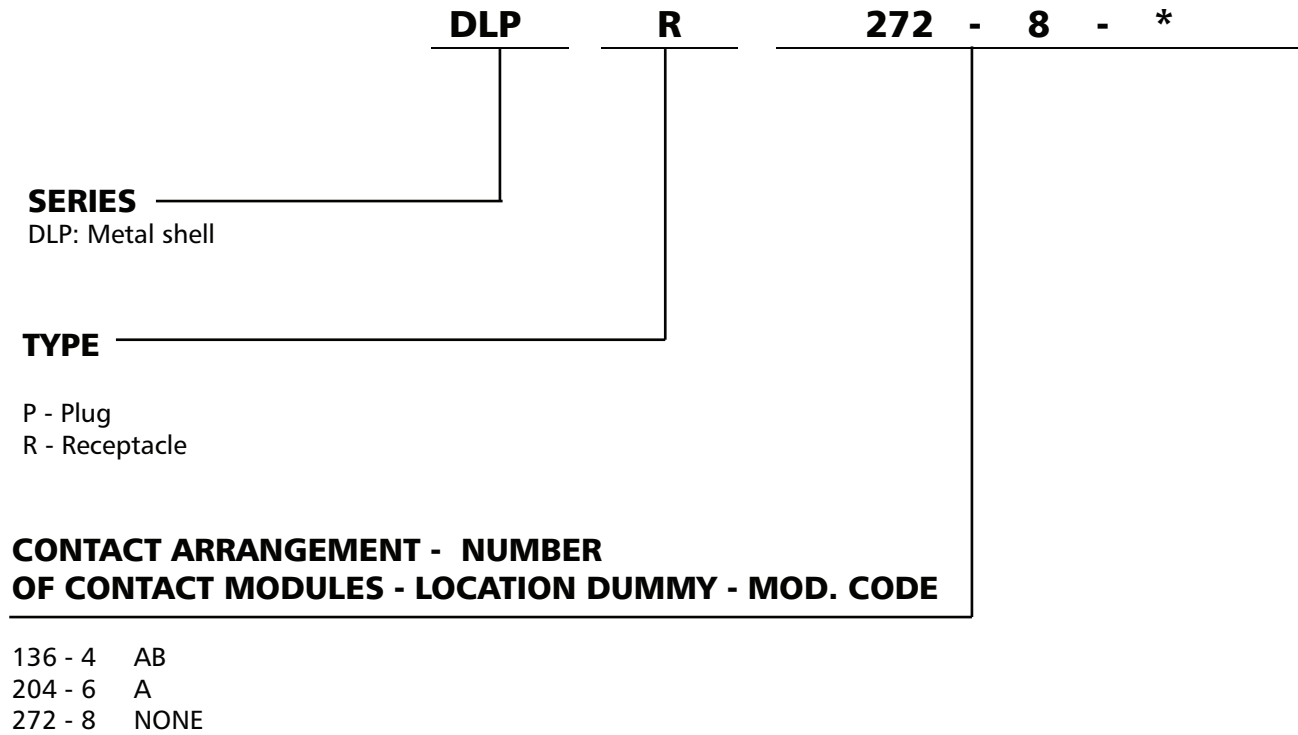

### Plug

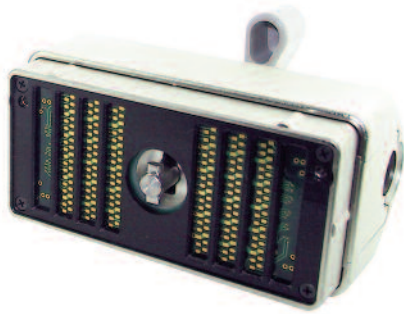

| Part Number | Nomenclature |
|-------------|--------------|
| 127050-0299 | DLP-P        |

| Part Number | Description              |
|-------------|--------------------------|
| 127000-2721 | DLP PWB Plate 8          |
| 127000-2721 | DLP PWB Plate 6          |
| M2.5 x 15mm | PWB Plate Mounting Screw |

Note: Flat head screw length dependent on customer backshell design

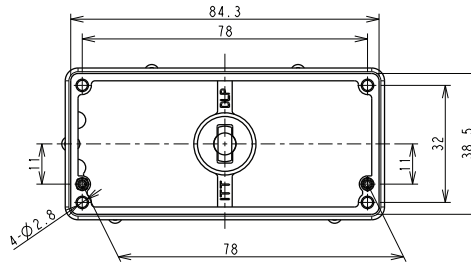
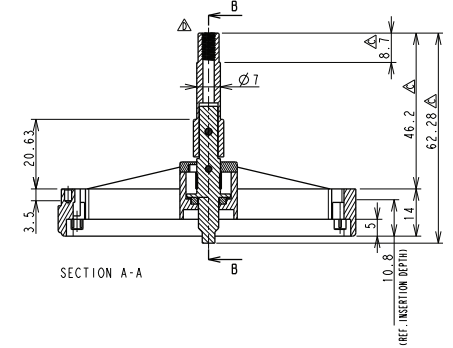
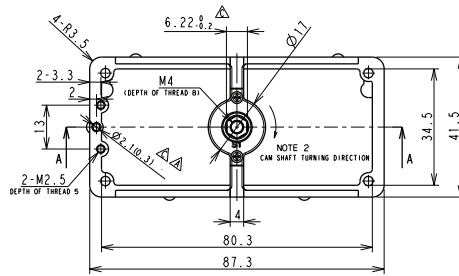

- Order Protective cover, sold separately. See page 45.
- For PC pad layout, see page 64.
- Not including backshell, handle, and screw.
- For contact cavity arrangements, see page 71.

### Receptacle

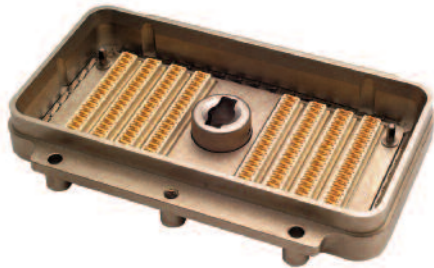

| Part Number | Nomenclature   |
|-------------|----------------|
| 127050-0444 | DLP-R204-6-A-F |
| 127050-0391 | DLP-R272-8-F   |

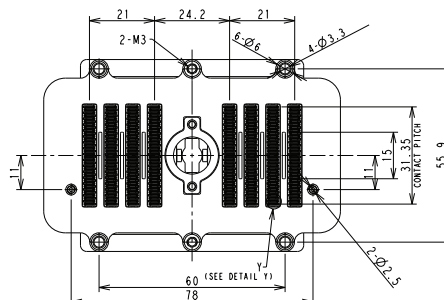
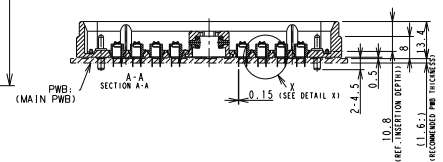
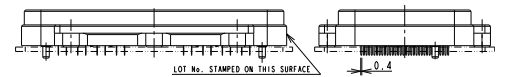
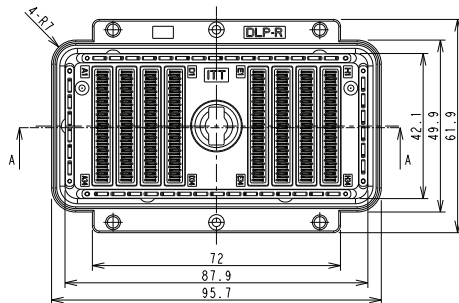

- For PC hole pattern, see page 64.
- For contact cavity arrangements, see page 71

### Plug

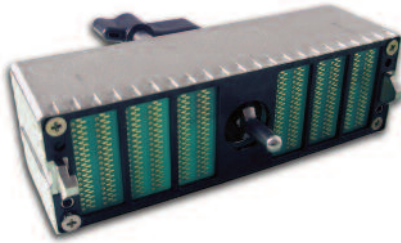

- Order Actuating Handle Kit, sold separately. See page 44.
- For Contact Cavity arrangements, see page 71.
- For PC pad layout, see page 65.
- PWB Protective Plate included. Screws sold separately.

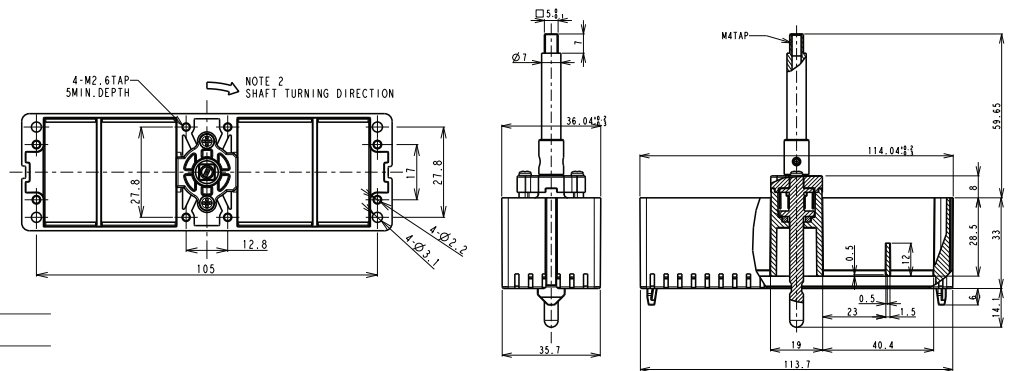

| Part Number | Nomenclature                 |
|-------------|------------------------------|
| 127050-0516 | DLP408P                      |
| 127059-0053 | PWB Plate Screws (center)*   |
| 127059-0054 | PWB Plate Screws (corners)** |

\* Two Center plate screws required.

\*\* Four Corner plate screws required.

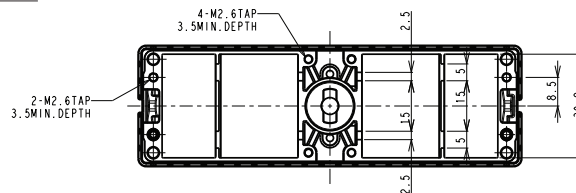

### Receptacle

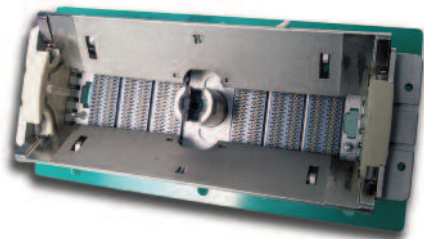

- For PC hole pattern, see page 65.
- For contact cavity arrangements, see page 71.

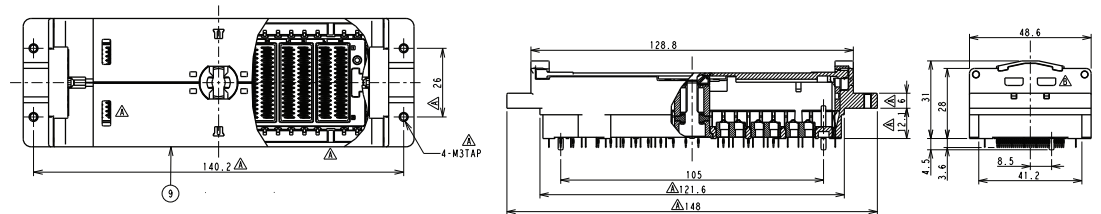

| Part Number | Nomenclature |
|-------------|--------------|
| 127050-0452 | DLP408R      |

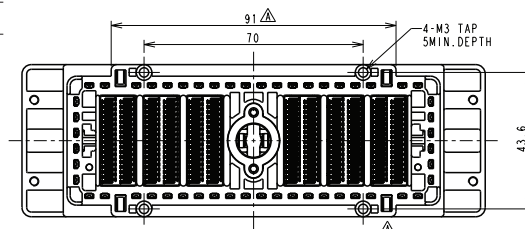

Dimensions shown in mm (inch)  
Specifications and dimensions subject to change

www.ittcannon.com



ITT Expands its DL Family of Connectors with the Miniature QLC Device to Meet Size, Reliability, and Mating Requirements for Portable Medical Equipment. Similar to the DL Series connectors, the QLC connector is highly reliable, easily assembled during harness and mating, and features a high pin count—up to 260 contacts in PC board-mount style. The QLC connector employs rugged nickel-plated aluminum housings and features a minimum rated life of 20,000 complete mating cycles with no performance loss. The interface of the QLC connector utilizes EMI springs and a shield-locking mechanism to ensure uniform mating pressure around the perimeter of the mated connector, creating an EMI/RFI shield.

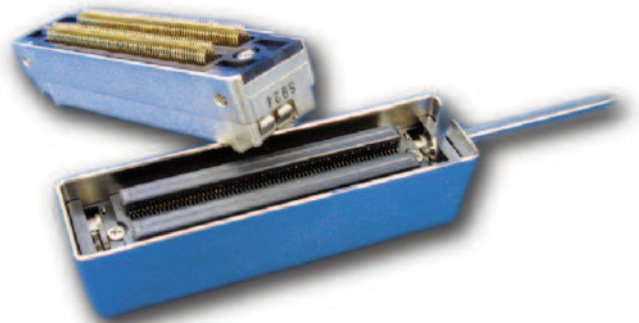

With technology advances for small portable imaging equipment, the demand for a smaller, higher pin count, shielded, reliable connector proves essential.

Consequently, ITT reduced the spacing from the standard DL to 0.8mm, thus reducing the overall size by more than 60% with the same number of contacts. The high pin count allows the engineer to utilize various grounding schemes to maintain signal integrity. The reduction in size, coupled with the superior shield design of the QLC, creates a sound interconnect choice for today’s portable market.

## Materials and Finishes

|                        |   |
|------------------------|---|
| <b>QLC Housing:</b>    | Zinc, Nickel plated   |
| <b>Contacts:</b>       | Copper Alloy, 40 μinches gold over nickel in mating area, gold flash over nickel in tail area |
| <b>Shaft Assembly:</b> | Stainless steel and plastic   |
| <b>Ground Spring:</b>  | Stainless steel   |
| <b>Insert Mold:</b>    | Plastic   |

## Electrical Data

|                             |   |
|-----------------------------|---|
| <b>No. of Contacts:</b>     | 260   |
| <b>Wire Size:</b>           | N/A   |
| <b>Contact Termination:</b> | Receptacle - DIP Solder to PCB<br>Plug - Solder to Daughter Board |

## Mechanical Data

|                         |                     |
|-------------------------|---------------------|
| <b>Actuation:</b>       | Roating Handle      |
| <b>Coupling:</b>        | Quad Latch          |
| <b>Polarization:</b>    | Polarizing Posts    |
| <b>Contact Spacing:</b> | 0.8mm               |
| <b>Shell Styles:</b>    | Plug and Receptacle |

## Performance Data

|   |   |
|---|---|
| <b>Dielectric Withstanding Voltage:</b> | 1000 VAC RMS                                      |
| <b>Insulation Resistance</b>            | 1000 Megaohms minimum                             |
| <b>Durability:</b>                      | 20,000 Cycles maximum                             |
| <b>Contact Resistance:</b>              | 100 milliohms maximum (including bulk resistance) |
| <b>Contact Retention:</b>               | N/A   |



## Plug

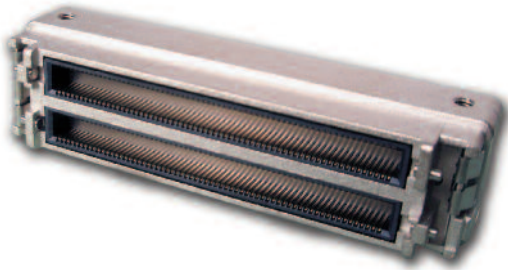

- Insulator retaining screw sold separately.
- For PC hole pattern, see page 65.

| Part Number | Nomenclature                           |
|-------------|--|
| 127050-0529 | QLC260P                                |
| 127059-0067 | Insulator Retaining Screw (2 required) |

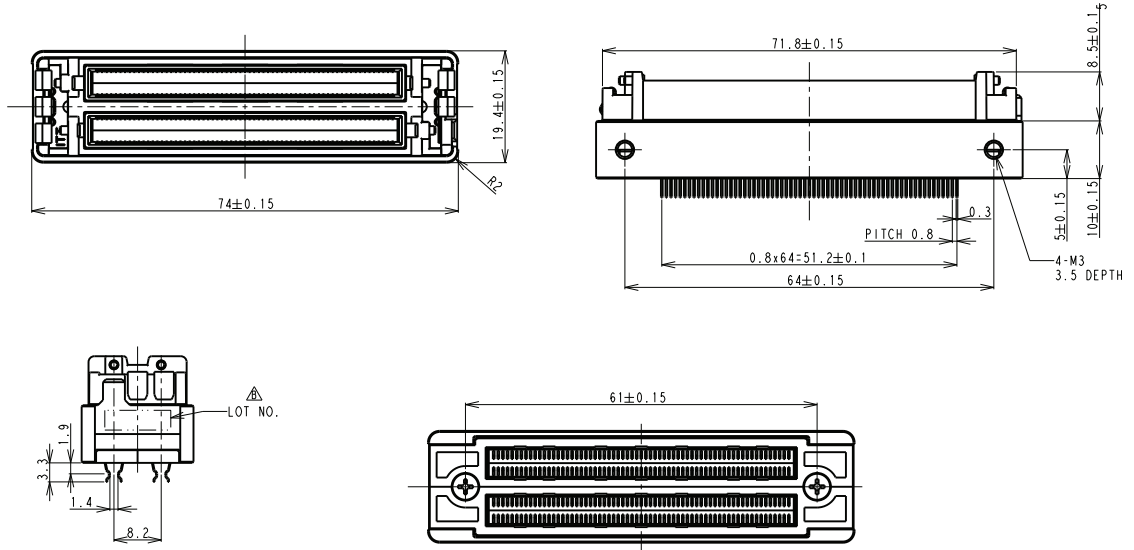

## Receptacle

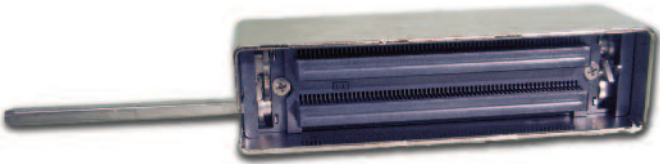

- Order actuating handle kit, sold separately. See page 44.
- For contact cavity arrangements, see page 71.
- For PC pad layout, see page 65.

| Part Number | Nomenclature |
|-------------|--------------|
| 127050-0530 | QLC260R      |

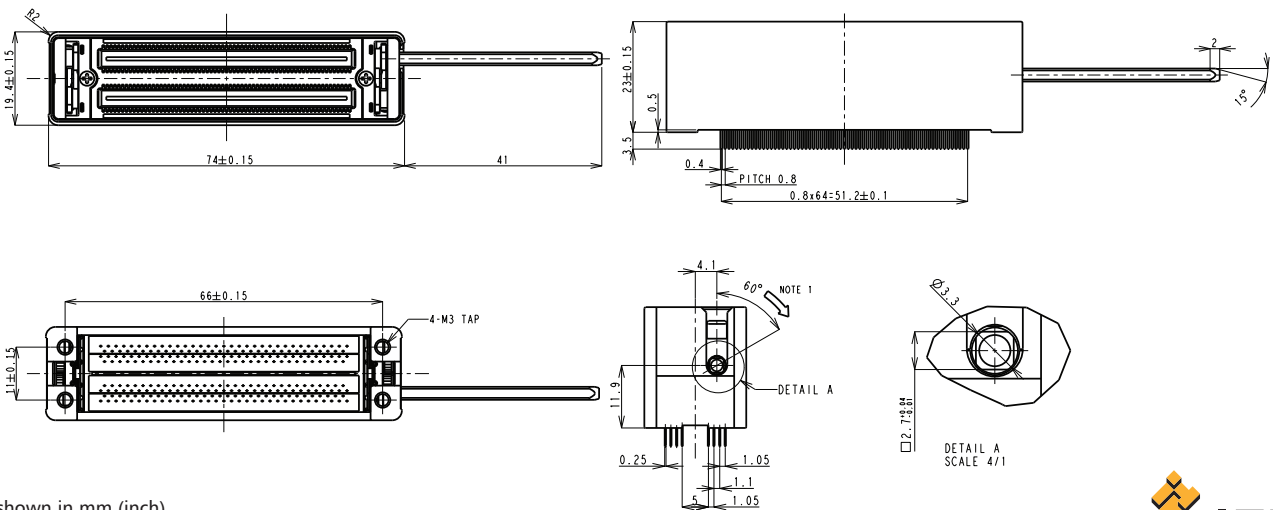

Dimensions shown in mm (inch)  
 Specifications and dimensions subject to change  
[www.ittcannon.com](http://www.ittcannon.com)



Cannon offers a wide selection of accessories that allow the design engineers to configure the product for their exact needs. The accessories range from the simple actuating handle to junction and backshells, as well as polarizing posts and protective covers for the contacts.

Actuating handles are the same for the DL1/2/3 and DLM1/2/3 series. The DL5/DLM5 and DLM6 series have specific handles. Handles are sold separately since many applications require the connector to be attached or removed only by an authorized technician.

Plastic junction shells are available for the DL1/2/3 series for encasement of the crimp contacts after complete installation into the connector. These shells also make it possible for the DL to be used as a cable-to-cable mating connector as they can be used both on the plug and the receptacle. The DL1/2/3 plastic junction shells have optional secondary cable entry capability by removing the molding in the cable entry plugs. Cable clamp kits are available to affix the cable to the second entry. This second entry option is very useful in applications where the large wire sizes make the cable diameter too large to be handled from a single entry port.

Metal Backshells are available for the entire DL/DLM series. The metal backshells are constructed from die cast aluminum with a nickel plating to facilitate in EMI/RFI shielding of the connector systems. Shielding has become a driving force because of the ever increasing stringent EMI/RFI regulations



Polarizing posts are available to offer a keying feature for both the DL and DLM connectors. The polarizing posts can be installed in specific orientation so that plugs of the same size connectors can only be mated in pre-determined receptacles. This feature offers the designer the ability to fool-proof the attachment possibilities to protect accidental damage to the system. Protective covers of plastic and anti-static rubber are available to

offer contact protection from physical damage or dust. Since the DL series has a high density of contacts in an exposed area, these covers are very useful for many applications. For example, where systems have multiple connectors, or when the connections are often left unattached, or when the system parts are put into storage.

## Accessory Selection Guide

| Connector Series | Actuating Handles<br>see page | Protective Covers  |                     | Metal Shell EMI/RFI Shielding<br>see page | Plastic Junction Shell<br>see page | Cable Clamps<br>see page | Metal Backshell<br>see page | Polarizing Posts<br>see page |
|------------------|-------------------------------|--------------------|---------------------|---|------------------------------------|--------------------------|-----------------------------|------------------------------|
|                  |                               | Rubber<br>see page | Plastic<br>see page |   |                                    |                          |                             |                              |
| <b>DL1-156</b>   |                               |                    |                     | -   |                                    |                          |                             |                              |
| <b>DL2-96</b>    |                               |                    |                     | -   |                                    |                          |                             |                              |
| <b>DL3-60</b>    |                               |                    |                     | -   |                                    |                          |                             |                              |
| <b>DL4-624</b>   | included                      |                    | -                   | -   | -                                  | -                        | -                           | -                            |
| <b>DL4-1248</b>  | included                      |                    | -                   | -   | -                                  | -                        | -                           | -                            |
| <b>DL4-2496</b>  | included                      |                    | -                   | -   | -                                  | -                        | -                           | -                            |
| <b>DL5-260</b>   |                               | -                  | -                   | -   | -                                  | -                        |                             |                              |
| <b>DLM1-256</b>  |                               |                    |                     | -   |                                    |                          |                             |                              |
| <b>DLM2-86</b>   |                               |                    |                     | -   |                                    |                          |                             |                              |
| <b>DLM3-60</b>   |                               |                    |                     | -   |                                    |                          |                             |                              |
| <b>DLM5-260</b>  |                               | -                  | -                   | -   | -                                  | -                        |                             |                              |
| <b>DLM6-360</b>  |                               | -                  | -                   | -   | -                                  | -                        |                             |                              |
| <b>DLD1-156</b>  | -                             | -                  | -                   | -   | -                                  | -                        | -                           | -                            |
| <b>DLD2-96</b>   | -                             | -                  | -                   | -   | -                                  | -                        | -                           | -                            |

Compatible  
- Not Compatible



Dimensions shown in mm (inch)  
Specifications and dimensions subject to

[www.ittcannon.com](http://www.ittcannon.com)



### Product Features

- Stainless steel cable clamps
- Thermoplastic UL 94V-1 rated
- Straight 90 or 45 cable entry
- Accommodates up to 22,22 (.875) cable
- For use with crimp contact connectors
- Knockout plug provides alternate second entry
- Complete with 4 attaching screws and nuts
- Complete with one cable clamp kit

### Junction Shell Kit (Straight or 90° Mounting)



#### DL1 / DLM1

| Description    | Part Number         | A                        | B                       | C                       | D                       | E                       | F                       | G                       | H                       | I                       | Max Cable Entry  |
|----------------|---------------------|--------------------------|-------------------------|-------------------------|-------------------------|-------------------------|-------------------------|-------------------------|-------------------------|-------------------------|------------------|
| <b>DL1-J/S</b> | <b>249-1950-000</b> | 110,74<br>(4.360)<br>MAX | 62,36<br>(2.455)<br>MAX | 68,58<br>(2.700)<br>MAX | 86,36<br>(3.400)<br>MAX | 43,94<br>(1.730)<br>MAX | 57,78<br>(2.275)<br>MAX | 63,50<br>(2.500)<br>MAX | 27,69<br>(1.090)<br>MAX | 50,44<br>(1.988)<br>MAX | 22,23<br>(0.875) |

Note: Single Piece Shell

#### DL2 / DLM2

#### DL3 / DLM3

| Description      | Part Number         | A                       | B                       | C                       | D                       | E                       | F                       | G                       | H                       | I                       | Max Cable Entry  |
|------------------|---------------------|-------------------------|-------------------------|-------------------------|-------------------------|-------------------------|-------------------------|-------------------------|-------------------------|-------------------------|------------------|
| <b>DL2-J/S</b>   | <b>249-1985-000</b> | 68,83<br>(2.710)<br>MAX | 46,81<br>(1.843)<br>MAX | 52,45<br>(2.065)<br>MAX | 71,04<br>(2.797)<br>MAX | 30,05<br>(1.183)<br>MAX | 36,45<br>(1.435)<br>MAX | 39,29<br>(2.500)<br>MAX | 31,75<br>(1.547)<br>MAX | 44,04<br>(1.250)<br>MAX | 14,20<br>(0.560) |
| <b>DL2-2-J/S</b> | <b>249-2238-000</b> | 68,83<br>(2.710)<br>MAX | 46,81<br>(1.843)<br>MAX | 52,45<br>(2.065)<br>MAX | 71,04<br>(2.797)<br>MAX | 30,05<br>(1.183)<br>MAX | 36,45<br>(1.435)<br>MAX | 39,29<br>(2.500)<br>MAX | 31,75<br>(1.547)<br>MAX | 44,04<br>(1.250)<br>MAX | 15,90<br>(0.625) |
| <b>DL2-4-J/S</b> | <b>249-2238-001</b> | 68,83<br>(2.710)<br>MAX | 46,81<br>(1.843)<br>MAX | 52,45<br>(2.065)<br>MAX | 71,04<br>(2.797)<br>MAX | 30,05<br>(1.183)<br>MAX | 36,45<br>(1.435)<br>MAX | 39,29<br>(2.500)<br>MAX | 31,75<br>(1.547)<br>MAX | 44,04<br>(1.250)<br>MAX | 22,23<br>(0.875) |
| <b>DL2-3-J/S</b> | <b>249-2060-000</b> | 68,83<br>(2.710)<br>MAX | 46,81<br>(1.843)<br>MAX | 52,45<br>(2.065)<br>MAX | 71,04<br>(2.797)<br>MAX | 30,05<br>(1.183)<br>MAX | 36,45<br>(1.435)<br>MAX | 39,29<br>(2.500)<br>MAX | 31,75<br>(1.547)<br>MAX | 44,04<br>(1.250)<br>MAX | 14,20<br>(0.560) |
| <b>DL3-3-J/S</b> | <b>249-2237-000</b> | 68,83<br>(2.710)<br>MAX | 46,81<br>(1.843)<br>MAX | 52,45<br>(2.065)<br>MAX | 71,04<br>(2.797)<br>MAX | 30,05<br>(1.183)<br>MAX | 36,45<br>(1.435)<br>MAX | 39,29<br>(2.500)<br>MAX | 31,75<br>(1.547)<br>MAX | 44,04<br>(1.250)<br>MAX | 15,90<br>(0.625) |
| <b>DL3-4-J/S</b> | <b>249-2237-001</b> | 68,83<br>(2.710)<br>MAX | 46,81<br>(1.843)<br>MAX | 52,45<br>(2.065)<br>MAX | 71,04<br>(2.797)<br>MAX | 30,05<br>(1.183)<br>MAX | 36,45<br>(1.435)<br>MAX | 39,29<br>(2.500)<br>MAX | 31,75<br>(1.547)<br>MAX | 44,04<br>(1.250)<br>MAX | 22,23<br>(0.875) |

Note: Two Piece Shell

### Junction Shell Kit (45° Mounting)



#### DL2 / DLM2

#### DL3 / DLM3

| Description      | Part Number         | A                       | B                       | C                       | D                       | E                       | F                       | G                       | H                       | I                       | Max Cable Entry  |
|------------------|---------------------|-------------------------|-------------------------|-------------------------|-------------------------|-------------------------|-------------------------|-------------------------|-------------------------|-------------------------|------------------|
| <b>DL2-1-J/S</b> | <b>249-1985-001</b> | 68,83<br>(2.710)<br>MAX | 46,81<br>(1.843)<br>MAX | 52,45<br>(2.065)<br>MAX | 71,04<br>(2.797)<br>MAX | 30,05<br>(1.183)<br>MAX | 36,45<br>(1.435)<br>MAX | 39,29<br>(2.500)<br>MAX | 31,75<br>(1.547)<br>MAX | 44,04<br>(1.250)<br>MAX | 15,90<br>(0.625) |
| <b>DL3-2-J/S</b> | <b>249-2060-001</b> | 68,83<br>(2.710)<br>MAX | 46,81<br>(1.843)<br>MAX | 52,45<br>(2.065)<br>MAX | 71,04<br>(2.797)<br>MAX | 30,05<br>(1.183)<br>MAX | 36,45<br>(1.435)<br>MAX | 39,29<br>(2.500)<br>MAX | 31,75<br>(1.547)<br>MAX | 44,04<br>(1.250)<br>MAX | 15,90<br>(0.625) |

Note: Two Piece Shell

Dimensions shown in mm (inch)

Specifications and dimensions subject to change

**Cable Clamp Kit for optional second entry (Straight or 90° Mounting)**

**DL1 / DL2 / DL3**

| Description   | Part Number  | Max Cable Entry  | Mounting        |
|---------------|--------------|------------------|-----------------|
| DL1-C/C       | 218-0179-000 | 22,23<br>(0.875) | Straight or 90° |
| DL1-C/C (1)   | 218-0180-000 | 14,20<br>(0.680) | Straight or 90° |
| DL2-2-C/C (1) | 218-0180-001 | 15,90<br>(0.625) | Straight or 90° |
| DL2-3-C/C (1) | 218-0200-000 | 22,23<br>(0.875) | Straight or 90° |



**Cable Clamp Kit for optional second entry (45° Mounting)**

**DL2**

| Description   | Part Number  | Max Cable Entry  | Mounting |
|---------------|--------------|------------------|----------|
| DL2-1-C/C (1) | 218-0181-000 | 15,90<br>(0.625) | 45°      |

Note: (1) Also suitable for DL3 Connectors



## Standard Materials and Finishes

|                  |                                      |
|------------------|--------------------------------------|
| <b>Shell:</b>    | Acrylic paint over die cast aluminum |
| <b>Hardware:</b> | Stainless Steel                      |

## Two Piece Shell Design (Straight or 90° Mounting)

**DL2 / DLM2**  
**DL3 / DLM3**

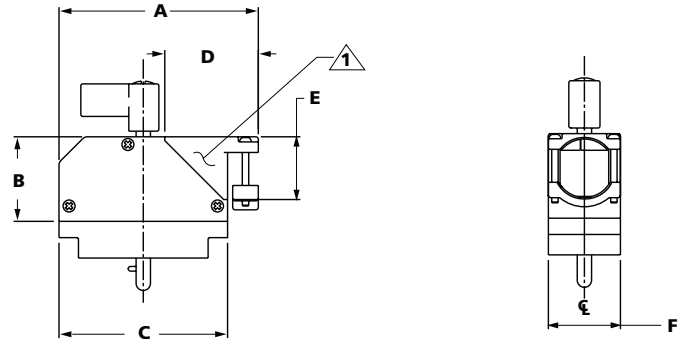

⚠ Wire hood may be installed in two positions. 90° cable entry as shown or straight entry by rotating wire hood.

| Used On               | Part Number         | A              | B              | C              | D              | E             | F              | Max Cable Entry  |
|-----------------------|---------------------|----------------|----------------|----------------|----------------|---------------|----------------|------------------|
| <b>DL2 / DLM2 (1)</b> | <b>249-4517-000</b> | 77,8<br>(3.06) | 33,0<br>(1.30) | 65,8<br>(2.59) | 36,3<br>(1.43) | 24,5<br>(.96) | 28.1<br>(1.11) | 19,05<br>(0.750) |
| <b>DL3 / DLM3 (1)</b> | <b>249-4518-000</b> | 77,8<br>(3.06) | 33,0<br>(1.30) | 65,8<br>(2.59) | 36,3<br>(1.43) | 24,5<br>(.96) | 28.1<br>(1.11) | 19,05<br>(0.750) |

Note: Kit consists of 2 shells, 9 screws, 1 wire hood, 1 wire clamp, 1 lock/open indication seal.

## One Piece Shell Design (Straight or 90° Mounting)

**DL1/DLM1**  
**DL5/DLM5**  
**DLM6**

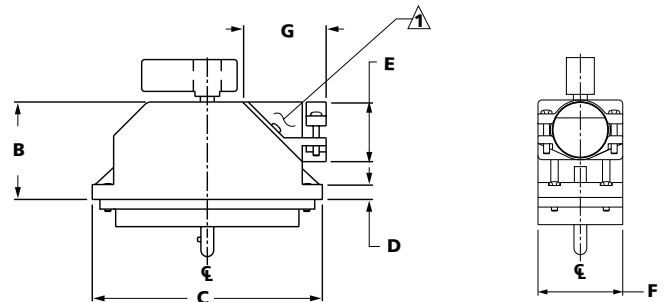
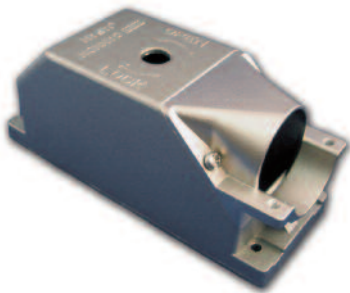

⚠ Wire hood may be installed in two positions. 90° cable entry as shown or straight entry by rotating wire hood.

| Used On              | Part Number         | A               | B              | C               | D             | E               | F               | Max Cable Entry  |
|----------------------|---------------------|-----------------|----------------|-----------------|---------------|-----------------|-----------------|------------------|
| <b>DL1/ DLM1 (2)</b> | <b>249-4520-000</b> | 123,4<br>(4,86) | 48,6<br>(1.91) | 111,4<br>(4.38) | N/A           | 24,0<br>(0.945) | 28,12<br>(1.11) | 19,05<br>(0.750) |
| <b>DL5/ DLM5 (3)</b> | <b>249-4501-000</b> | N/A             | 49,0<br>(1.93) | 115,8<br>(4.56) | 7,6<br>(0,30) | 30,0<br>(1.18)  | 42,6<br>(1.68)  | 22,3<br>(0.875)  |
| <b>DL6/ DLM6 (3)</b> | <b>249-4515-000</b> | N/A             | 63,0<br>(2.48) | 125,0<br>(4.92) | 7,6<br>(0,30) | 30,0<br>(1.18)  | 42,6<br>(1.68)  | 28,00<br>(1.102) |

Notes: (2) Kit consists of 2 shells, 10 screws, 1 wire hood, 1 wire clamp, 1 lock/open indication seal.

(3) Kit consists of 1 shell, 8 screws, 1 wire hood, 1 wire clamp, 4 nuts.

Dimensions shown in mm (inch)

Specifications and dimensions subject to change

www.ittcannon.com

### Product Features

- Provides a convenient method of actuating the contacts and cam for locking the connector.
- Kit provides actuating handle and attaching screw.
- Pointer on handle denotes "locked" and "open" positions.

### Materials and Finishes

**Handle:** Glass filled thermoplastic

**DL1 / DL2 / DL3  
DLM1 / DLM2 / DLM3**



**Part Number: 204-0016-000**

**DL5  
DLM5  
DLP408**



**Part Number: 204-4501-000**

**DLM6**



**Part Number: 204-4500-000**

**QLC**



**Part Number: 127059-0069**

Note: For DLP 272 Handle, please consult factory for more information.

### Protective Covers

#### Product Features

- Fits snugly over mating faces
- Prevents foreign matter from permeating contact cavities

#### Protective Covers - Rubber

##### Materials and Finishes

**Cover:** Anti-static synthetic rubber

#### DL / DLM Receptacle



| Cover for | Part Number  |
|-----------|--------------|
| DL1-156R  | 039-0243-000 |
| DL2-96R   | 039-0245-000 |
| DL3-60R   | 039-0247-000 |
| DL4-624R  | 039-0240-000 |

#### DL / DLM Plug



| Cover for | Part Number  |
|-----------|--------------|
| DL1-156P  | 039-0242-000 |
| DL2-96P   | 039-0244-000 |
| DL3-60P   | 039-0246-000 |
| DL4-624P  | 039-0239-000 |

#### Protective Covers - Plastic

##### Materials and Finishes

**Cover:** Polyethylene

#### DL / DLM Plug



| Cover for | Part Number  |
|-----------|--------------|
| DL1-156P  | 025-0852-000 |
| DL2-96P   | 025-0857-000 |
| DL3-60P   | 025-0850-000 |

#### DL / DLM Receptacle



| Cover for | Part Number  |
|-----------|--------------|
| DL1-156R  | 025-4506-000 |
| DL2-96R   | 025-4505-000 |
| DL3-60R   | 025-4509-000 |
| DL5-260R  | 025-1218-000 |

Note: Must remove/cut secondary cap from DL5 cover

#### DLP 272



| Nomenclature            | Part Number |
|-------------------------|-------------|
| DLP PWB Protect 6A/H    | 127000-2721 |
| DLP PWB Protect 8       | 127000-2720 |
| DLP Plug Dust Cap       | 127000-2719 |
| DLP Receptacle Dust Cap | 127000-2732 |

Dimensions shown in mm (inch)  
 Specifications and dimensions subject to change

### Center Mounting

#### Materials and Finishes

|               |                          |
|---------------|--------------------------|
| <b>Post:</b>  | Zinc, copper over nickel |
| <b>Screw:</b> | Stainless Steel          |

#### DL1 / DL2 DLM1 / DLM2



| Kit consists of                                | Part Number         |
|--|---------------------|
| 2 posts and 2 no. 2- 56 X3/16 fil. Head screws | <b>320-0021-005</b> |

### Corner Mounting

#### Materials and Finishes

|               |                 |
|---------------|-----------------|
| <b>Post:</b>  | Zinc, nickel    |
| <b>Screw:</b> | Stainless Steel |

#### DL1 / DL2 / DL3 DLM6



| Kit consists of             | Part Number         |
|-----------------------------|---------------------|
| 2 posts and 2 No. 4-40x9/32 | <b>320-0021-006</b> |

#### DLM1 / DLM2 / DLM3



| Kit consists of              | Part Number         |
|------------------------------|---------------------|
| 4 posts and 4 M2.5x10 screws | <b>320-4505-000</b> |

#### DL5 DLM5



| Kit consists of           | Part Number         |
|---------------------------|---------------------|
| 4 posts and 4 M3x8 screws | <b>320-4502-000</b> |

### Materials and Finishes

Shell: Steel, Nickel Finish

### Metal Shells (DL5 only)

#### Plug

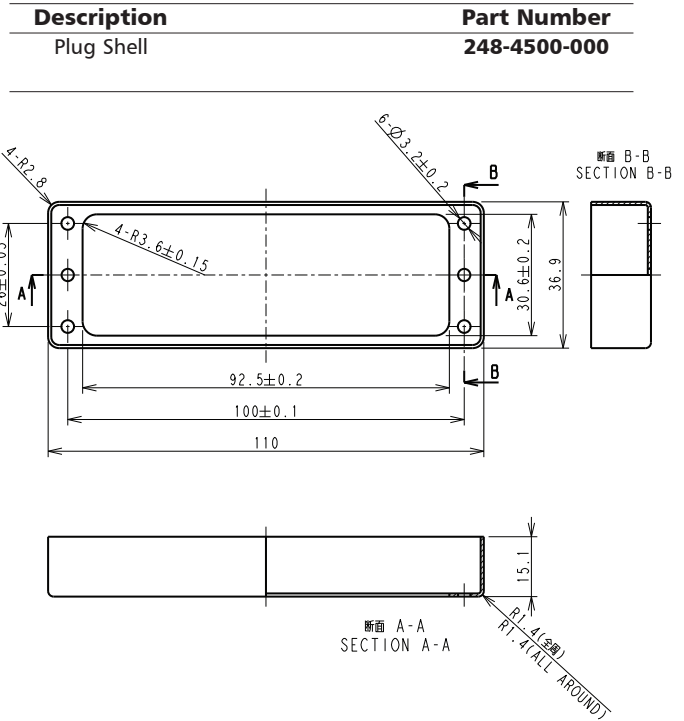

#### Receptacle

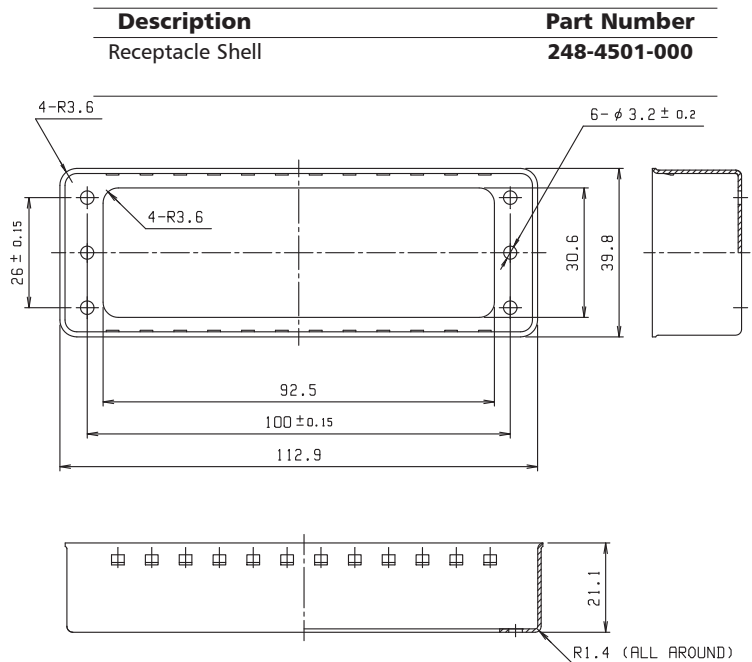

Dimensions shown in mm (inch)  
Specifications and dimensions subject to change

www.ittcannon.com



The Cannon DL Crimp and Buss contacts are available in addition to the factory installed Square Post/PCB mount version contacts. Crimp contacts are available loose only.

The Buss Contacts make the DL series capable of providing higher than 5 amps per line. The Buss contacts are pairs of contact lines which increase the amperage capability in increments of 10 amps up to 60 amps. The contacts have solder holes at the tail section for soldering #30-#18 AWG. The tail is also designed to accommodate a 1/8 crimp lug for wire sizes larger than #18.

The Crimp contacts are available in two plating types. The 20 mil gold hermaphroditic version which is the economical choice for applications requiring over 100 milliamps to 5 amps, and the 50 mil gold bump to flat version which offers the most versatile range of applications requirements from micro-amps to 5 amps.

The Bump to Flat version was developed specifically to handle “dry circuit” requirements where the signal amperage is not enough to ensure a clean contact point. The 50 mil gold Bump to Flat version is mandatory for applications with signals below 100 milliamps. The Bump contact is installed in the Plug and the Flat contact is installed in the receptacle. This combination increases the contact force and ensures that the wiping point becomes the current carrying point after mating. The 50 mil gold Bump to Flat version has become the standard for all modern applications where power and low voltage signals are combined into one connector.





### 1 Pair

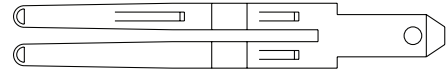
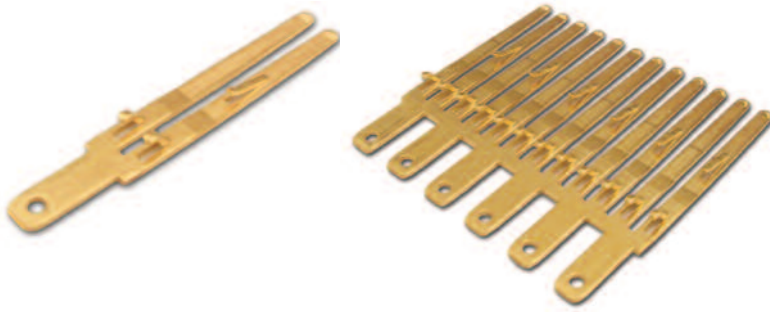

- Designed for power distribution of more than 5 amps.
- Accommodates #30-#18 AWG in hole 1,29-1,14 (.051-.045) for wire soldering.
- Accommodates 1/8 crimp lugs for larger wire sizes.

### Buss Contact

| Description | Part Number  |
|-------------|--------------|
| 1 Pair      | 030-7380-001 |
| 2 Pair      | 030-7380-002 |
| 3 Pair      | 030-7380-003 |
| 4 Pair      | 030-7380-004 |
| 5 Pair      | 030-7380-005 |
| 6 Pair      | 030-7380-006 |

**Material:** Copper Alloy

**Finish:** 20µ inch in mating area / gold flash on balance (terminating end)

Note: For more information on tools and assembly, see pages

### Wire Termination - Solder

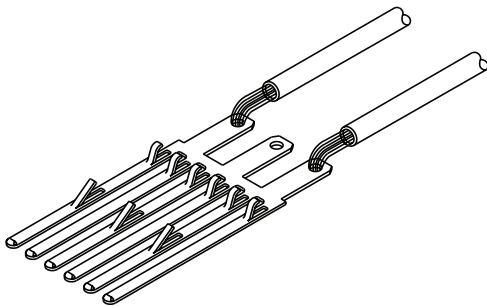

### Wire Termination - Crimp Lug

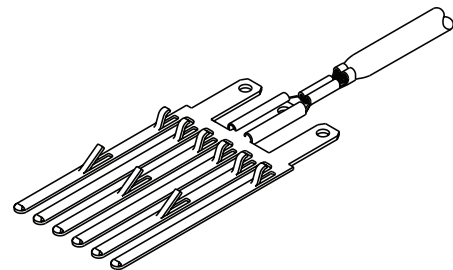

Note: Contacts must be installed in the vertical position.

### 50 inch Gold Contacts

- Recommended for all applications
- Offer the broadest amperage range
- Mandatory for low current applications, less than 100 milliamps.

#### Materials and Finishes

|                  |   |
|------------------|---|
| <b>Material:</b> | Copper Alloy  |
| <b>Finish:</b>   | 50 inch Gold over Nickel in mated area, Gold flash on balance (terminating end) |

#### Plug (Bump)

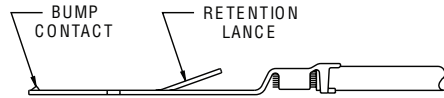

| Wire Type          | Loose Part Number   | Reeled Part Number |
|--------------------|---------------------|--------------------|
| 28 thru 32 AWG     | <b>030-2416-003</b> | <b>110238-0482</b> |
| 24 thru 26 AWG     | <b>030-2410-003</b> | <b>110238-0480</b> |
| 20 thru 22 AWG     | <b>030-2409-003</b> | <b>110238-0479</b> |
| 18 thru 20 AWG (1) | <b>030-2415-003</b> | <b>110238-0481</b> |

Note: Contact can be used in both plug and receptacle for applications above 100 MA.

#### Receptacle (Flat)



| Wire Type          | Loose Part Number   | Reeled Part Number |
|--------------------|---------------------|--------------------|
| 28 thru 32 AWG     | <b>030-2494-001</b> | <b>110238-0486</b> |
| 24 thru 26 AWG     | <b>030-2492-001</b> | <b>110238-0484</b> |
| 20 thru 22 AWG     | <b>030-2491-001</b> | <b>110238-0483</b> |
| 18 thru 20 AWG (1) | <b>030-2493-001</b> | <b>110238-0485</b> |

Caution: Flat contacts can only be used in the receptacle

### 20 inch Gold Contacts

#### Materials and Finishes

|                  |  |
|------------------|--|
| <b>Material:</b> | Copper Alloy   |
| <b>Finish:</b>   | 20 inch Gold over Nickel, in mated area, Gold flash on balance (terminating end) |

#### Plug and Receptacle (Bump) (3)

| Wire Type          | Loose Part Number   | Reeled Part Number |
|--------------------|---------------------|--------------------|
| 36 thru 38 AWG (2) | <b>127000-2207</b>  | <b>127000-1271</b> |
| 28 thru 32 AWG     | <b>030-2416-001</b> | <b>110238-1030</b> |
| 24 thru 26 AWG     | <b>030-2415-001</b> | <b>110238-1029</b> |
| 20 thru 22 AWG     | <b>030-2410-001</b> | <b>110238-1028</b> |
| 18 thru 20 AWG     | <b>030-2409-001</b> | <b>110238-1027</b> |

- Note: (1) Non insulation support  
 (2) 20 inch gold in mating area/Gold flash on balance (terminating end), RoHS compliant, sold in lots of 100 pieces.  
 (3) 20 inch gold Bump contact are used for both Plug and Receptacle

A key feature of the Cannon DL connector series is easy contact termination, both in the field and in high-volume production. An ergonomically designed hand crimp tool is available for the low volume (loose contact) applications and will accommodate two different crimp contact sizes. To reduce overall costs, the crimp jaws are replaceable.

Automatic crimp and strip/crimp machines are available for high volume applications requiring a large number of crimps (50,000 crimps per year or more). These machines are leased to customers to eliminate the need for heavy investment. They also improve productivity for large pin count applications.

DL Crimp contacts are designed to be hand installed into the connector, no tooling is needed for the insertion process. Extraction tools are available for the removal of Crimp contacts for easy repair even in field applications. Extraction tools are also available for the Buss contacts, as well as the factory installed Square Post contacts.

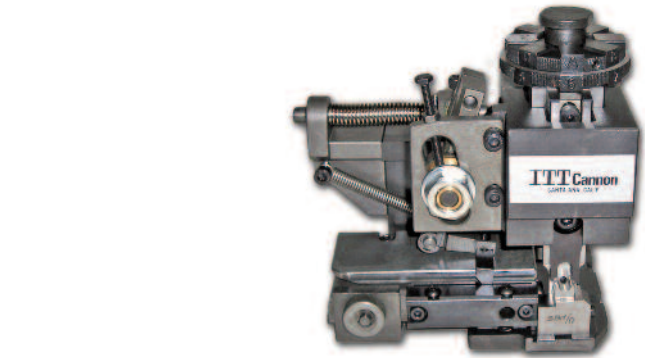

## Hand Crimp Tool



Hand Crimp Tool with Replaceable Jaw Set

| Hand Tool | Description | Part Number |
|-----------|-------------|-------------|
| 1         | CHDLT 28-32 | 112108-0002 |
| 2         | CHDLT 20-26 | 112108-0001 |
| 3         | CHDLT 18-20 | 112108-0000 |

## Crimp Tensile Strength

Crimp tensile strength is a measure of how hard a wire can be pulled without breaking or separating from the contact. This is the best way to verify that the wire is properly terminated to the contact. Periodic crimp tensile measurements are recommended to insure the integrity of the crimp. The table below contains the appropriate values for DL crimp contacts.

### Wire Trim Dimension



| Wire Size (AWG)         | 32          | 30          | 28          | 26          | 24          | 22          | 20          | 18          |
|-------------------------|-------------|-------------|-------------|-------------|-------------|-------------|-------------|-------------|
| Tensile Min. (lbs)      | 1           | 1.5         | 3           | 7           | 10          | 15          | 19          | 30          |
| Wire Trim Dimension "A" | 3,30 (.130) | 3,30 (.130) | 3,30 (.130) | 3,30 (.130) | 3,30 (.130) | 3,30 (.130) | 4,06 (.160) | 4,06 (.160) |
| Insulation Dia. Max     | 1,35 (.053) | 1,35 (.053) | 1,35 (.053) | 1,65 (.065) | 1,65 (.065) | 1,88 (.074) | 1,88 (.074) | 1,88 (.074) |

Dimensions shown in mm (inch)  
Specifications and dimensions subject to change

## Extraction Tool - Buss Contacts



### Extraction Tool for Buss Contact

| Description | Contacts | Part Number         |
|-------------|----------|---------------------|
| CET-DL3     | 1 pair   | <b>274-7029-003</b> |
| CET-DL4     | 2 pair   | <b>274-7029-004</b> |
| CET-DL4     | 3 pair   | <b>274-7029-004</b> |
| CET-DL5     | 4 pair   | <b>274-7029-005</b> |
| CET-DL6     | 5 pair   | <b>274-7029-006</b> |
| CET-DL6     | 6 pair   | <b>274-7029-006</b> |

## Extraction Tool - Crimp, Square Post, PC/RC Contacts

CET-DL10

CET-ECP

CET-ECP-1



| Description | Part Number         | Contact Type | PC Tail Extension |
|-------------|---------------------|--------------|-------------------|
| CET-DL10    | <b>274-7029-007</b> | Crimp        | -                 |
| CET-ECP     | <b>274-7045-000</b> | Wrap Post    | 15,37 (.605)      |
| CET-ECP-1   | <b>274-7045-001</b> | Square Post  | 7,11 (.280)       |

### Assembly Instructions for Crimp Contacts

#### Contact Insertion:

All crimp contacts inserted by hand. No tooling is required for either the plug or receptacle.

**Caution:** Do not force contacts into contact cavities. If contact encounters excessive resistance during installation remove and re-insert using a slight up and down motion. This will assure positive cavity alignment. *Do not* install contact if plug is in the *closed* or actuated position.

#### Plug:

Step 1. Prior to inserting contacts, turn the shaft counter-clockwise to its maximum *open* position.

Step 2. With the retention lance positioned away from the shaft, insert contacts from the rear of the contact plug.

#### Receptacle:

Step 1. With the retention lance positioned toward the shaft hole, insert contacts from the rear of the receptacle.

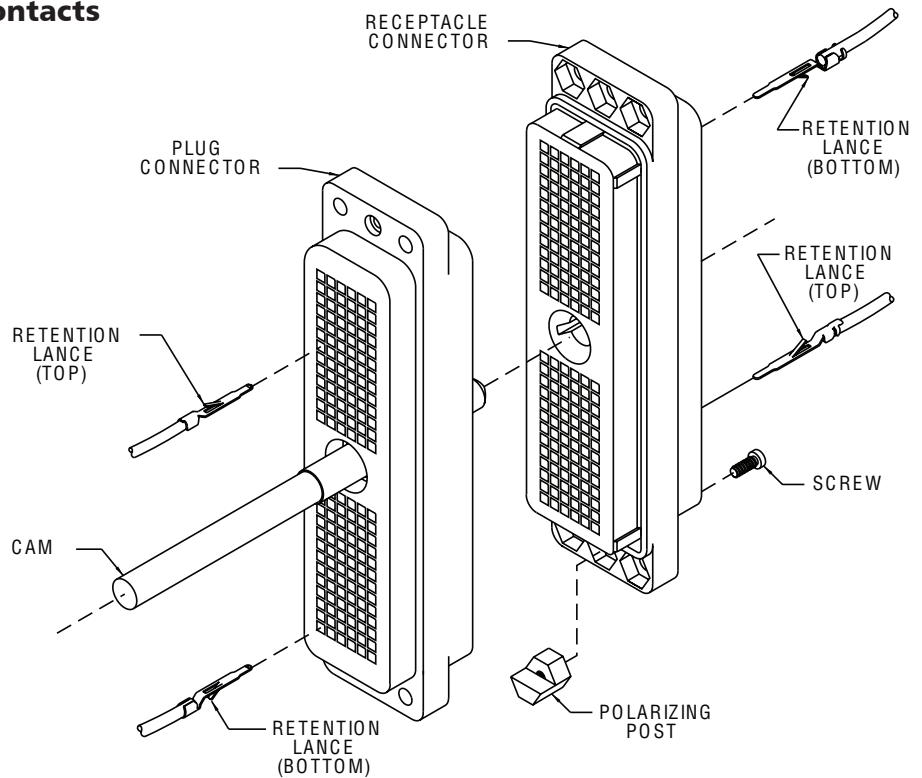

### Contact Removal for Crimp Contacts

#### Tool: CET-DL10



Release retention lance by inserting tip of extraction tool into cavity until it bottoms on insulator shoulder. Gently pull wire in direction of arrow, see illustration, to remove contact from insulator.

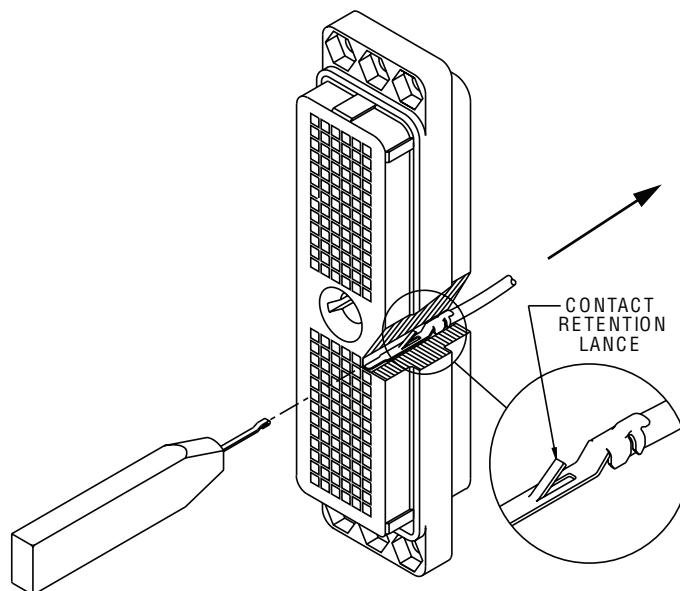

### Assembly Instructions for Buss Contacts

#### Contact Insertion:

All buss contacts are inserted by hand. No tooling is required for either the plug or receptacle.

**Caution:** Do not force contacts into contact cavities. If contact encounters excessive resistance during installation remove and re-insert using a slight up and down motion. This will assure positive cavity alignment. *Do not* install contact if plug is in the *closed* or actuated position.

#### Plug:

Step 1. Prior to inserting contacts, turn the shaft counter-clockwise to its maximum *open* position.

Step 2. With the retention lance positioned away from the shaft, insert contacts from the rear of the contact plug.

#### Receptacle:

Step 1. With the retention lance positioned toward the shaft hole, insert contacts from the rear of the receptacle.

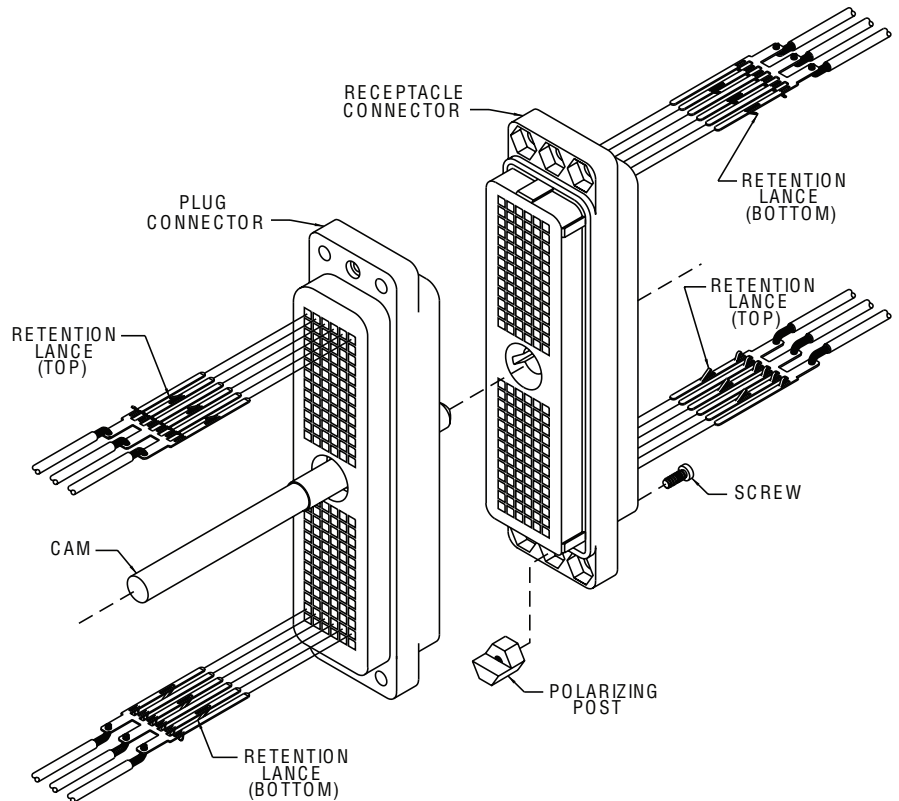

### Contact Removal for Buss Contacts

#### Tool: CET-DL3/4/5/6



Release retention lance by inserting tip of extraction tool into cavity until it bottoms on insulator shoulder. Gently remove buss contact in direction of arrow, see illustration, to remove contact from insulator.

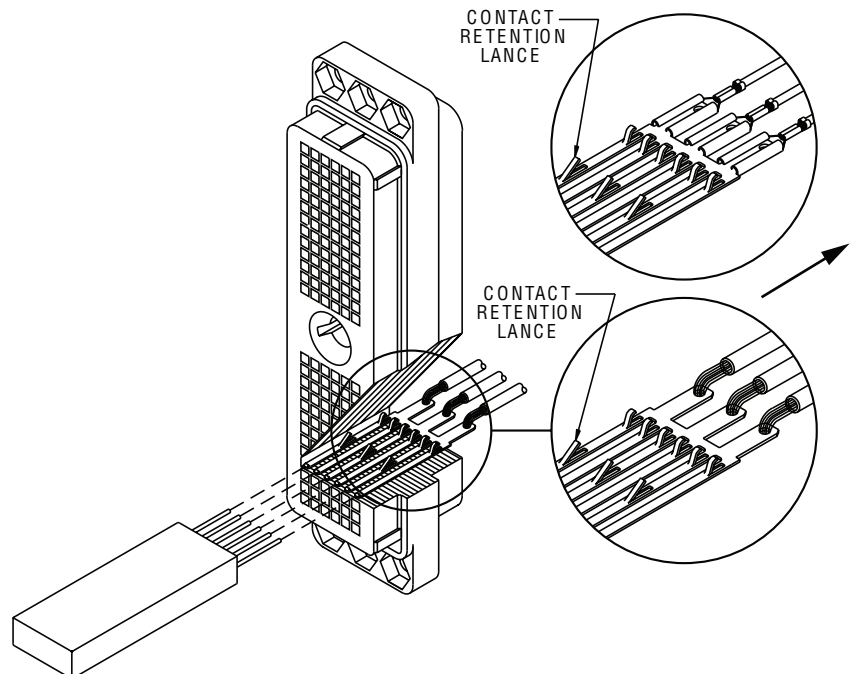

### Assembly Instructions for Square Post Contacts

#### Contact Insertion:

Square Post Contacts are factory installed but can be removed and replaced if damaged in service.

Step 1. Prior to inserting contacts, actuating handle must be in the maximum open position.

Step 2. Contacts are inserted from the insulator front face by hand and are seated and clicked in the cavity by pulling on the terminal post with flat nose plier, see Figure 1.



**Figure 1**

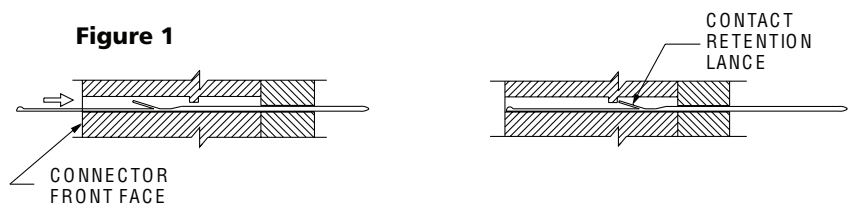

### Contact Removal for Square Post Contacts

#### Tool: CET-ECP and CET-ECP-1



Place tool over square post terminal and impact tool. Apply sufficient force to collapse retention lance and push contact out of insulator. This process destroys the retention lance

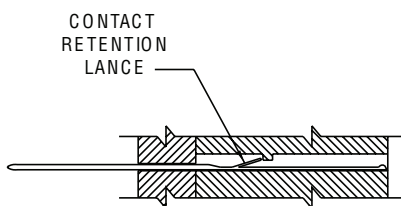
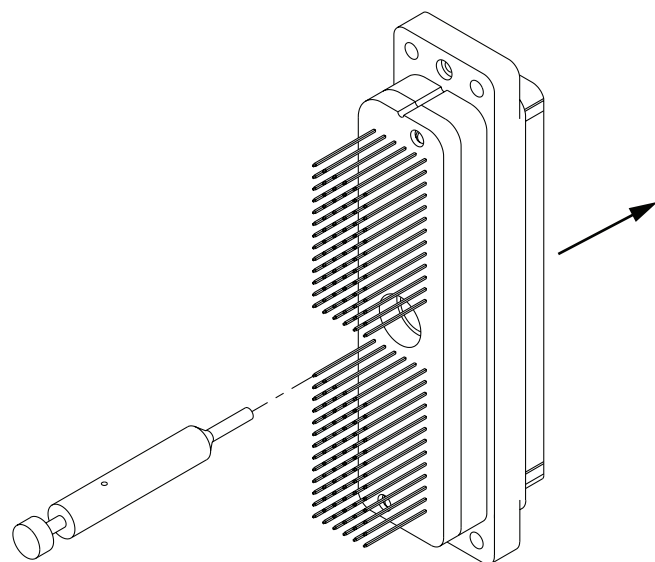

## Lease Automatic Tooling - North America\*

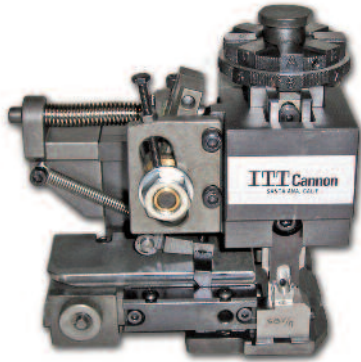

Mini Applicators are interchangeable modules that will fit into many standard crimping machines. They are available for all sizes of stamped and reeled contacts

| Wire Size AWG                | 18-20        | 20-22       | 24-36       | 28-32       |
|------------------------------|--------------|-------------|-------------|-------------|
| <b>20 inches Gold</b>        | 110238-0402* | 110238-0400 | 110238-0401 | 110238-0403 |
| <b>50 inches Gold (Bump)</b> | 110238-0481* | 110238-0479 | 110238-0480 | 110238-0482 |
| <b>50 inches Gold (Flat)</b> | 110238-0485* | 110238-0483 | 110238-0484 | 110238-0486 |

\* Without Insulation support

| Mini Applicator                                | DL-T 18-20      |                 | DL-T 20-22       |                  | DL-T 24-26      |                 | DL-T 28-32      |                 |                 |
|--|-----------------|-----------------|------------------|------------------|-----------------|-----------------|-----------------|-----------------|-----------------|
| <b>Applicator p/n</b>                          | 112211-0002     |                 | 112211-0003      |                  | 112211-0009     |                 | 112211-0010     |                 |                 |
| <b>Wire Size</b>                               | 18              | 20              | 20               | 22               | 24              | 26              | 28              | 30              | 32              |
| <b>Strip Length Reference</b>                  | 4.00<br>(0.160) | 4.00<br>(0.160) | 3.3<br>(0.130)   | 3.3<br>(0.130)   | 3.3<br>(0.130)  | 3.3<br>(0.130)  | 3.3<br>(0.130)  | 3.3<br>(0.130)  | 3.3<br>(0.130)  |
| <b>Conductor Crimp Width - Max</b>             | 1,80<br>(0.071) | 1,80<br>(0.071) | 1,710<br>(0.067) | 1,710<br>(0.067) | 1,5<br>(0.059)  | 1,5<br>(0.059)  | 1,5<br>(0.059)  | 1,5<br>(0.059)  | 1,5<br>(0.059)  |
| <b>Conductor Crimp Height +/- 0,03 (0.001)</b> | 1,52<br>(0.060) | 1,34<br>(0.053) | 1,25<br>(0.049)  | 1,22<br>(0.048)  | 1,04<br>(0.041) | 0,96<br>(0.038) | 0,84<br>(0.033) | 0,79<br>(0.031) | 0,74<br>(0.029) |
| <b>Insulation crimp Height - Max</b>           | N/A             | N/A             | 1,88<br>(0.074)  | 1,88<br>(0.074)  | 1,65<br>(0.065) | 1,65<br>(0.065) | 1,35<br>(0.053) | 1,35<br>(0.053) | 1,35<br>(0.053) |
| <b>Tensile Pull Minimum (Newtons)</b>          | 133 (30)        | 84 (19)         | 84 (19)          | 67 (15)          | 44 (10)         | 31 (7)          | 13 (3)          | 7 (1.5)         | 4 (1)           |

## ABT-620 UCCS



The ABT-620 Universal Cannon Crimper / Stripper is a pneumatic powered, microprocessor controlled machine. It is designed to semi-automatically strip insulation from stranded or single conductor electrical wire and attach a stamped and formed contact by crimping. The machine will accommodate 34 thru 12 AWG wire. Primary application of the machine is the termination of jacketed cable where the individual leads cannot be stripped by fully automated equipment. The ABT-620 UCCS operates automatically upon insertion of a wire or it can be switched over to a foot pedal operation as desired.

### **Machined Strip / Crimp Rate:**

1200+ per hour

### **Power Requirements:**

Electrical = 115 VAC, 60 Hz, 20A  
Pneumatic = 80 psi, 3 cu. ft per min.

\* For other geographical regions, contact Cannon for details.





## Lease or Buy Automatic Tooling - Europe

### TT Crimping Press

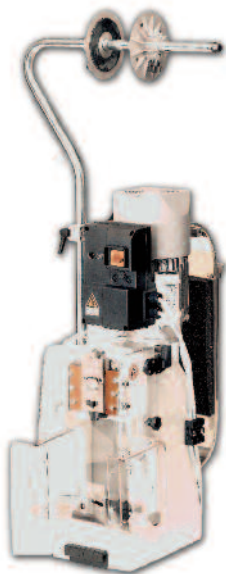

The TT Crimping Press is available either in semi-automatic (for bench-top use) configuration or in full automatic (integrated into a cut and strip machine) configuration. Very compact and light, its spheroidal cast iron, one-piece structure offers the highest rigidity for a very stable crimping height value. A proprietary safety cover (grants the operator a perfect view of the crimping zone while enjoying complete protection from any hazard). The semi-automatic configuration (for bench top use) always includes safety cover, reel arm, foot switch according to the international safety standard and CE regulation. Mini-applicators are available for all sizes of stamped and reeled contacts.

**Part Number: 121586-5225**

### Mini-Applicators - Europe

| Wire Size AWG                   | 18-20 | 20-22       | 24-26       | 28-32       |
|---------------------------------|-------|-------------|-------------|-------------|
| 20 $\square$ inches Gold        |       | 110238-0400 | 110238-0401 | 110238-0403 |
| 50 $\square$ inches Gold (Bump) | -     | 110238-0479 | 110238-0480 | 110238-0482 |
| 50 $\square$ inches Gold (Flat) | -     | 110238-0483 | 110238-0484 | 110238-0486 |

| Mini Applicator                         | DL-T 18-20      |                 | DL-T 20-22      |                  | DL-T 24-26      |                 | DL-T 28-32      |            |            |
|---|-----------------|-----------------|-----------------|------------------|-----------------|-----------------|-----------------|------------|------------|
| Applicator p/n                          | -               |                 | -               |                  | -               |                 | -               |            |            |
| Wire Size AWG<br>mm <sup>2</sup>        | 18<br>0,82      | 20<br>0,52      | 20<br>0,52      | 22<br>0,33       | 24<br>0,25      | 26<br>0,14      | 28<br>0,08      | 30<br>0,05 | 32<br>0,03 |
| Strip Length Reference                  | 4.00<br>(0.160) | 4.00<br>(0.160) | 3.30<br>(0.130) | 3.30<br>(0.130)  | 3.30<br>(0.130) | 3.30<br>(0.130) | 3.30<br>(0.130) | -          | -          |
| Conductor Crimp Width - Max             | 1,80<br>(0.071) | 1,80<br>(0.071) | 1,70<br>(0.067) | 1,700<br>(0.067) | 1,50<br>(0.059) | 1,50<br>(0.059) | 1,5<br>(0.059)  | -          | -          |
| Conductor Crimp Height +/- 0,03 (0.001) | 1,45<br>(0.057) | 1,35<br>(0.053) | 1,22<br>(0.048) | 1,14<br>(0.045)  | 1,07<br>(0.042) | 1,04<br>(0.041) | 0,90<br>(0.035) | -          | -          |
| Insulation Crimp Height - Max           | 0               | 0               | 1,88<br>(0.074) | 1,88<br>(0.074)  | 1,65<br>(0.065) | 1,65<br>(0.065) | 1,65<br>(0.065) | -          | -          |
| Tensile Pull Minimum (Newtons)          | 133             | 84              | 84              | 53               | 32              | 18              | 11              | -          | -          |

Note: All applicators are compatible with TT Crimping Press, #121586-5225. We advise all our customers to hold at least one set of consumable tooling (consisting of Conductor Crimp Blade, Insulation Crimp Blade, Combination Anvil, Shear Moving and Shear Fixed). Please consult factory to order consumable tooling.

## PCB Pad Layout

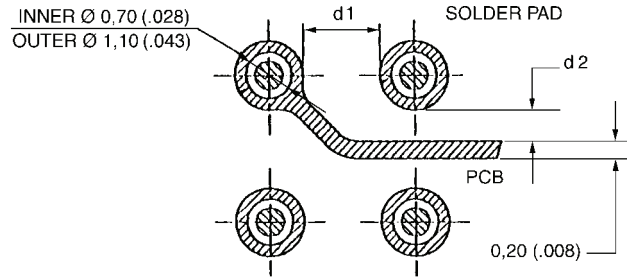
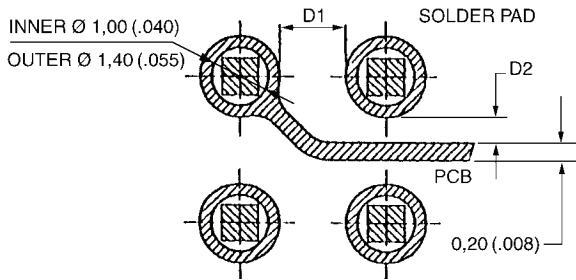
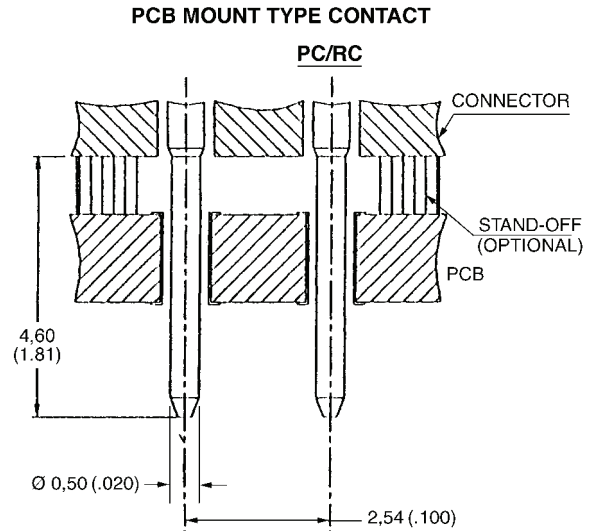
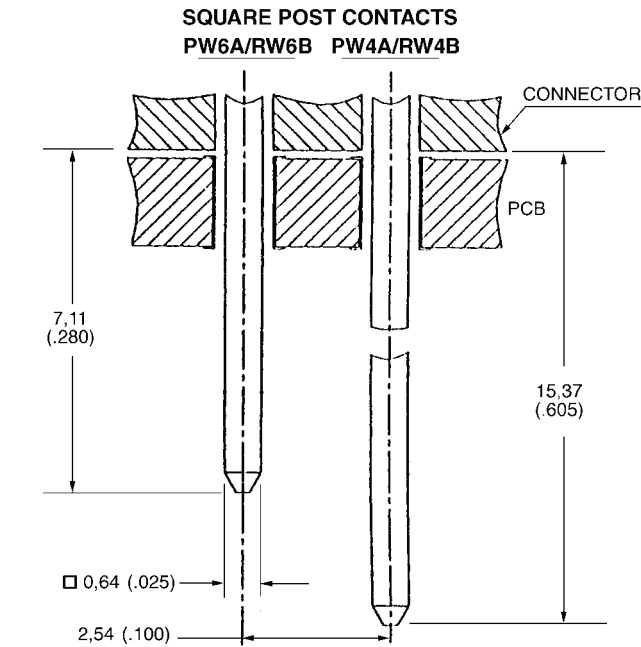

For the PC/RC Versions: The contact tail design has been modified from a 0,64 (.025) square pin to a 0,05 (.020) diameter round pin. The change enables a decrease in the diameter of the through holes as well as the solder mounds on PCB's (d1 and d2 can be wider than D1 and D2). This can reduce the crosstalk in RF circuits and enhance the dielectric withstanding voltage in high voltage circuits.

The soldering of contacts into through (THRU) holes on a PC Board has become standard for medical equipment and test equipment for semi-conductors. As a result of the narrow spacing between the solder pad and circuit pattern, crosstalk between signals increases. A solution to this problem is to make the diameter of the contacts and solder lands smaller to provide more space between the lands and the patterns. However a smaller diameter contact results in higher impedance.

Cannon designed a solution with a smaller diameter contact tail. This design

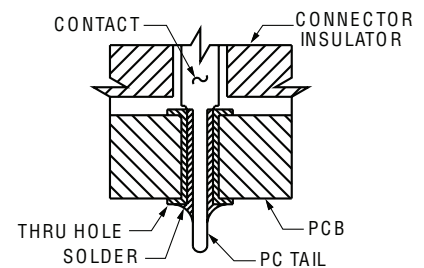

## DL1 / DLM1 / DLD1 Printed Circuit Board Hole Patterns

DL1-156/DLM1-156

Plug 

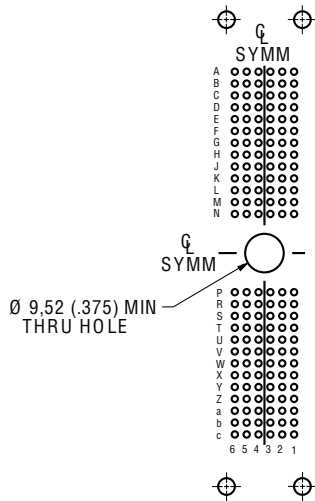

Receptacle

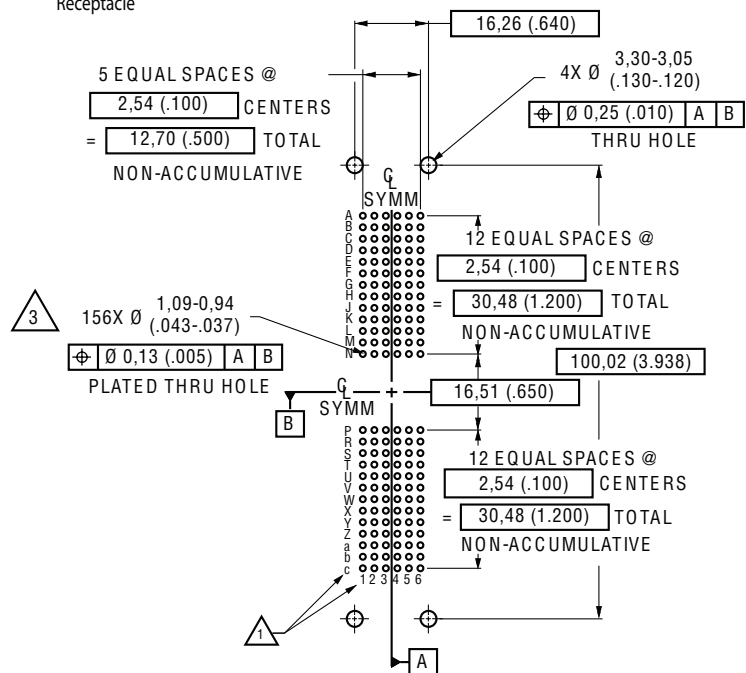

DLD1-156

Plug 

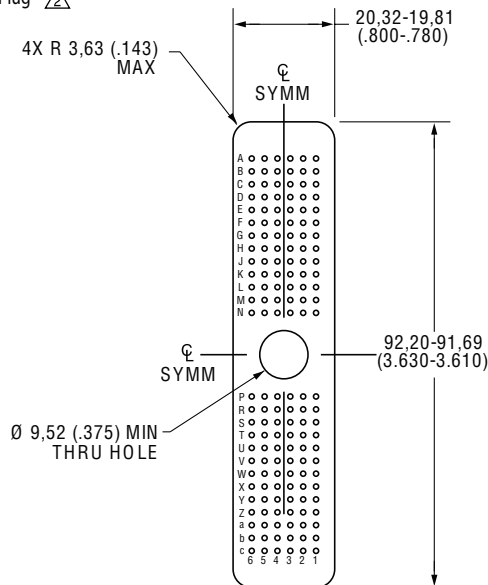

Receptacle

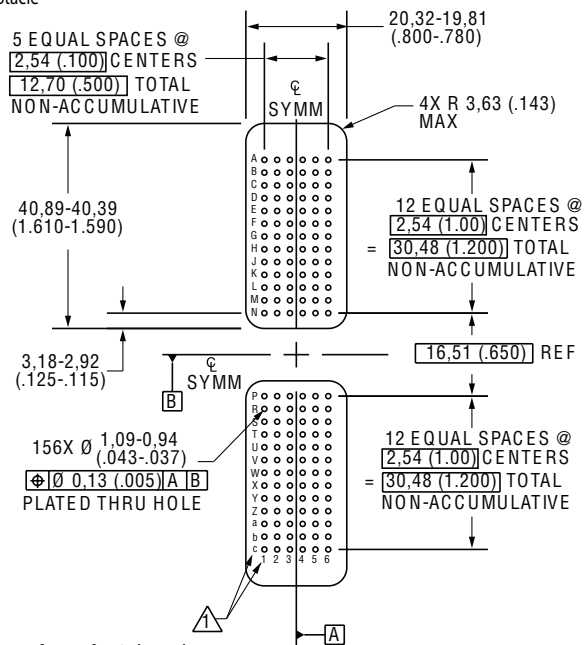

**Notes:**

- Contact hold cavity identifications shown are typical as viewed from top surface of P.C. board.
- All plug layout dimensions not shown are similar to the receptacle dimensions
- Plated through (THRU) hole diameters shown are for 0,64 (.025) post contacts. PC/RC contact plated through (THRU) hole diameters are 0,79 - 0,64 (.031-.025). For PCB pad layout configuration see page

## DL2 / DLM2 / DLD2 Printed Circuit Board Hole Patterns

DL2-96/DLM2-96

Plug 

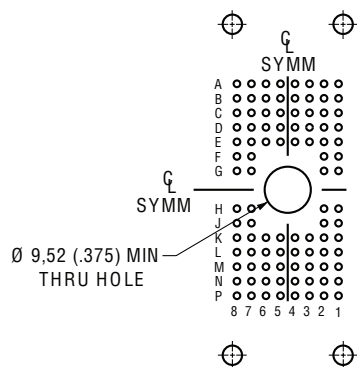

Receptacle

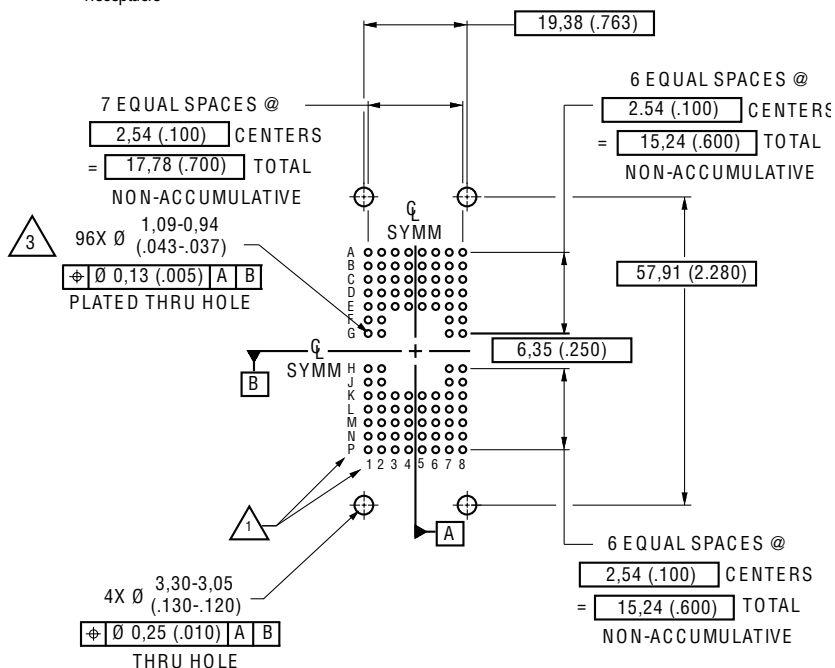

DLD2-96

Plug 

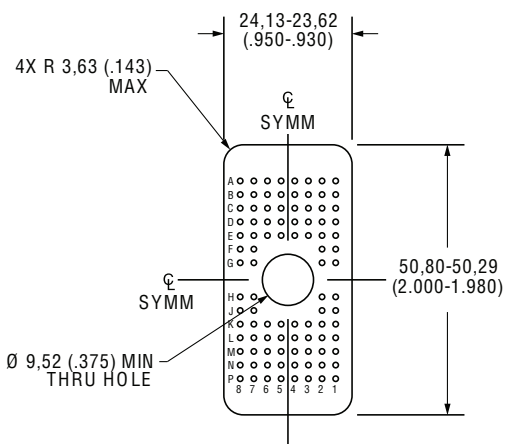

Receptacle

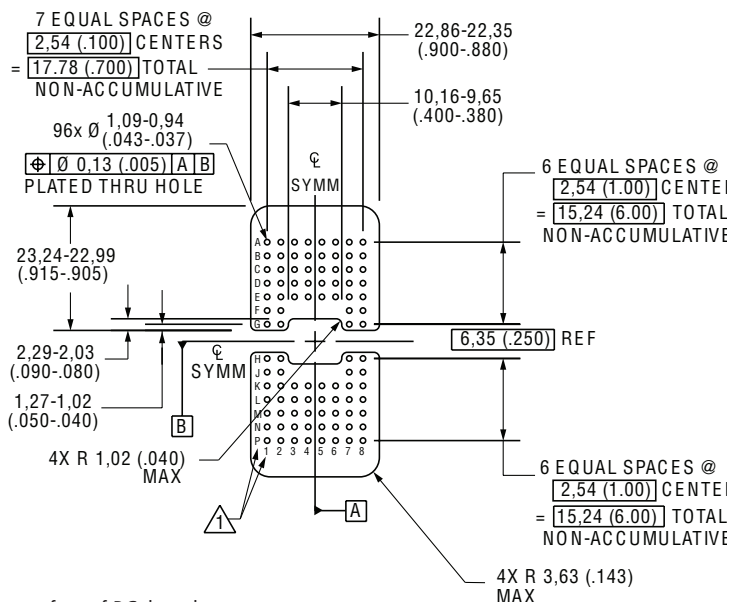

Notes:

1. Contact hold cavity identifications shown are typical as viewed from top surface of P.C. board.
2. All plug layout dimensions not shown are similar to the receptacle dimensions
3. Plated through (THRU) hole diameters shown are for 0,64 (.025) post contacts. PC/RC contact plated through (THRU) hole diameters are 0,79 - 0,64 (.031-.025). For PCB pad layout configuration see page



Dimensions shown in mm (inch)  
Specifications and dimensions subject to

[www.ittcannon.com](http://www.ittcannon.com)

## DL3 / DLM3 / DL5 / DLM5 Printed Circuit Board Hole Patterns

DL3-60/DLM3-60

Plug 

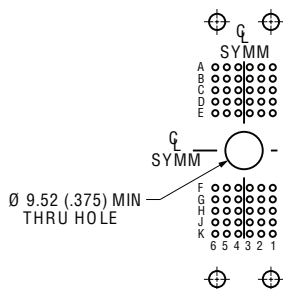

Receptacle

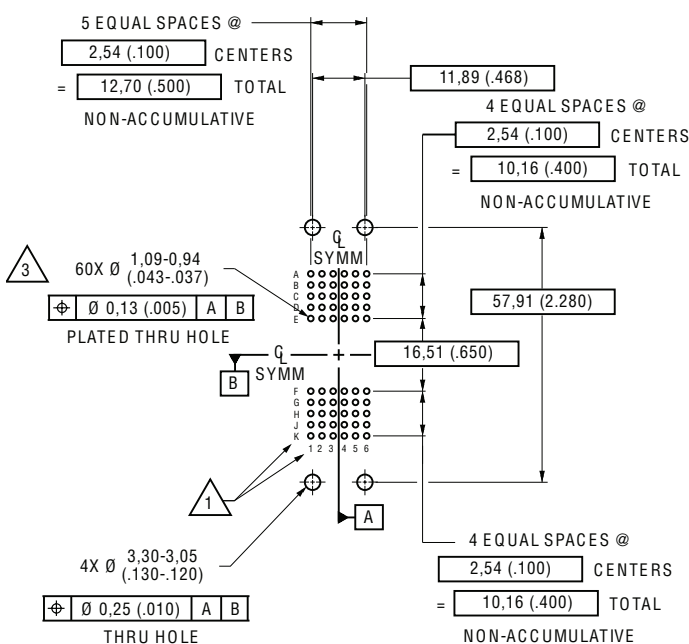

DL5-260/DLM5-260

Plug 

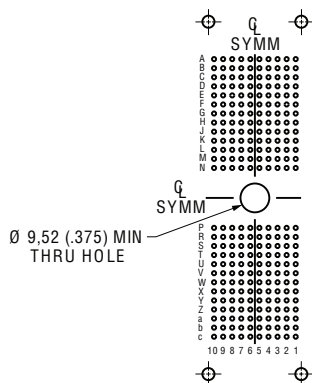

Receptacle

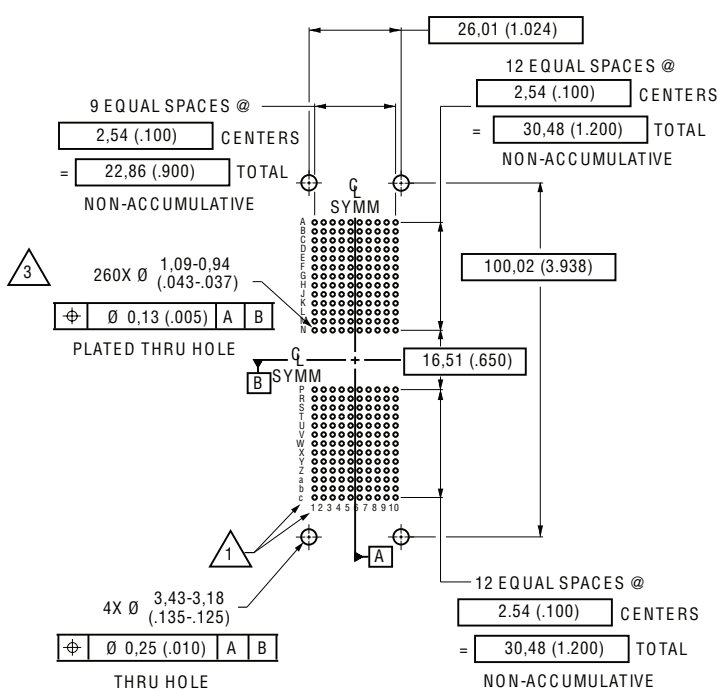

**Notes:**

1. Contact hold cavity identifications shown are typical as viewed from top surface of P.C. board.
2. All plug layout dimensions not shown are similar to the receptacle dimensions
3. Plated through (THRU) hole diameters shown are for 0,64 (.025) post contacts. PC/RC contact plated through (THRU) hole diameters are 0,79 - 0,64 (.031-.025). For PCB pad layout configuration see page

## DL5 Plastic Press-Fit (Receptacle only)

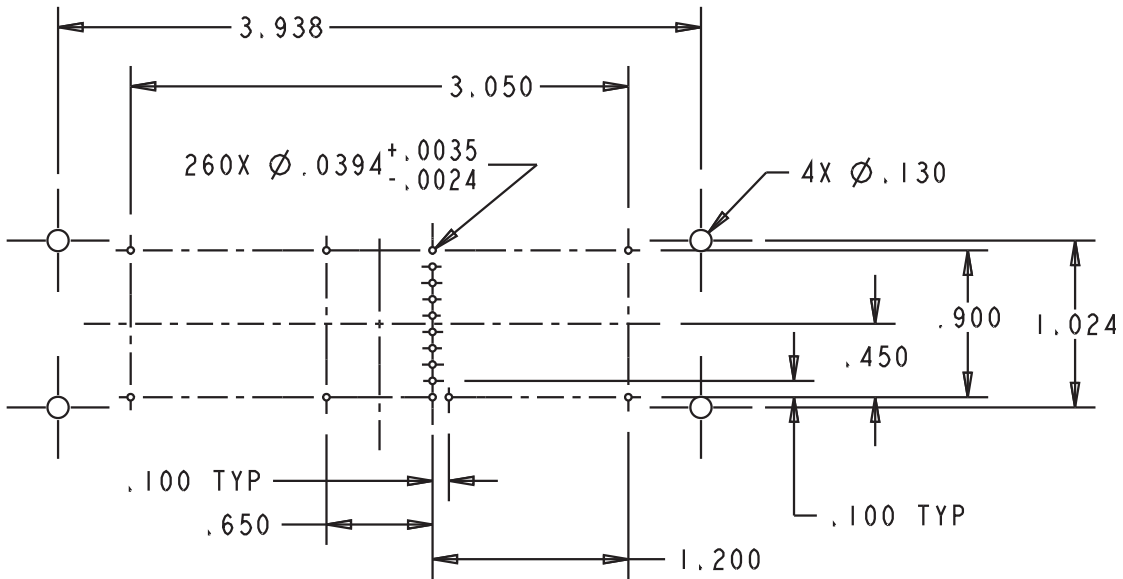

## DLM5 Press-Fit Printed Circuit Board Hole Patterns

### Plug

THROUGH HOLE SPECIFICATION 260-D T.H.

|                 | T. H. SOLDER T.H.    | T. H. COPPER T.H.           |
|-----------------|----------------------|-----------------------------|
| HOLE DIA. D     | $\phi 0.6 \pm 0.075$ | $\phi 0.6^{+0.075}_{-0.05}$ |
| DRILL HOLE DIA. | $\phi 0.7 \pm 0.025$ | $\phi 0.7 \pm 0.025$        |
| Cu PLATING      | 20~50 $\mu$ m        | 25~65 $\mu$ m               |
| Sn/Pb PLATING   | 5~15 $\mu$ m         |                             |

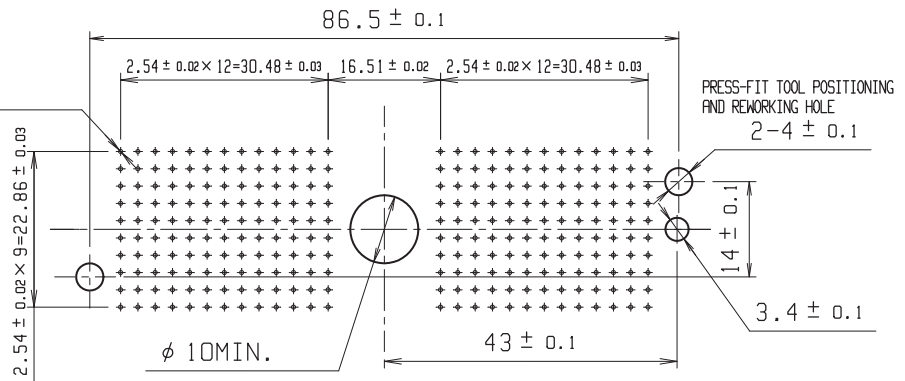

RECOMMENDED PCB THICKNESS t=1.6

### Receptacle

THROUGH HOLE SPECIFICATION

|                 | T. H. SOLDER T.H.    | T. H. COPPER T.H.           |
|-----------------|----------------------|-----------------------------|
| HOLE DIA. D     | $\phi 0.6 \pm 0.075$ | $\phi 0.6^{+0.075}_{-0.05}$ |
| DRILL HOLE DIA. | $\phi 0.7 \pm 0.025$ | $\phi 0.7 \pm 0.025$        |
| Cu PLATING      | 20~50 $\mu$ m        | 25~65 $\mu$ m               |
| Sn/Pb PLATING   | 5~15 $\mu$ m         |                             |

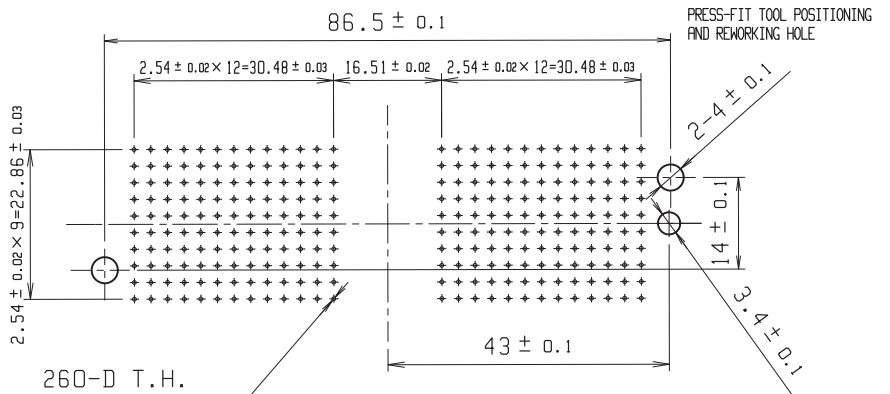

t=1.6



Dimensions shown in mm (inch)  
Specifications and dimensions subject to

www.ittcannon.com

## DLM6 Printed Circuit Board Hole Patterns

DLM6-360

### Plug

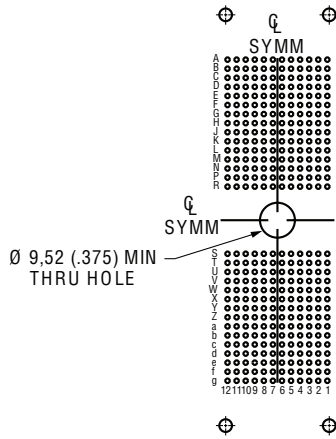

### Receptacle

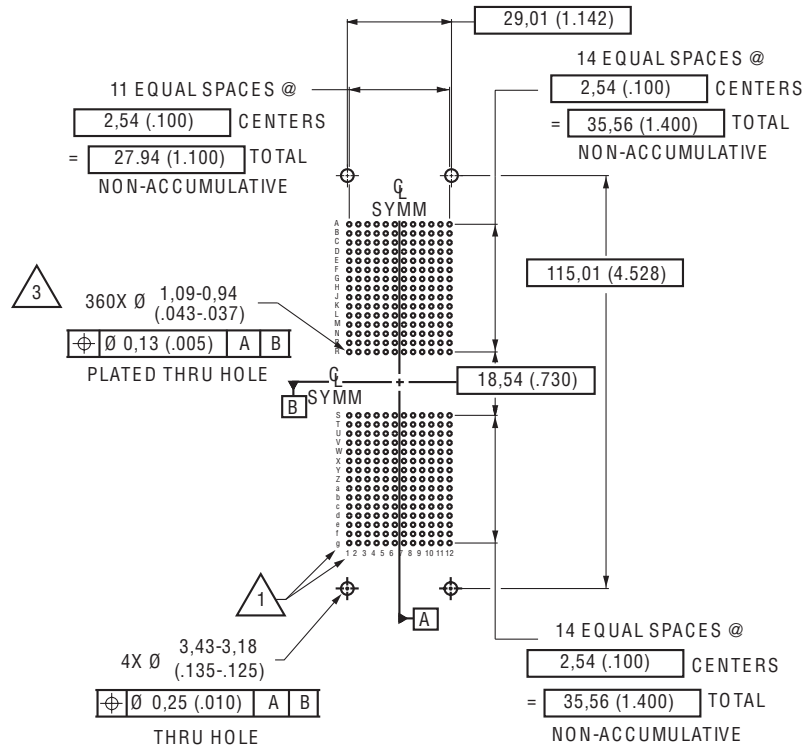

#### Notes:

1. Contact hold cavity identifications shown are typical as viewed from top surface of P.C. board.
2. All plug layout dimensions not shown are similar to the receptacle dimensions
3. Plated through (THRU) hole diameters shown are for 0,64 (.025) post contacts. PC/RC contact plated through (THRU) hole diameters are 0,79 - 0,64 (.031-.025). For PCB pad layout configuration see page

## DLP-272 Printed Circuit Board Pad Layout

### Plug

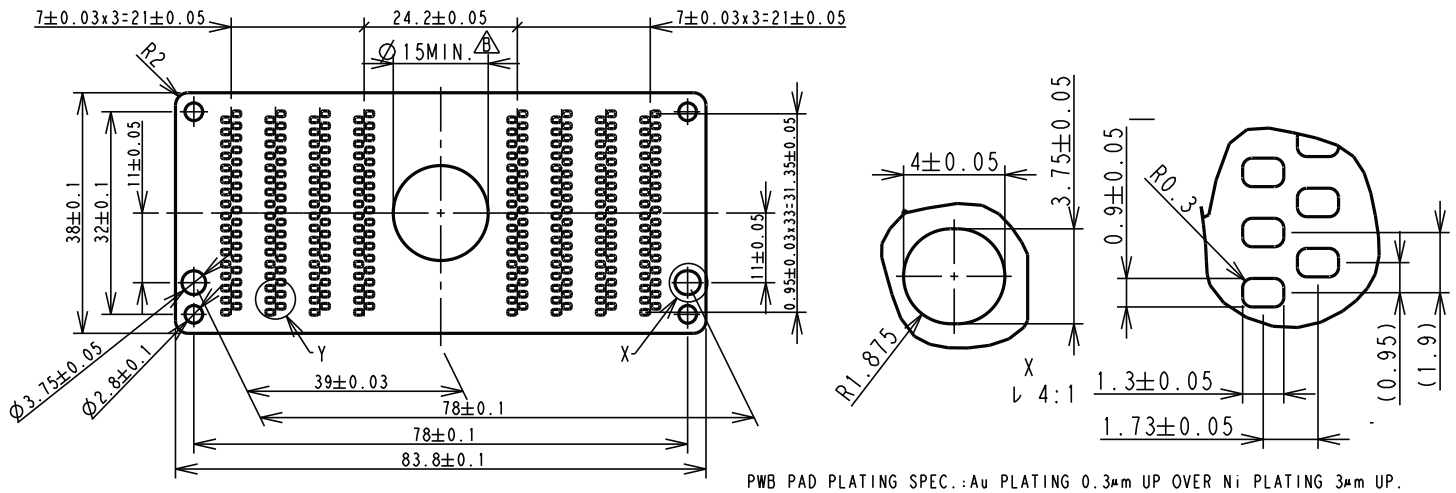

## DLP-272 Printed Circuit Board Hole Pattern

### Receptacle

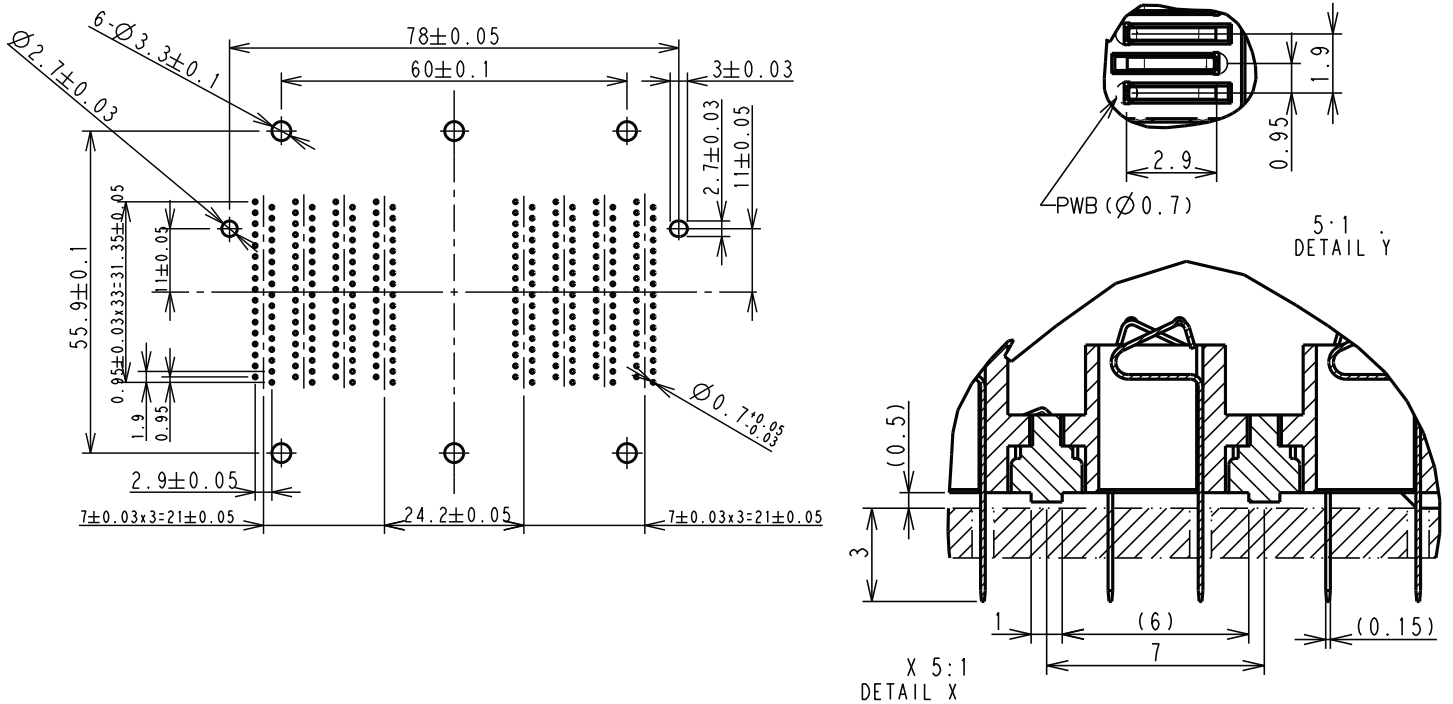



## DLP 408 Printed Circuit Board Pad Layout / Hole Patterns

### Plug

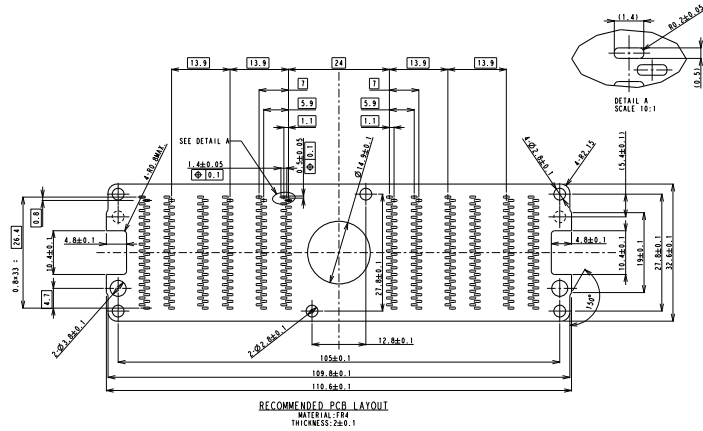

### Receptacle

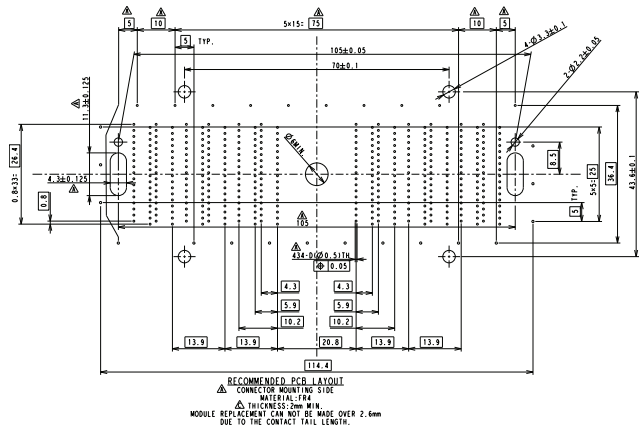

Note: PWB Pad plating Gold 5 μm up over nickel 6 μm up

## QLC Printed Circuit Board Pad Layout / Hole Patterns

### Plug

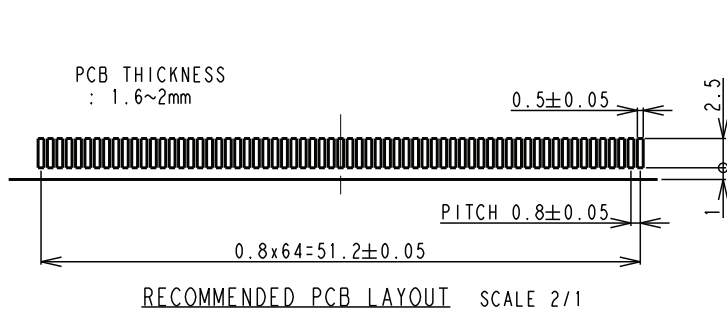

### Receptacle

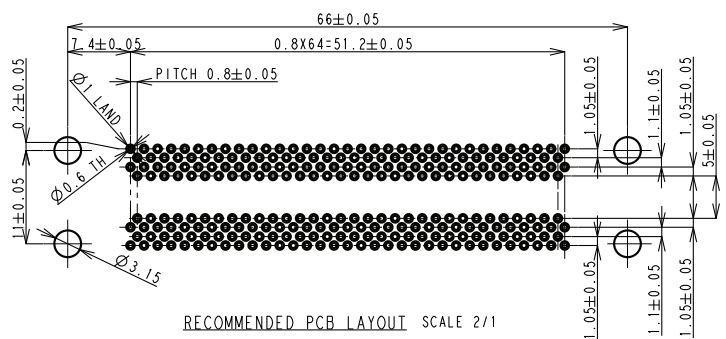

## DL / DLM panel Cutouts and Mounting Hole Patterns

DL1-156/DLMI-156

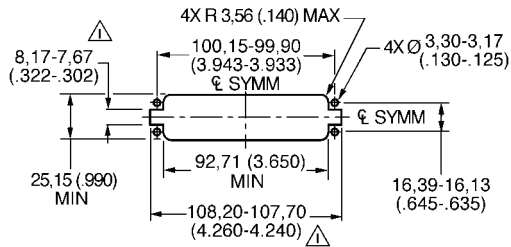

$\triangle$  Required for Center Mounting Polarization Only

DL2-96/DLM2-96

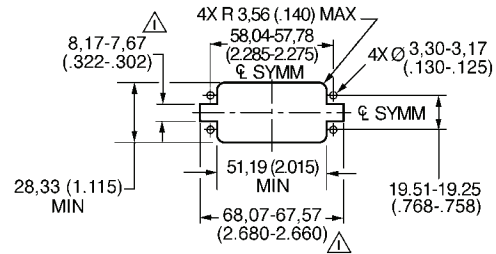

$\triangle$  Required for Center Mounting Polarization Only

DL3-60/DLM3-60

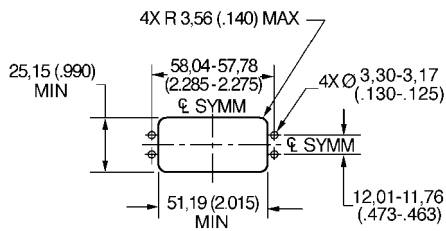

DL4-624

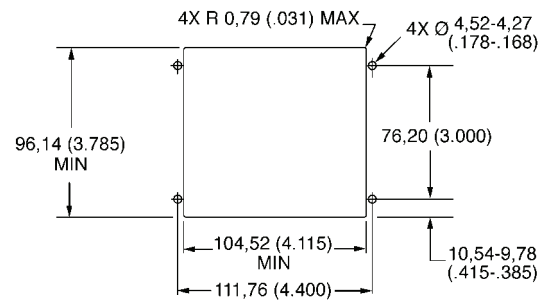

DL5-260/DLM5-260

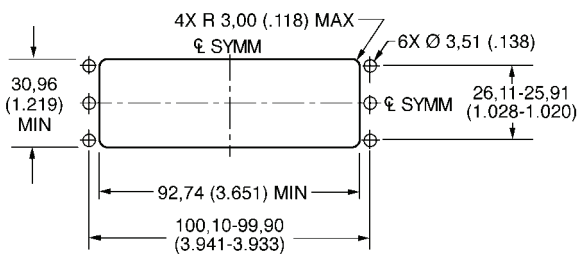

DLM6-360

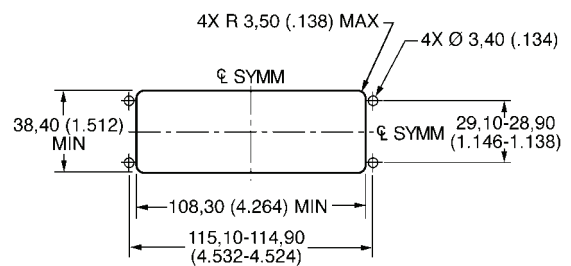

## DLD1 Panel Cutouts and Mounting Hole Patterns

### DLD1-156 Plug

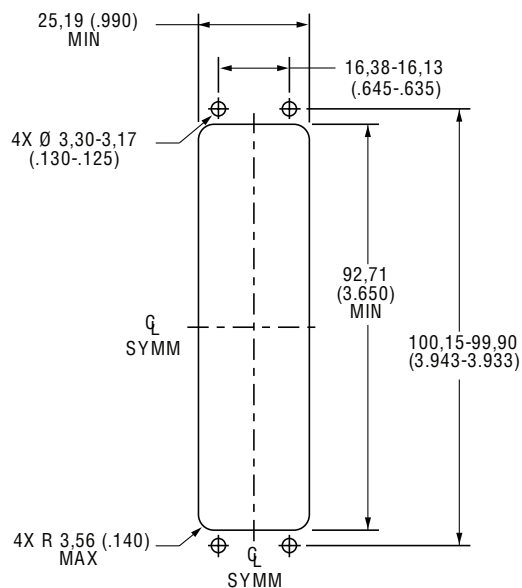

### DLD1-156 Receptacle

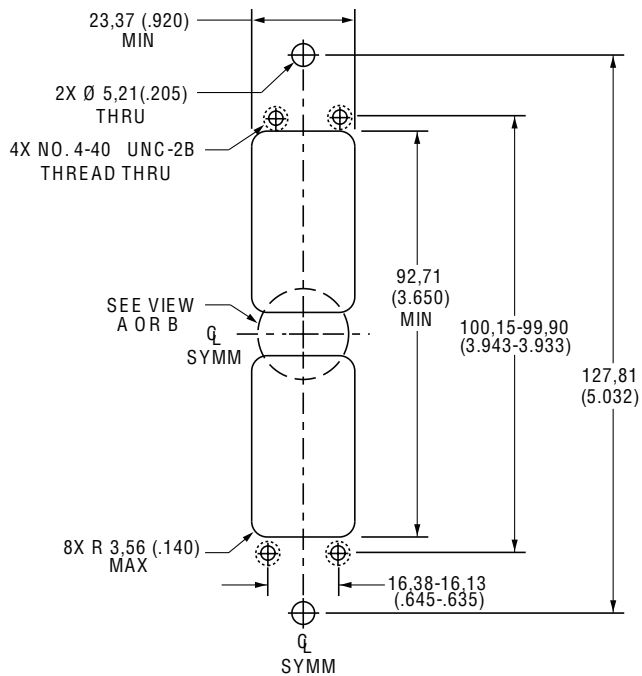

### Front Panel Bridge

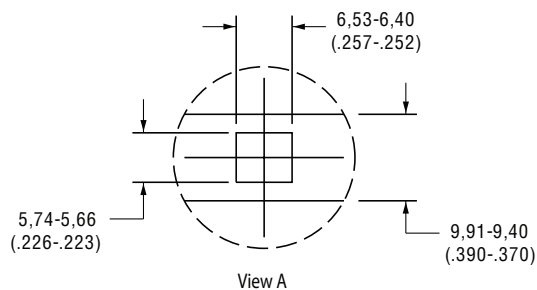

### Rear Panel Bridge

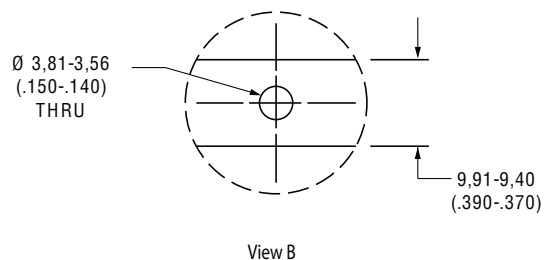

## DLD2 Panel Cutouts and Mounting Hole Patterns

### DLD2-96 Plug

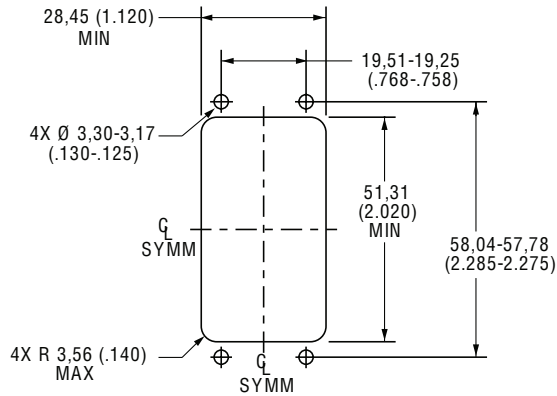

### DLD2-96 Receptacle

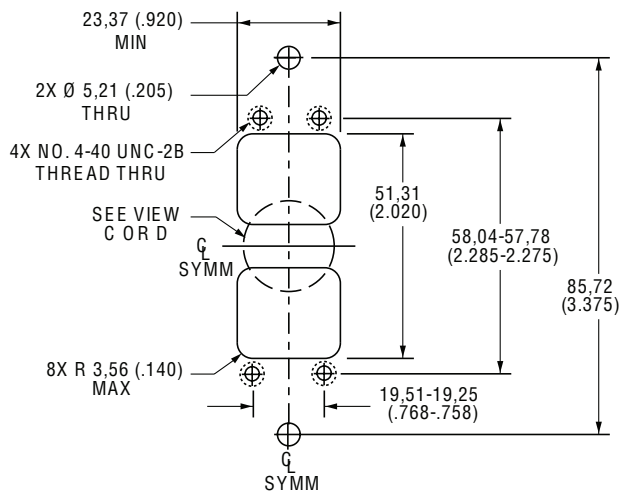

### Front Panel Bridge

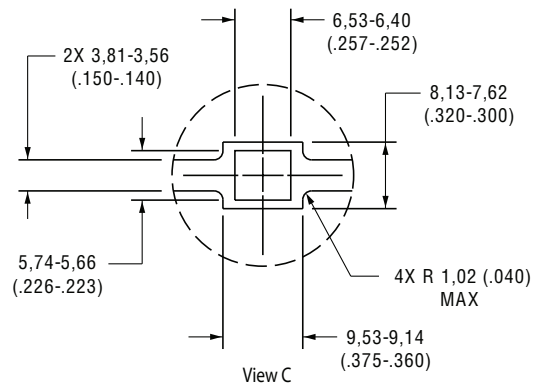

### Rear Panel Bridge

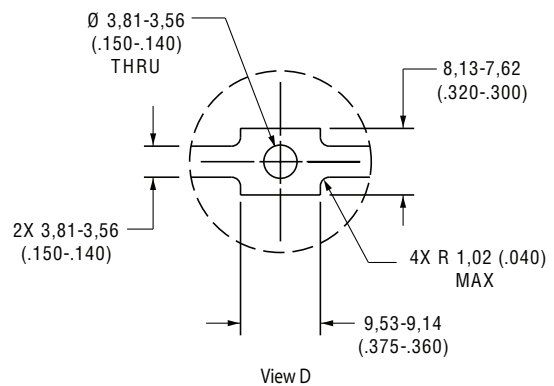

Dimensions shown in mm (inch)  
Specifications and dimensions subject to

[www.ittcannon.com](http://www.ittcannon.com)

## Contact Cavity Arrangements - Rear View

DL1-156/DLMI-156/DLDI-156

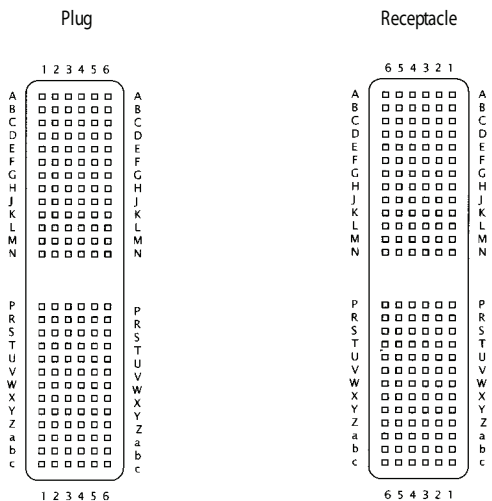

DL2-96/DLM2-96/DLD2-96

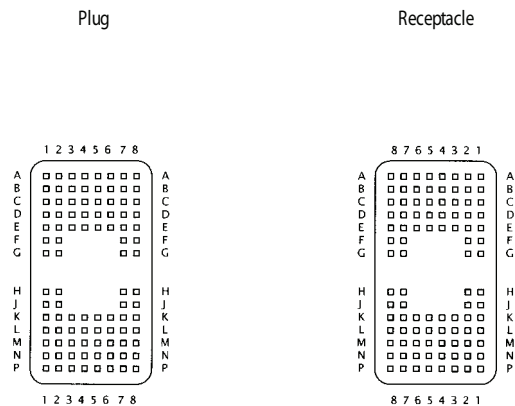

DL3-60/DLM3-60

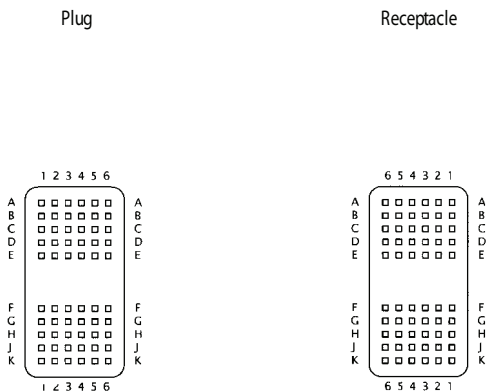

## Contact Cavity Arrangements - Rear View

DL4-624

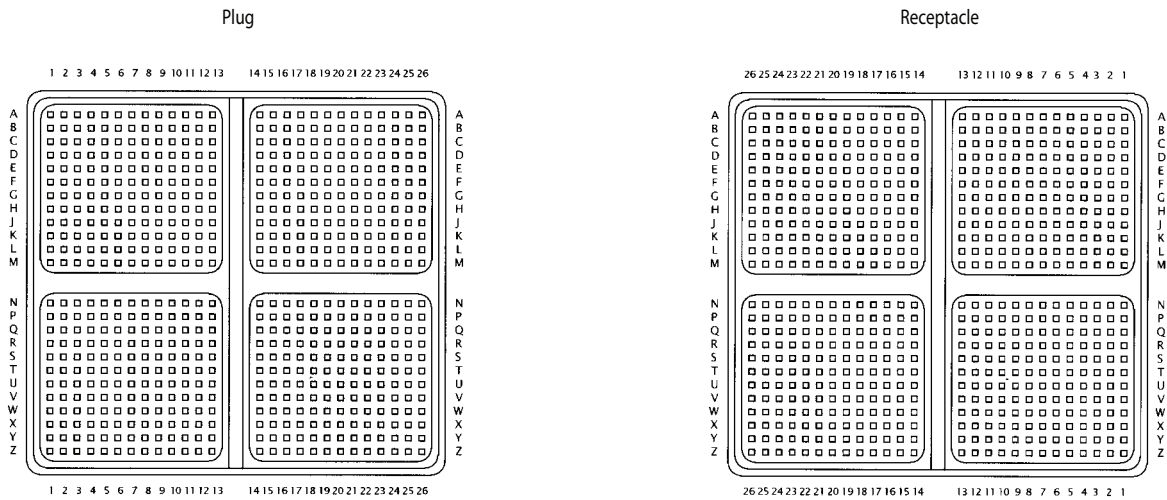

DL5-260/DLM5-260

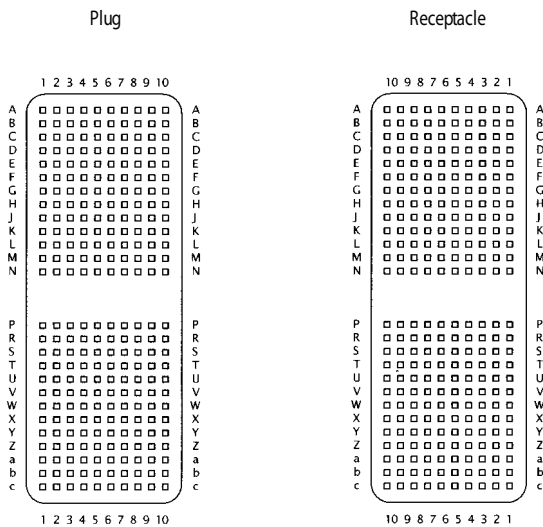

DLM6-360

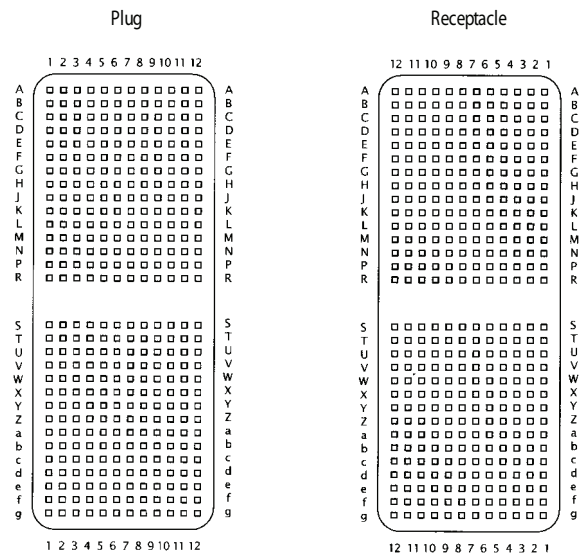

# Cannon ZIF Connectors

## Contact Cavity Arrangement

### Contact Cavity Arrangements

#### DLP 272

**Front View**

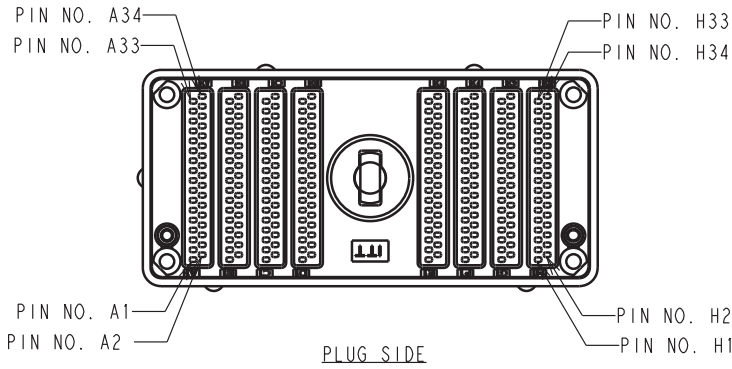

**Rear View**

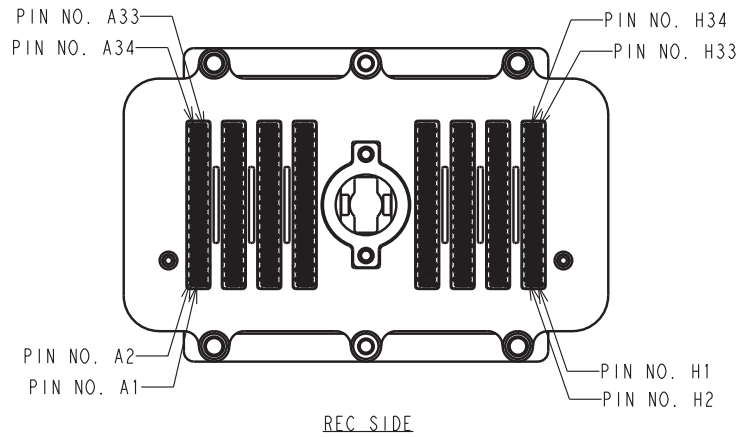

#### DLP 408

**Front View**

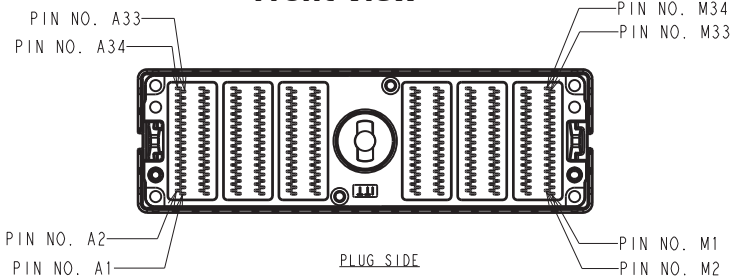

**Rear View**

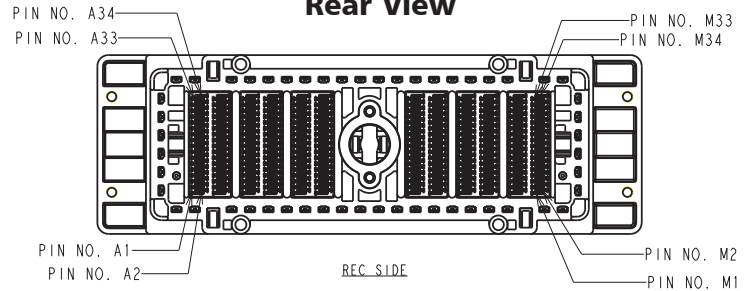

#### QLC

**Front View**

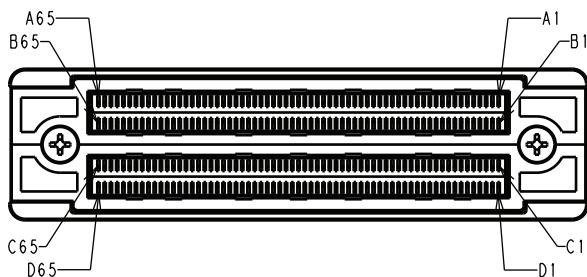

**Rear View**

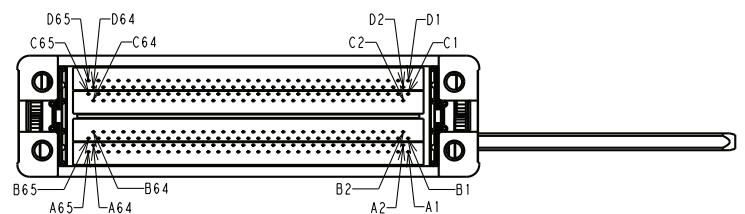

## DLD Drawer - Assembly Dimensions

DLD Assembly Dimensions



The DLD Drawer features ZIF assembly for greater contact life and eliminates the rod normally used in such products.

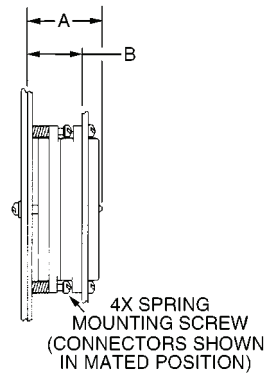
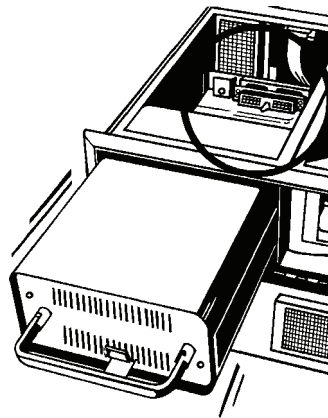
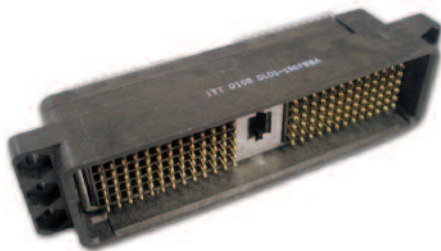

| Shell Size | Contact Type | A REF         | B REF         |
|------------|--------------|---------------|---------------|
| DLD1       | Crimp        | 46,86 (1.845) | 31,75 (1.250) |
| DLD1       | Square Post  | 57,03 (2.245) | 41,91 (1.650) |
| DLD2       | Crimp        | 46,86 (1.845) | 31,75 (1.250) |
| DLD2       | Square Post  | 57,03 (2.245) | 41,91 (1.650) |

## DLD Drawer -Mating Sequence

Figure 1

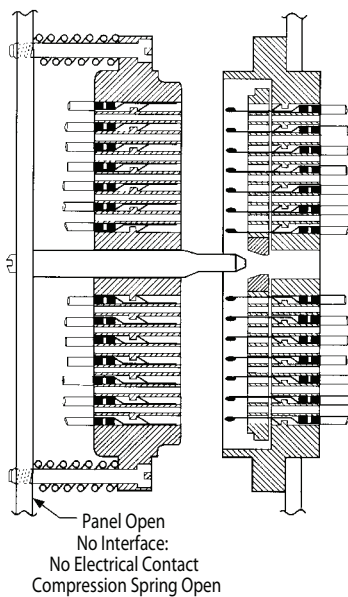

Contacts Aligned

Figure 2

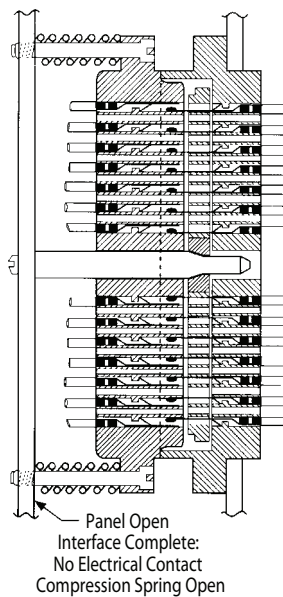

Contacts Aligned

Figure 3

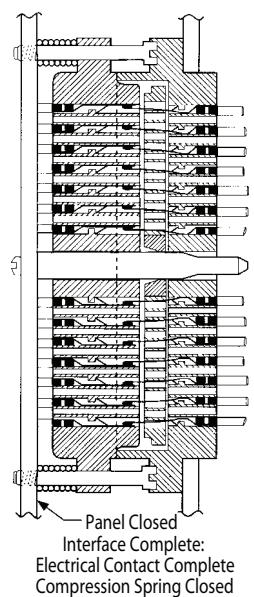

Contacts Aligned



### 1. MATERIAL CONTENT AND PHYSICAL FORM

Electrical connectors do not usually contain hazardous materials. They contain conducting and non-conducting materials and can be divided into two groups.

a) Printed circuit types and low cost audio types which employ all plastic insulators and casings.

b) Rugged, Fire Barrier and High Reliability types with metal casings and either natural rubber, synthetic rubber, plastic or glass insulating materials. Contact materials vary with type of connector and also application and are usually manufactured from either: Copper, copper alloys, nickel, alumel, chromel or steel. In special applications, other alloys may be specified.

### 2. FIRE CHARACTERISTICS AND ELECTRIC SHOCK HAZARD

**There is no fire hazard when the connector is correctly wired and used within the specified parameters. Incorrect wiring or assembly of the connector or careless use of metal tools or conductive fluids, or transit damage to any of the component parts may cause electric shock or burns. Live circuits must not be broken by separating mated connectors as this may cause arcing, ionization and burning.** Heat dissipation is greater at maximum resistance in a circuit. Hot spots may occur when resistance is raised locally by damage, e.g. cracked or deformed contacts, broken strands of wire. Local overheating may also result from the use of the incorrect application tools or from poor quality soldering or slack screw terminals. Overheating may occur if the ratings in the product Data Sheet/Catalog are exceeded and can cause breakdown of insulation and hence electric shock. If heating is allowed to continue it intensifies by further increasing the local resistance through loss of temper of spring contacts, formation of oxide film on contacts and wires and leakage currents through carbonization of insulation and tracking paths. Fire can then result in the presence of combustible materials and this may release noxious fumes. Overheating may not be visually apparent. Burns may result from touching overheated components.

Heat dissipation is greater at maximum resistance in a circuit. Hot spots may occur when resistance is raised locally by damage, e.g. cracked or deformed contacts, broken strands of wire. Local overheating may also result from the use of the incorrect application tools or from poor quality soldering or slack screw terminals. Overheating may occur if the ratings in the product Data Sheet/Catalog are exceeded and can cause breakdown of insulation and hence electric shock. If heating is allowed to continue it intensifies by further increasing the local resistance through loss of temper of spring contacts, formation of oxide film on contacts and wires and leakage currents through carbonization of insulation and tracking paths. Fire can then result in the presence of combustible materials and this may release noxious fumes. Overheating may not be visually apparent. Burns may result from touching overheated components.

### 3. HANDLING

Care must be taken to avoid damage to any component parts of electrical connectors during installation and use. Although there are normally no sharp edges, care must be taken when handling certain components to avoid injury to fingers. Electrical connectors may be damaged in transit to the customers, and damage may result in creation of hazards. Products should therefore be examined prior to installation/use and rejected if found to be damaged.

### 4. DISPOSAL

Incineration of certain materials may release noxious or even toxic fumes.

### 5. APPLICATION

Connectors with exposed contacts should not be selected for use on the current supply side of an electrical circuit, because an electric shock could result from touching exposed contacts on an unmated connector. Voltages in excess of 30 V ac or 42.5 V dc are potentially hazardous and care should be taken to ensure that such voltages cannot be transmitted in any way to exposed metal parts of the connector body. The connector and wiring should be checked, before making live, to have no damage to metal parts or insulators, no solder blobs, loose strands, conducting lubricants, swarf, or any other undesired conducting particles. Circuit resistance and continuity check should be made to make certain that there are no high resistance joints or spurious conducting paths. Always use the correct application tools as specified in the Data Sheet/Catalog. Do not permit untrained personnel to wire, assemble or tamper with connectors. For operation voltage please see appropriate national regulations.

### IMPORTANT GENERAL INFORMATION

**(i) Air and creepage paths/Operating voltage.** The admissible operating voltages depend on the individual applications and the valid national and other applicable safety regulations.

For this reason the air and creepage path data are only reference values. Observe reduction of air and creepage paths due to PC board and/or harnessing.

### (ii) Temperature

All information given are temperature limits. The operation temperature depends on the individual application.

### (iii) Other important information

Cannon continuously endeavors to improve their products. Therefore, Cannon products may deviate from the description, technical data and shape as shown in this catalog and data sheets.

ITT Interconnect Solutions, a Division of ITT Corporation manufactures the highest quality products available in the marketplace; however these products are intended to be used in accordance with the specifications in this publication. Any use or application that deviates from the stated operating specifications is not recommended and may be unsafe. No information and data contained in this publication shall be construed to create any liability on the part of Cannon. Any new issue of this publication shall automatically invalidate and supersede any and all previous issues.

### Product Warranty

A limited warranty applies to Cannon products. In general, except for obligations assumed by Cannon under this warranty, Cannon shall not be liable for any loss, damage, cost of repairs, incidental or consequential damages of any kind, whether or not based on express or implied warranty, contract, negligence or strict liability arising in connection with the design, manufacture, sale, use or repair of the products. Product availability, prices and delivery dates are exclusively subject to our respective order confirmation form; the same applies to orders based on development samples delivered. Please refer to [www.ittcannon.com](http://www.ittcannon.com) (General Terms of Sale) for the complete text of Cannon's applicable Terms and Conditions, including Warranty.

This publication is not to be construed as an offer. It is intended merely as an invitation to make an offer. By this publication, Cannon does not assume responsibility or any liability for any patent infringements or other rights of third parties which may result from its use.

Reprinting this publication is generally permitted, indicating the source. However, Cannon's prior consent must be obtained in all cases. "Engineered for life" is a registered trademark of ITT Corporation ©2006. All other trademarks or registered trademarks are property of their respective owners. All dates subject to change without notice.

*Commodities in this catalog may be controlled for export by the International Traffic in Arms Regulations (ITAR) and Export Administration Regulations (EAR) when specifically designed modified, or configured for articles controlled by the United States Government.*



## Circular/Filter/Hermetic/Fiber Optic Connectors

As a world leader in circular, filter, and hermetic connectors, ITT can leverage its design and manufacturing expertise to fit virtually any application. Our expertise includes fast positive mating for a wide range of military applications, as well as numerous sizes and contact configurations for various harsh environments. Our wide variety of fiber optic products include hybrid contacts, multi-channel, rack and panel, and hi-rel assemblies, including MIL and ARINC standard solutions. ITT can meet numerous specs, including NATO and MIL standards.



[www.ittcannon.com/circulars](http://www.ittcannon.com/circulars) • [www.ittcannon.com/filter](http://www.ittcannon.com/filter) • [www.ittcannon.com/hermetics](http://www.ittcannon.com/hermetics) • [www.ittcannon.com/fiberoptics](http://www.ittcannon.com/fiberoptics)

## D-Subminiature Connectors

Cannon invented D-sub connectors in 1952. Our family of D-Subs now includes combinations of signal, power and RF, as well as severe service sealed connectors. Cannon D-Subs are available with an extensive line of backshells and accessories and are one of the most economical shielded connector solutions available. ITT D-Sub connectors are qualified to the MIL-DTL-24308 specification.

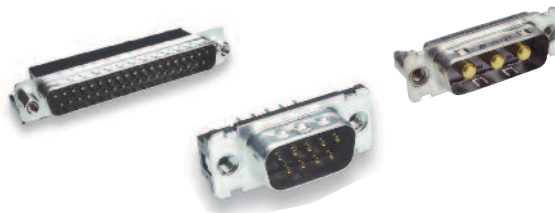

[www.ittcannon.com/dsubs](http://www.ittcannon.com/dsubs)

## Microminiature Connectors

Developed first by Cannon in the 1960's, Interconnect Solutions microminiature connectors offer high performance and reliability with exceptional versatility. Available in rectangular, circular, and strip configurations for countless applications, many of our connectors meet or exceed applicable requirements of the MIL-DTL-83513 specification.



[www.ittcannon.com/micro](http://www.ittcannon.com/micro)

## Rack and Panel Connectors

Initially pioneered by Cannon during the 1930s, Interconnect Solutions is the world leader in rack and panel connectors, offering unmatched variety of shell configurations and insert arrangements, materials, plating, and contact options. Many of our standard and custom designs meet the stringent requirements of ARINC 600, ARINC 404 (MIL-C-81659), and MIL-DTL-83733 standards.

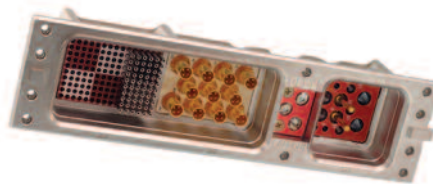

[www.ittcannon.com/rackandpanel](http://www.ittcannon.com/rackandpanel)

## RF Connectors

ITT Interconnect Solutions has been providing interconnect products to the Microwave and RF industry since 1963 (formerly The Sealectro Corporation). The RF 50 & 75 Ohm product lines cover UHF band through Ku band requirements. These connectors and cable assemblies are available with a thread type, snap type, bayonet type or slide on coupling method. The frequencies range from DC to 18+ GHz.



[www.ittcannon.com/RF50](http://www.ittcannon.com/RF50) • [www.ittcannon.com/RF75](http://www.ittcannon.com/RF75)

## Transportation

The ITT ICS interconnect range includes sealed circular and rectangular connectors in metal or plastic shells. These configurations include board to cable or cable to cable/ bulkhead applications. Both signal and power contacts can be combined in various layouts. All product lines within the Transportation segment offer very low contact resistance providing maximum signal integrity.



[www.ittcannon.com/transportation](http://www.ittcannon.com/transportation)

ITT Interconnect Solutions is an international manufacturer and supplier of connectors including circular, rectangular, fiber optic, RF, power and high voltage, audio, PMCIA, Compact Flash Card, enclosures, cable assemblies, and application specific custom solutions. The Interconnect Solutions portfolio includes the brands Cannon, VEAM, and BIW. As a worldwide leader in connector technology for nearly a century, ITT offers one of the broadest product offerings, six sigma manufacturing capability, Value Based Product Development with exceptional engineering capability, and an extensive sales, distribution, and customer support network.





# ITT

## Customer Support Locations

### *CHINA*

Tuopandun Industrial Area, Jinda Cheng,  
Xiner Village, Shajing Town,  
Baoan District, Shenzhen City,  
Guangdong, China 518125  
Phone: +86.755.2726.7238  
Fax: +86.755.2726.7515

### *GERMANY*

Cannonstrasse 1  
Weinstadt, 71384  
phone: +49.7151.699.0  
fax: +49.7151.699.217

### *FRANCE*

15, Boulevard Robert Thiboust  
Serris, France 77700  
phone: +33.1.60.04.93.93  
fax: +33.1.60.04.93.90

### *HONG KONG*

Units 2405-6, 24/F, ING Tower  
308 Des Voeux Road  
Central  
Hong Kong  
phone: +852.2732.2720  
fax: +852.2732.2919

### *ITALY*

Corso Europa 41/43  
Lainate (MI),  
Italy 20020  
phone: +39.02938721  
fax: +39.0293872300

### *JAPAN*

11-3, 5 Chome, Hibarigaoka, Zama-shi  
Kanagawa, Japan 228-0003  
phone: +52.631.311.0050  
fax: + 52.631.314.0060

### *UK*

Jays Close, Viables Estate  
Basingstoke, RG22 4BA  
phone: +44.1256.311200  
fax: +44.1256.323356

### *USA*

666 East Dyer Road  
Santa Ana, CA 92705  
toll free: 1.800.854.3028  
phone: 1.714.557.4700  
fax: 1.714.628.2142

©2009 ITT Corporation. "ITT," "Engineered for Life," the ITT Engineered Blocks Logo, "Cannon," "BIW Connector Systems," and "VEAM" are trademarks of ITT Corporation. Specification and other data are based on information available at the time of printing, and are subject to change without notice.

Space Connectors January 2009

**[www.ittcannon.com](http://www.ittcannon.com)**