



Texas Instruments Heat Sink

ATS PART # ATS-TI10P-521-C1-R0

Features & Benefits

- » Optimized for natural convection air cooling
- » Black anodized for maximum heat dissipation
- » Designed specifically for TI's Audio Evaluation Module #TPA3116D2EVM

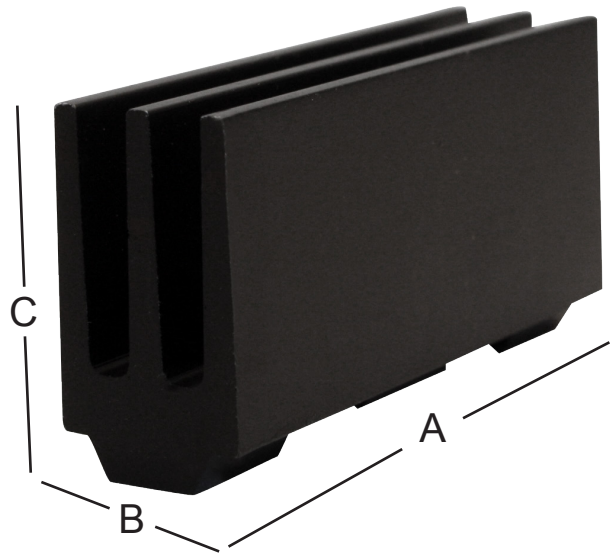
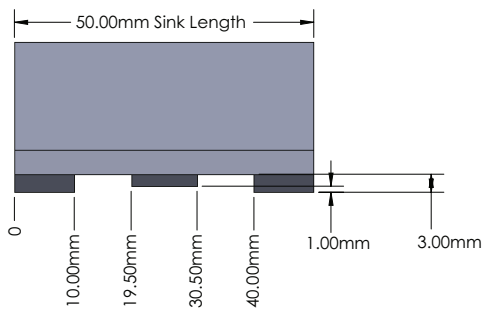

**Image above is for illustration purposes only.*

Thermal Performance

AIR VELOCITY		THERMAL RESISTANCE	
FT/MIN	M/S	°C/W (UNDUCTED FLOW)	°C/W (DUCTED FLOW)
200	1.0	8.5	4.7
300	1.5	6.8	n/a
400	2.0	5.9	n/a
500	2.5	5.3	n/a
600	3.0	4.9	n/a
700	3.5	4.5	n/a
800	4.0	4.3	n/a

Product Details

DIMENSION A	DIMENSION B	DIMENSION C	INTERFACE MATERIAL	FINISH
50 mm	13.9 mm	25 mm	N/A	BLACK ANODIZED

NOTES:

- 1) Dimension C = heat sink height from bottom of the base to the top of the fin field.
- 2) Delivery 4-8 weeks
- 3) Material AL-6063



ATS ADVANCED
THERMAL
SOLUTIONS, INC.
Innovations in Thermal Management®

For more information, to find a distributor or to place an order, visit www.qats.com or call: **781.769.2800**.