

CONFIDENTIAL & PROPRIETARY

THIS INFORMATION IS CONFIDENTIAL AND PROPRIETARY TO LAIRD TECHNOLOGIES. IT MAY NOT BE DISCLOSED TO ANYONE, OTHER THAN LAIRD TECHNOLOGIES PERSONNEL, WITHOUT WRITTEN AUTHORIZATION FROM LAIRD TECHNOLOGIES.

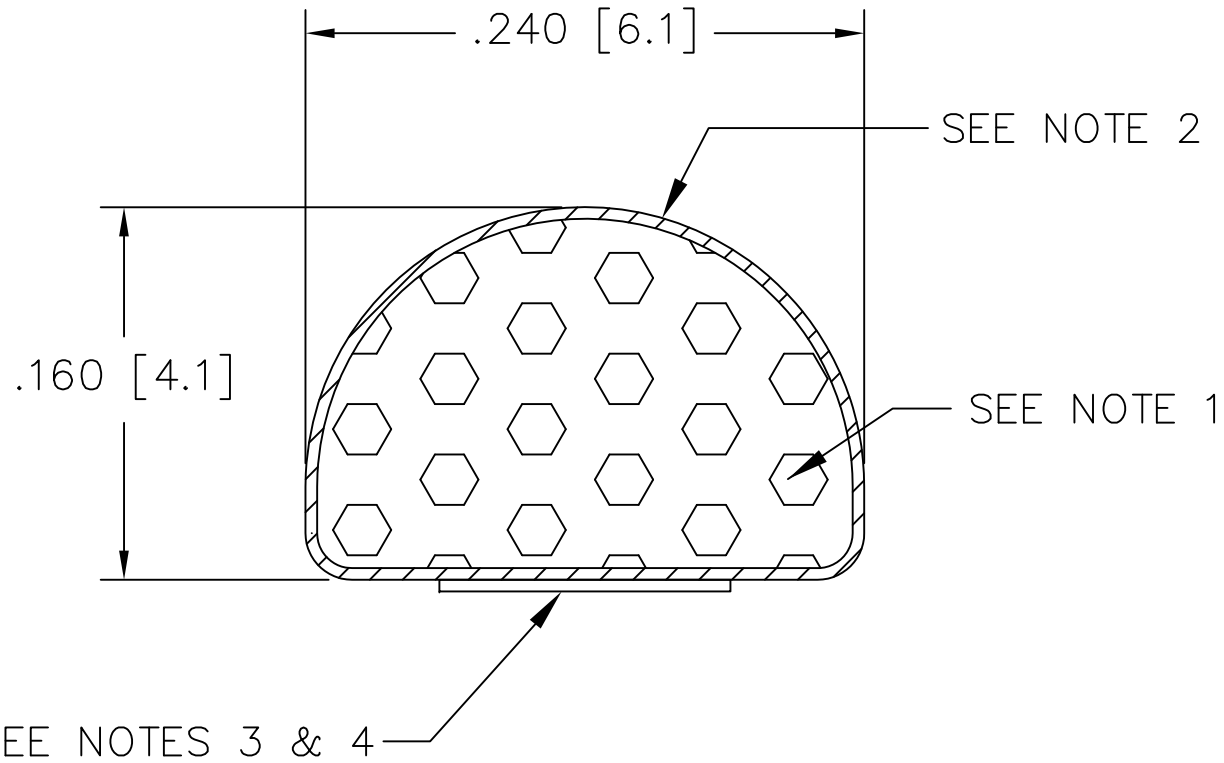

NOTES:

1. FOAM: POLYURETHANE
2. FABRIC: NICKEL NRS FR EcoGreen
3. TAPE: .125" TAPE HI-TEMP
4. LINER: NO EXTENDED RELEASE LINER
5. FABRIC SEAM LOCATION MAY VARY.
6. CARRIER: NO CARRIER
7. THIS PART IS RoHS COMPLIANT AND MEETS THE REQUIREMENTS OF LT-GES-001

REVISIONS:

TITLE: SHIELDING GASKET	
Dwg. or Part No. 4120-PA-51G	REV. 0

DRAWN GIBILTERRA	DATE 3/11/13	SCALE: 1/1
CHECKED BY: FJG	DATE 3/11/13	
RELEASED BY: FJG	DATE 3/11/13	

DIMENSIONS ARE IN INCHES. UNLESS OTHERWISE SPECIFIED, TOLERANCES ARE AS FOLLOWS:		
DECIMALS	LENGTH	
.XX ± .03	0" - 6"	± .030"
.XXX ± .020	6" - 11"	± .050"
	11" - 48"	± .100"
ANGLES	48° - 70°	± .187°
	70° - 144°	± .250°
	± 1/2°	

