



Bridgelux® Gen 7 V10 Array

Product Data Sheet DS100



BXRE-27x1000 | 30x1000 | 35x1000 | 40x1000 | 50x1001 | 57x1001 | 65x1001

Introduction

V Series



The V Series™ LED Array products deliver high quality light in a compact and cost-effective solid-state lighting package. These Chip-on-Board (CoB) arrays can be efficiently driven at twice the nominal drive current, enabling design flexibility not previously possible. This high flux density light source is designed to support a wide range of high quality, low cost directional luminaires and replacement lamps for commercial and residential applications.

The V10 LED Array is available in a variety of electrical, CCT and CRI combinations providing substantial design flexibility and energy efficiencies.

Lighting system designs incorporating these LED Arrays deliver increased system level efficacy and longer service life. Typical applications include, but are not limited to, replacement lamps, task, accent, spot, track, down light, wide area, security, and wall pack.

Features

- Efficacy of 150 lm/W typical
- Compact high flux density light source
- Uniform high quality illumination
- Minimum 70, 80 and 90 CRI options
- Streamlined thermal path
- ENERGY STAR® / ANSI compliant color binning structure with 3 SDCM and 4 SDCM options
- More energy efficient than incandescent, halogen and fluorescent lamps
- Low voltage DC operation
- Instant light with unlimited dimming

Benefits

- Enhanced optical control
- Clean white light without pixilation
- High quality true color reproduction
- Significantly reduced thermal resistance and increased operating temperatures
- Uniform consistent white light
- Lower operating costs
- Easy to use with daylight and motion detectors to enable increased energy savings
- Reduced maintenance costs
- Environmentally friendly, no disposal issue



Contents

Product Feature Map	2
Product Nomenclature	2
Product Selection Guide	3
Performance at Commonly Used Drive Currents	5
Electrical Characteristics	9
Absolute Maximum Ratings	10
Performance Curves	11
Typical Radiation Pattern	15
Typical Color Spectrum	16
Mechanical Dimensions	17
Color Binning Information	18
Packaging and Labeling	19
Design Resources	21
Precautions	21
Disclaimers	21
About Bridgelux	22

Product Feature Map

Bridgelux arrays are fully engineered devices that provide consistent thermal and optical performance on an engineered mechanical platform. The V Series arrays are the most compact chip-on-board devices across all of

Bridgelux's LED Array products. The arrays incorporate several features to simplify design integration and assembly.

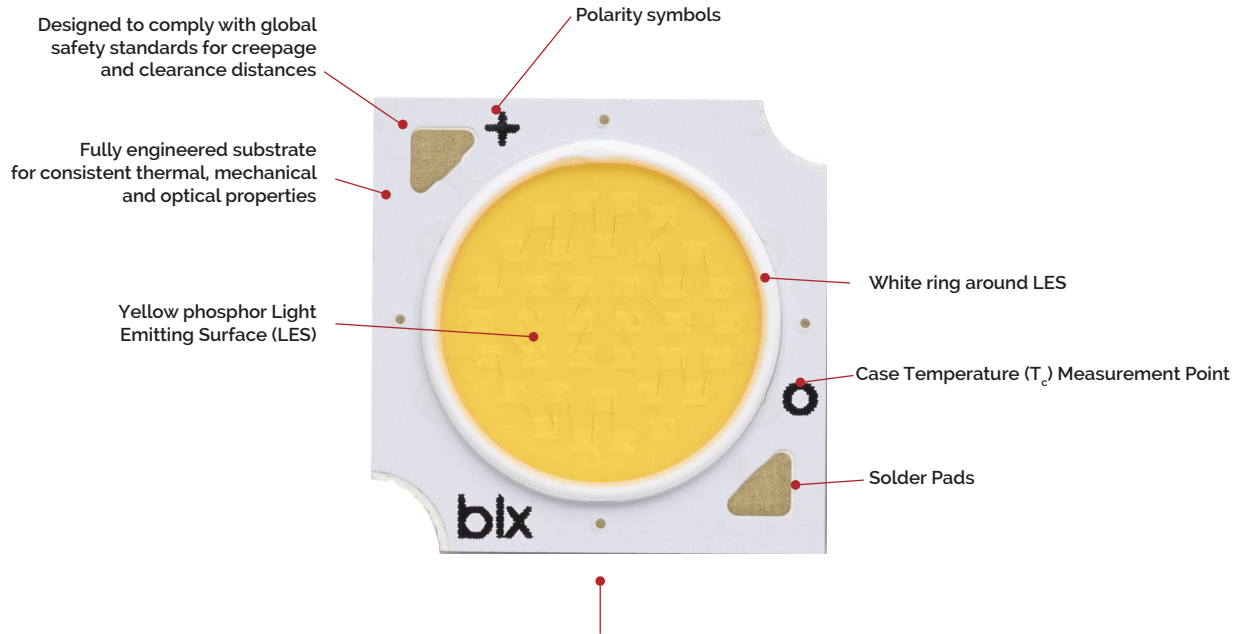

Note: Part number and lot codes are scribed on back of array

Product Nomenclature

The part number designation for Bridgelux Vero LED arrays is explained as follows:

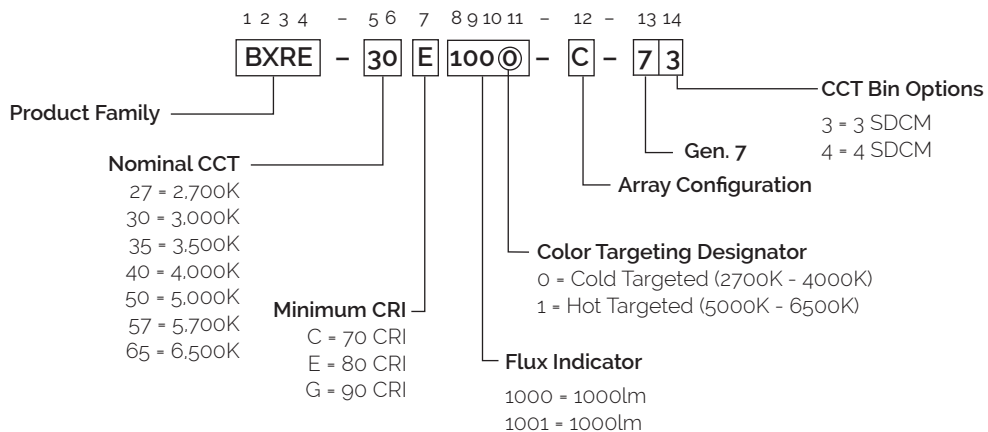

Product Selection Guide

The following product configurations are available:

Table 1: Selection Guide, Pulsed Measurement Data ($T_j = T_c = 25^\circ\text{C}$)

Part Number	Nominal CCT ¹ (K)	CRI ²	Nominal Drive Current ³ (mA)	Typical Pulsed Flux ^{4,5,6} $T_c = 25^\circ\text{C}$ (lm)	Minimum Pulsed Flux ^{6,7} $T_c = 25^\circ\text{C}$ (lm)	Typical V_f (V)	Typical Power (W)	Typical Efficacy (lm/W)
BXRE-27E1000-B-7X	2700	80	270	1348	1190	35.0	9.5	143
BXRE-27E1000-C-7X	2700	80	360	1797	1581	35.0	12.6	143
BXRE-27G1000-B-7X	2700	90	270	1124	992	35.0	9.5	119
BXRE-27G1000-C-7X	2700	90	360	1498	1318	35.0	12.6	119
BXRE-30E1000-B-7X	3000	80	270	1418	1240	35.0	9.5	150
BXRE-30E1000-C-7X	3000	80	360	1890	1647	35.0	12.6	150
BXRE-30G1000-B-7X	3000	90	270	1166	1029	35.0	9.5	123
BXRE-30G1000-C-7X	3000	90	360	1554	1367	35.0	12.6	123
BXRE-35E1000-B-7X	3500	80	270	1447	1277	35.0	9.5	153
BXRE-35E1000-C-7X	3500	80	360	1928	1697	35.0	12.6	153
BXRE-35G1000-B-7X	3500	90	270	1208	1066	35.0	9.5	128
BXRE-35G1000-C-7X	3500	90	360	1610	1417	35.0	12.6	128
BXRE-40E1000-B-7X	4000	80	270	1461	1290	35.0	9.5	155
BXRE-40E1000-C-7X	4000	80	360	1947	1713	35.0	12.6	155
BXRE-40G1000-B-7X	4000	90	270	1250	1104	35.0	9.5	132
BXRE-40G1000-C-7X	4000	90	360	1666	1466	35.0	12.6	132
BXRE-50C1001-B-74	5000	70	270	1601	1414	35.0	9.5	169
BXRE-50C1001-C-74	5000	70	360	2134	1878	35.0	12.6	169
BXRE-50E1001-B-74	5000	80	270	1505	1329	35.0	9.5	159
BXRE-50E1001-C-74	5000	80	360	2006	1765	35.0	12.6	159
BXRE-50G1001-B-74	5000	90	270	1281	1131	35.0	9.5	135
BXRE-50G1001-C-74	5000	90	360	1707	1502	35.0	12.6	135
BXRE-57C1001-B-74	5700	70	270	1545	1364	35.0	9.5	163
BXRE-57C1001-C-74	5700	70	360	2059	1812	35.0	12.6	163
BXRE-57E1001-B-74	5700	80	270	1531	1352	35.0	9.5	162
BXRE-57E1001-C-74	5700	80	360	2040	1796	35.0	12.6	162
BXRE-65C1001-B-74	6500	70	270	1573	1389	35.0	9.5	166
BXRE-65C1001-C-74	6500	70	360	2097	1845	35.0	12.6	166
BXRE-65E1001-B-74	6500	80	270	1559	1376	35.0	9.5	165
BXRE-65E1001-C-74	6500	80	360	2078	1829	35.0	12.6	165

Notes for Tables 1:

1. Nominal CCT as defined by ANSI C78.377-2011. Products with CCTs 5000K-6500K are hot targeted to 85°C .
2. CRI values are minimums. Minimum R_g value for 80 CRI products is 0, the minimum R_g values for 90 CRI products is 50.
3. Drive current is referred to as nominal drive current.
4. Products tested under pulsed condition (10ms pulse width) at nominal test current where T_j (junction temperature) = T_c (case temperature) = 25°C .
5. Typical performance values are provided as a reference only and are not a guarantee of performance.
6. Bridgelux maintains a $\pm 7\%$ tolerance on flux measurements.
7. Minimum flux values at the nominal test current are guaranteed by 100% test.

Product Selection Guide

Table 2: Selection Guide, Stabilized DC Performance ($T_c = 85^\circ\text{C}$)^{4,5}

Part Number	Nominal CCT ¹ (K)	CRI ²	Nominal Drive Current ³ (mA)	Typical DC Flux ^{4,5} $T_c = 85^\circ\text{C}$ (lm)	Minimum DC Flux ⁶ $T_c = 85^\circ\text{C}$ (lm)	Typical V_f (V)	Typical Power (W)	Typical Efficacy (lm/W)
BXRE-27E1000-B-7X	2700	80	270	1214	1071	34.0	9.2	132
BXRE-27E1000-C-7X	2700	80	360	1617	1423	34.0	12.3	132
BXRE-27G1000-B-7X	2700	90	270	1011	893	34.0	9.2	110
BXRE-27G1000-C-7X	2700	90	360	1348	1186	34.0	12.3	110
BXRE-30E1000-B-7X	3000	80	270	1276	1116	34.0	9.2	139
BXRE-30E1000-C-7X	3000	80	360	1701	1483	34.0	12.3	139
BXRE-30G1000-B-7X	3000	90	270	1049	926	34.0	9.2	114
BXRE-30G1000-C-7X	3000	90	360	1398	1231	34.0	12.3	114
BXRE-35E1000-B-7X	3500	80	270	1302	1149	34.0	9.2	142
BXRE-35E1000-C-7X	3500	80	360	1735	1527	34.0	12.3	142
BXRE-35G1000-B-7X	3500	90	270	1087	960	34.0	9.2	118
BXRE-35G1000-C-7X	3500	90	360	1449	1275	34.0	12.3	118
BXRE-40E1000-B-7X	4000	80	270	1315	1161	34.0	9.2	143
BXRE-40E1000-C-7X	4000	80	360	1752	1542	34.0	12.3	143
BXRE-40G1000-B-7X	4000	90	270	1125	993	34.0	9.2	122
BXRE-40G1000-C-7X	4000	90	360	1499	1320	34.0	12.3	122
BXRE-50C1001-B-74	5000	70	270	1441	1272	34.0	9.2	157
BXRE-50C1001-C-74	5000	70	360	1921	1690	34.0	12.3	157
BXRE-50E1001-B-74	5000	80	270	1355	1196	34.0	9.2	147
BXRE-50E1001-C-74	5000	80	360	1805	1589	34.0	12.3	147
BXRE-50G1001-B-74	5000	90	270	1153	1018	34.0	9.2	125
BXRE-50G1001-C-74	5000	90	360	1537	1352	34.0	12.3	125
BXRE-57C1001-B-74	5700	70	270	1390	1228	34.0	9.2	151
BXRE-57C1001-C-74	5700	70	360	1853	1631	34.0	12.3	151
BXRE-57E1001-B-74	5700	80	270	1378	1216	34.0	9.2	150
BXRE-57E1001-C-74	5700	80	360	1836	1616	34.0	12.3	150
BXRE-65C1001-B-74	6500	70	270	1416	1250	34.0	9.2	154
BXRE-65C1001-C-74	6500	70	360	1887	1661	34.0	12.3	154
BXRE-65E1001-B-74	6500	80	270	1403	1239	34.0	9.2	153
BXRE-65E1001-C-74	6500	80	360	1870	1646	34.0	12.3	153

Notes for Tables 2:

- Nominal CCT as defined by ANSI C78.377-2011. Products with a CCT of 5000K-6500K are hot targeted to 85°C.
- CRI values are minimums. Minimum Rg value for 80 CRI products is 0, the minimum Rg values for 90 CRI products is 50.
- Drive current is referred to as nominal drive current.
- Typical stabilized DC performance values are provided as reference only and are not a guarantee of performance.
- Typical performance is estimated based on operation under DC (direct current) with LED array mounted onto a heat sink with thermal interface material and the case temperature maintained at 85°C. Based on Bridgelux test setup, values may vary depending on the thermal design of the luminaire and/or the exposed environment to which the product is subjected.
- Minimum flux values at elevated temperatures are provided for reference only and are not guaranteed by 100% production testing. Based on Bridgelux test setup, values may vary depending on the thermal design of the luminaire and/or the exposed environment to which the product is subjected.

Performance at Commonly Used Drive Currents

V Series LED arrays are tested to the specifications shown using the nominal drive currents in Table 1. V Series may also be driven at other drive currents dependent on specific application design requirements. The performance at any drive current can be derived from the current vs. voltage characteristics shown in Figures 1 & 2 and the flux vs. current characteristics shown in Figures 3 & 4. The performance at commonly used drive currents is summarized in Table 3.

Table 3: Product Performance at Commonly Used Drive Currents

Part Number	CRI	Drive Current ¹ (mA)	Typical V_f $T_c = 25^\circ\text{C}$ (V)	Typical Power $T_c = 25^\circ\text{C}$ (W)	Typical Flux ² $T_c = 25^\circ\text{C}$ (lm)	Typical DC Flux ³ $T_c = 85^\circ\text{C}$ (lm)	Typical Efficacy $T_c = 25^\circ\text{C}$ (lm/W)
BXRE-27E1000-B-7X	80	135	33.3	4.5	719	646	160
		180	33.8	6.1	942	845	155
		270	35.0	9.5	1348	1214	143
		405	36.4	14.8	1978	1760	134
		540	37.8	20.4	2534	2243	124
BXRE-27E1000-C-7X	80	180	33.3	6.0	955	853	160
		240	33.8	8.1	1252	1112	154
		360	35.0	12.6	1797	1617	143
		540	36.4	19.7	2617	2273	133
		720	37.7	27.1	3343	2861	123
BXRE-27G1000-B-7X	90	135	33.3	4.5	599	538	133
		180	33.8	6.1	785	704	129
		270	35.0	9.5	1124	1011	119
		405	36.4	14.8	1648	1466	112
		540	37.8	20.4	2112	1869	104
BXRE-27G1000-C-7X	90	180	33.3	6.0	796	710	133
		240	33.8	8.1	1043	927	128
		360	35.0	12.6	1498	1348	119
		540	36.4	19.7	2181	1894	111
		720	37.7	27.1	2786	2385	103
BXRE-30E1000-B-7X	80	135	33.3	4.5	755	679	168
		180	33.8	6.1	990	888	163
		270	35.0	9.5	1418	1276	150
		405	36.4	14.8	2080	1850	141
		540	37.8	20.4	2664	2358	131
BXRE-30E1000-C-7X	80	180	33.3	6.0	1005	897	168
		240	33.8	8.1	1316	1169	162
		360	35.0	12.6	1890	1701	150
		540	36.4	19.7	2752	2391	140
		720	37.7	27.1	3516	3009	130

Notes for Table 3:

1. Alternate drive currents in Table 3 are provided for reference only and are not a guarantee of performance.
2. Bridgelux maintains a $\pm 7\%$ tolerance on flux measurements.
3. Typical stabilized DC performance values are provided as reference only and are not a guarantee of performance.

Performance at Commonly Used Drive Currents

Table 3: Product Performance at Commonly Used Drive Currents (Continued)

Part Number	CRI	Drive Current ¹ (mA)	Typical V_f $T_c = 25^\circ\text{C}$ (V)	Typical Power $T_c = 25^\circ\text{C}$ (W)	Typical Flux ² $T_c = 25^\circ\text{C}$ (lm)	Typical DC Flux ³ $T_c = 85^\circ\text{C}$ (lm)	Typical Efficacy $T_c = 25^\circ\text{C}$ (lm/W)
BXRE-30G1000-B-7X	90	135	33.3	4.5	621	558	138
		180	33.8	6.1	815	731	134
		270	35.0	9.5	1166	1049	123
		405	36.4	14.8	1710	1521	116
		540	37.8	20.4	2191	1939	107
BXRE-30G1000-C-7X	90	180	33.3	6.0	826	737	138
		240	33.8	8.1	1082	961	133
		360	35.0	12.6	1554	1398	123
		540	36.4	19.7	2262	1965	115
		720	37.7	27.1	2890	2474	107
BXRE-35E1000-B-7X	80	135	33.3	4.5	771	693	172
		180	33.8	6.1	1011	907	166
		270	35.0	9.5	1447	1302	153
		405	36.4	14.8	2122	1888	144
		540	37.8	20.4	2719	2407	133
BXRE-35E1000-C-7X	80	180	33.3	6.0	1025	915	171
		240	33.8	8.1	1343	1193	165
		360	35.0	12.6	1928	1735	153
		540	36.4	19.7	2808	2439	143
		720	37.7	27.1	3586	3070	132
BXRE-35G1000-B-7X	90	135	33.3	4.5	644	578	143
		180	33.8	6.1	844	757	139
		270	35.0	9.5	1208	1087	128
		405	36.4	14.8	1772	1576	120
		540	37.8	20.4	2270	2009	111
BXRE-35G1000-C-7X	90	180	33.3	6.0	856	764	143
		240	33.8	8.1	1121	996	138
		360	35.0	12.6	1610	1449	128
		540	36.4	19.7	2344	2037	119
		720	37.7	27.1	2995	2563	110
BXRE-40E1000-B-7X	80	135	33.3	4.5	778	700	173
		180	33.8	6.1	1021	915	168
		270	35.0	9.5	1461	1315	155
		405	36.4	14.8	2143	1906	145
		540	37.8	20.4	2745	2430	135
BXRE-40E1000-C-7X	80	180	33.3	6.0	1035	924	173
		240	33.8	8.1	1356	1205	167
		360	35.0	12.6	1947	1752	155
		540	36.4	19.7	2835	2463	144
		720	37.7	27.1	3621	3100	133
BXRE-40G1000-B-7X	90	135	33.3	4.5	666	599	148
		180	33.8	6.1	873	783	143
		270	35.0	9.5	1250	1125	132
		405	36.4	14.8	1834	1631	124
		540	37.8	20.4	2349	2079	115

Notes for Table 3:

1. Alternate drive currents in Table 3 are provided for reference only and are not a guarantee of performance.
2. Bridgelux maintains a $\pm 7\%$ tolerance on flux measurements.
3. Typical stabilized DC performance values are provided as reference only and are not a guarantee of performance.

Performance at Commonly Used Drive Currents

Table 3: Product Performance at Commonly Used Drive Currents (Continued)

Part Number	CRI	Drive Current ¹ (mA)	Typical V_f $T_c = 25^\circ\text{C}$ (V)	Typical Power $T_c = 25^\circ\text{C}$ (W)	Typical Flux ² $T_c = 25^\circ\text{C}$ (lm)	Typical DC Flux ³ $T_c = 85^\circ\text{C}$ (lm)	Typical Efficacy $T_c = 25^\circ\text{C}$ (lm/W)
BXRE-40G1000-C-7X	90	180	33.3	6.0	886	790	148
		240	33.8	8.1	1160	1031	143
		360	35.0	12.6	1666	1499	132
		540	36.4	19.7	2426	2108	123
		720	37.7	27.1	3099	2653	114
BXRE-50C1001-B-74	70	135	33.3	4.5	853	767	190
		180	33.8	6.1	1119	1003	184
		270	35.0	9.5	1601	1441	169
		405	36.4	14.8	2349	2090	159
		540	37.8	20.4	3009	2664	148
BXRE-50C1001-C-74	70	180	33.3	6.0	1135	1012	190
		240	33.8	8.1	1486	1321	183
		360	35.0	12.6	2134	1921	169
		540	36.4	19.7	3108	2700	158
		720	37.7	27.1	3970	3398	146
BXRE-50E1001-B-74	80	135	33.3	4.5	802	721	179
		180	33.8	6.1	1052	943	173
		270	35.0	9.5	1505	1355	159
		405	36.4	14.8	2208	1964	150
		540	37.8	20.4	2829	2504	139
BXRE-50E1001-C-74	80	180	33.3	6.0	1067	952	178
		240	33.8	8.1	1397	1241	172
		360	35.0	12.6	2006	1805	159
		540	36.4	19.7	2921	2538	149
		720	37.7	27.1	3731	3194	138
BXRE-50G1001-B-74	90	135	33.3	4.5	683	613	152
		180	33.8	6.1	895	803	147
		270	35.0	9.5	1281	1153	135
		405	36.4	14.8	1879	1672	127
		540	37.8	20.4	2408	2131	118
BXRE-50G1001-C-74	90	180	33.3	6.0	908	810	152
		240	33.8	8.1	1189	1056	146
		360	35.0	12.6	1707	1537	135
		540	36.4	19.7	2486	2160	126
		720	37.7	27.1	3176	2718	117
BXRE-57C1001-B-74	70	135	33.3	4.5	823	740	183
		180	33.8	6.1	1079	968	177
		270	35.0	9.5	1545	1390	163
		405	36.4	14.8	2267	2016	154
		540	37.8	20.4	2904	2570	142
BXRE-57C1001-C-74	70	180	33.3	6.0	1095	977	183
		240	33.8	8.1	1434	1274	177
		360	35.0	12.6	2059	1853	163
		540	36.4	19.7	2998	2605	153
		720	37.7	27.1	3830	3279	141

Notes for Table 3:

1. Alternate drive currents in Table 3 are provided for reference only and are not a guarantee of performance.
2. Bridgelux maintains a $\pm 7\%$ tolerance on flux measurements.
3. Typical stabilized DC performance values are provided as reference only and are not a guarantee of performance.

Performance at Commonly Used Drive Currents

Table 3: Product Performance at Commonly Used Drive Currents (Continued)

Part Number	CRI	Drive Current ¹ (mA)	Typical V_f $T_c = 25^\circ\text{C}$ (V)	Typical Power $T_c = 25^\circ\text{C}$ (W)	Typical Flux ² $T_c = 25^\circ\text{C}$ (lm)	Typical DC Flux ³ $T_c = 85^\circ\text{C}$ (lm)	Typical Efficacy $T_c = 25^\circ\text{C}$ (lm/W)
BXRE-57E1001-B-74	80	135	33.3	4.5	816	733	182
		180	33.8	6.1	1070	959	176
		270	35.0	9.5	1531	1378	162
		405	36.4	14.8	2246	1998	152
		540	37.8	20.4	2877	2547	141
BXRE-57E1001-C-74	80	180	33.3	6.0	1085	968	181
		240	33.8	8.1	1421	1263	175
		360	35.0	12.6	2040	1836	162
		540	36.4	19.7	2971	2581	151
		720	37.7	27.1	3795	3249	140
BXRE-65C1001-B-74	70	135	33.3	4.5	838	753	187
		180	33.8	6.1	1099	986	180
		270	35.0	9.5	1573	1416	166
		405	36.4	14.8	2308	2053	156
		540	37.8	20.4	2957	2617	145
BXRE-65C1001-C-74	70	180	33.3	6.0	1115	995	186
		240	33.8	8.1	1460	1297	180
		360	35.0	12.6	2097	1887	166
		540	36.4	19.7	3053	2652	155
		720	37.7	27.1	3900	3338	144
BXRE-65E1001-B-74	80	135	33.3	4.5	831	747	185
		180	33.8	6.1	1089	977	179
		270	35.0	9.5	1559	1403	165
		405	36.4	14.8	2287	2035	155
		540	37.8	20.4	2930	2593	144
BXRE-65E1001-C-74	80	180	33.3	6.0	1105	986	185
		240	33.8	8.1	1447	1286	178
		360	35.0	12.6	2078	1870	165
		540	36.4	19.7	3026	2629	154
		720	37.7	27.1	3865	3309	142

Notes for Table 3:

1. Alternate drive currents in Table 3 are provided for reference only and are not a guarantee of performance.
2. Bridgelux maintains a $\pm 7\%$ tolerance on flux measurements.
3. Typical stabilized DC performance values are provided as reference only and are not a guarantee of performance.

Electrical Characteristics

Table 4: Electrical Characteristics

Part Number	Drive Current (mA)	Forward Voltage Pulsed, $T_c = 25^\circ\text{C}$ (V) ^{1, 2, 3, 8}			Typical Coefficient of Forward Voltage ⁴ $\Delta V_f / \Delta T_c$ (mV/ $^\circ\text{C}$)	Typical Thermal Resistance Junction to Case ^{5,6} R_{j-c} ($^\circ\text{C}/\text{W}$)	Driver Selection Voltages ⁷ (V)	
		Minimum	Typical	Maximum			V_f Min. Hot $T_c = 105^\circ\text{C}$ (V)	V_f Max. Cold $T_c = -40^\circ\text{C}$ (V)
BXRE-xxx100x-B-7x	270	32.4	35.0	37.6	-16.1	0.49	31.1	38.7
	540	34.9	37.8	40.6	-16.1	0.56	33.6	41.6
BXRE-xxx100x-C-7x	360	32.4	35.0	37.6	-16.1	0.37	31.1	38.7
	720	34.9	37.7	40.5	-16.1	0.45	33.6	41.6

Notes for Table 4:

- Parts are tested in pulsed conditions, $T_c = 25^\circ\text{C}$. Pulse width is 10ms.
- Voltage minimum and maximum are provided for reference only and are not a guarantee of performance.
- Bridgelux maintains a tester tolerance of $\pm 0.10\text{V}$ on forward voltage measurements.
- Typical coefficient of forward voltage tolerance is $\pm 0.1\text{mV}$ for nominal current.
- Thermal resistance values are based from test data of a 3000K 80 CRI product.
- Thermal resistance value was calculated using total electrical input power; optical power was not subtracted from input power. The thermal interface material used during testing is not included in the thermal resistance value.
- V_f min hot and max cold values are provided as reference only and are not guaranteed by test. These values are provided to aid in driver design and selection over the operating range of the product.
- This product has been designed and manufactured per IEC 62031:2014. This product has passed dielectric withstand voltage testing at 1120 V. The working voltage designated for the insulation is 60V d.c. The maximum allowable voltage across the array must be determined in the end product application.

Absolute Maximum Ratings

Table 5: Maximum Ratings

Parameter	Maximum Rating	
LED Junction Temperature (T_j)	125°C	
Storage Temperature	-40°C to +105°C	
Operating Case Temperature ¹ (T_c)	105°C	
Soldering Temperature ²	350°C or lower for a maximum of 10 seconds	
	BXRE-xxx100x-B-7x	BXRE-xxx100x-C-7x
Maximum Drive Current ³	540mA	720mA
Maximum Peak Pulsed Drive Current ⁴	771mA	1029mA
Maximum Reverse Voltage ⁵	-60V	-60V

Notes for Table 5:

1. For IEC 62717 requirement, please consult your Bridgelux sales representative.
2. Refer to Bridgelux Application Note AN41: Handling and Assembly of Bridgelux V Series LED Arrays.
3. Arrays may be driven at higher currents however lumen maintenance may be reduced.
4. Bridgelux recommends a maximum duty cycle of 10% and pulse width of 20 ms when operating LED Arrays at maximum peak pulsed current specified. Maximum peak pulsed currents indicate values where LED Arrays can be driven without catastrophic failures.
5. Light emitting diodes are not designed to be driven in reverse voltage and will not produce light under this condition. Maximum rating provided for reference only.

Performance Curves

Figure 1: V10B Drive Current vs. Voltage ($T_j = T_c = 25^\circ\text{C}$)

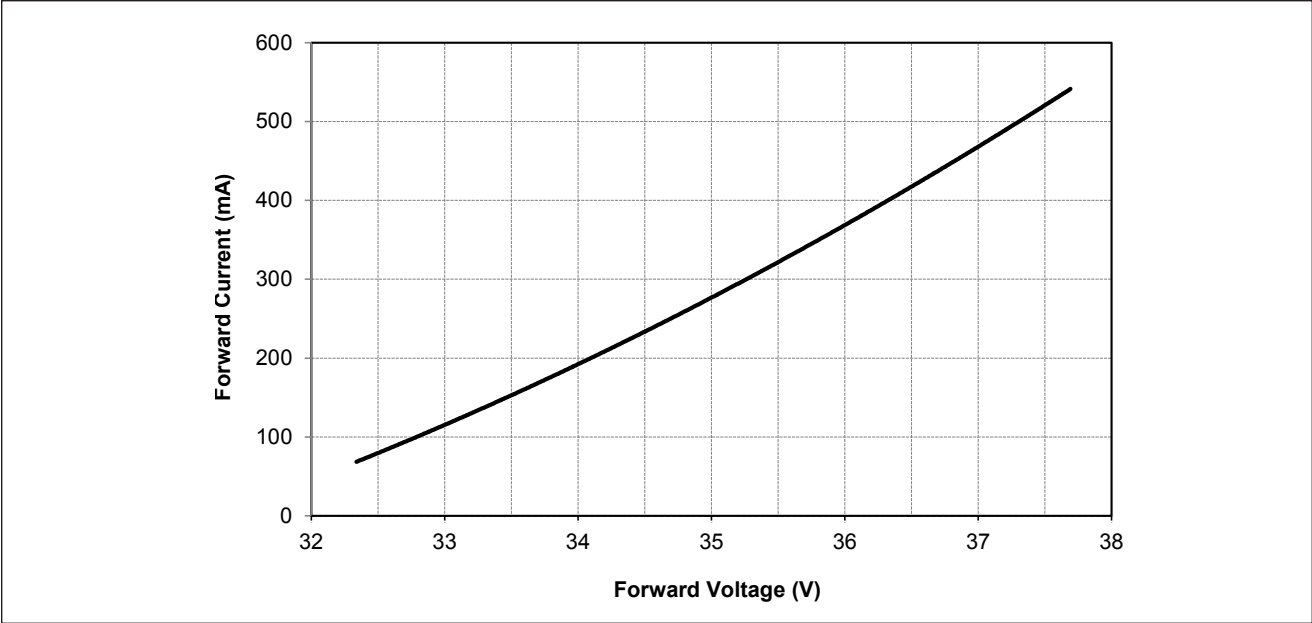
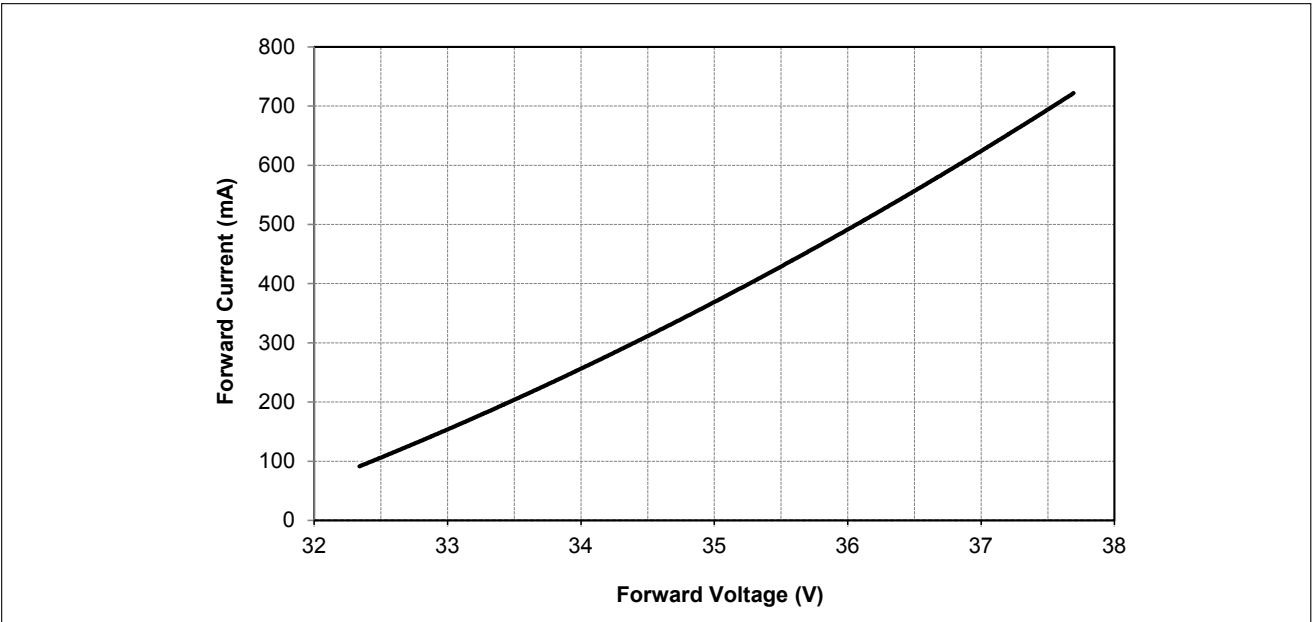

Figure 2: V10C Drive Current vs. Voltage ($T_j = T_c = 25^\circ\text{C}$)



Performance Curves

Figure 3: V10B Typical Relative Flux vs. Current ($T_j = T_c = 25^\circ\text{C}$)

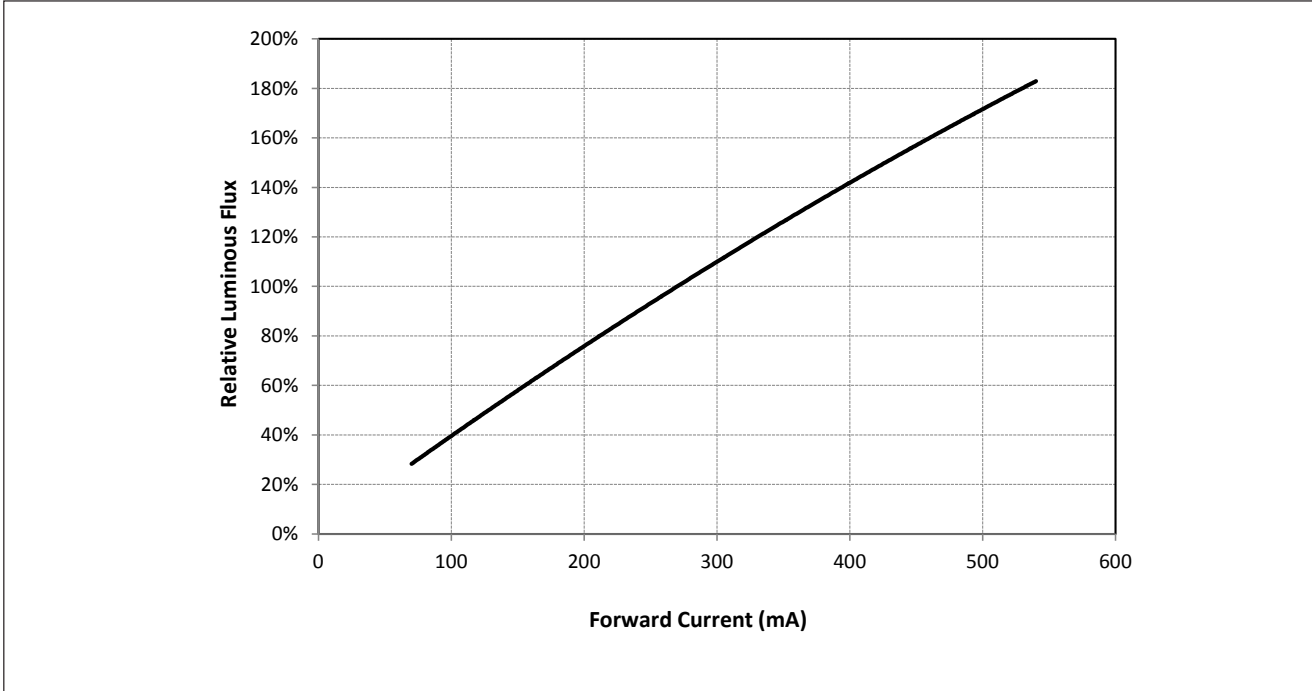
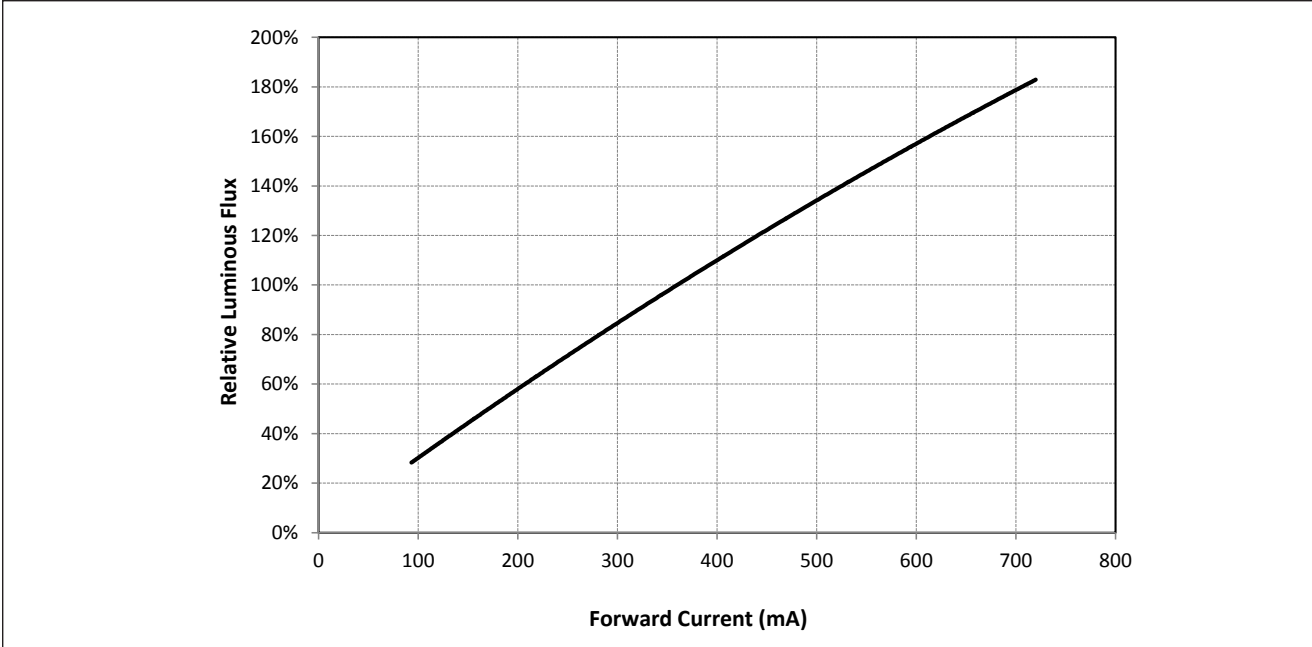

Figure 4: V10C Typical Relative Flux vs. Current ($T_j = T_c = 25^\circ\text{C}$)



Note for Figures 3 & 4:
1. Bridgelux does not recommend driving high power LEDs at low currents. Doing so may produce unpredictable results. Pulse width modulation (PWM) is recommended for dimming effects.

Performance Curves

Figure 5: Typical DC Flux vs. Case Temperature

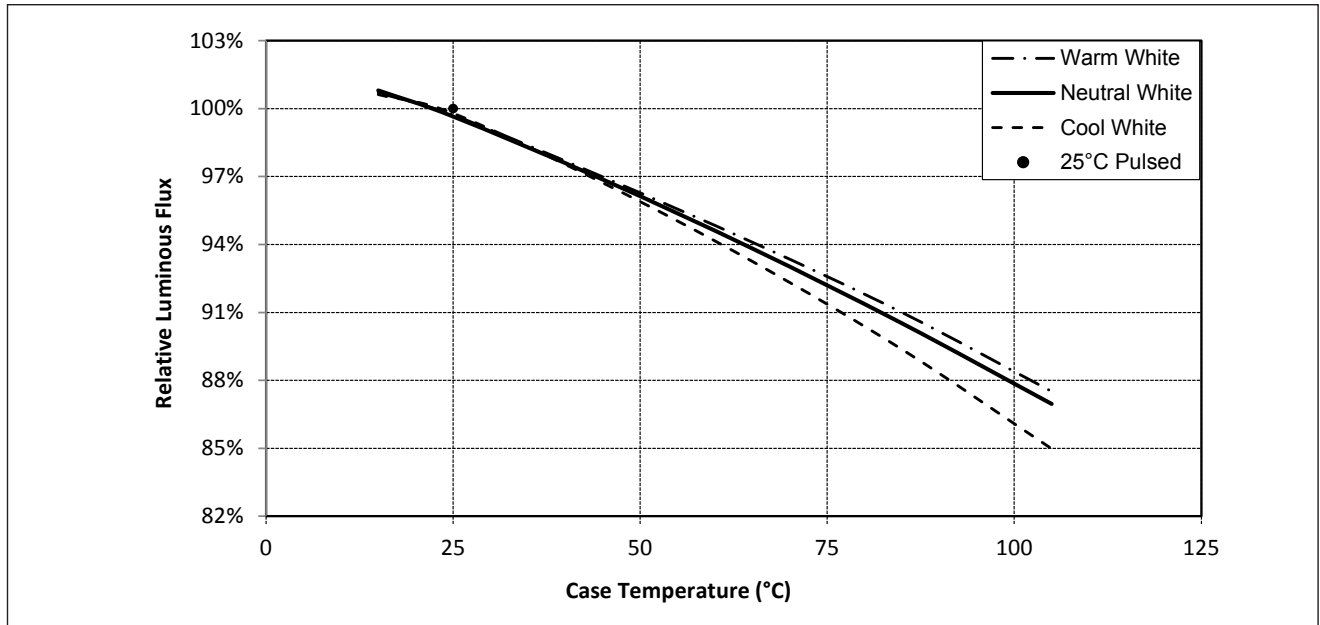
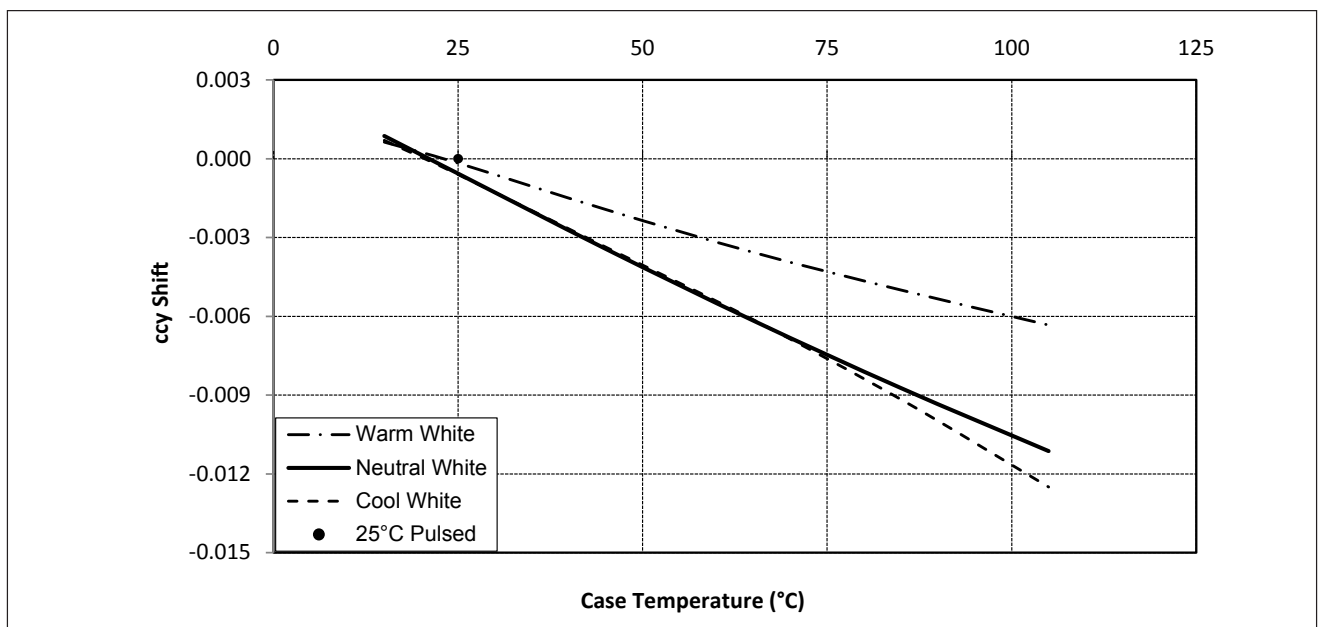

Figure 6: Typical DC ccy Shift vs. Case Temperature



Notes for Figures 5 & 6:

1. Characteristics shown for warm white based on 3000K and 80 CRI.
2. Characteristics shown for neutral white based on 4000K and 80 CRI.
3. Characteristics shown for cool white based on 5000K and 70 CRI.
4. For other color SKUs, the shift in color will vary. Please contact your Bridgelux Sales Representative for more information.

Performance Curves

Figure 7: Typical DC ccx Shift vs. Case Temperature

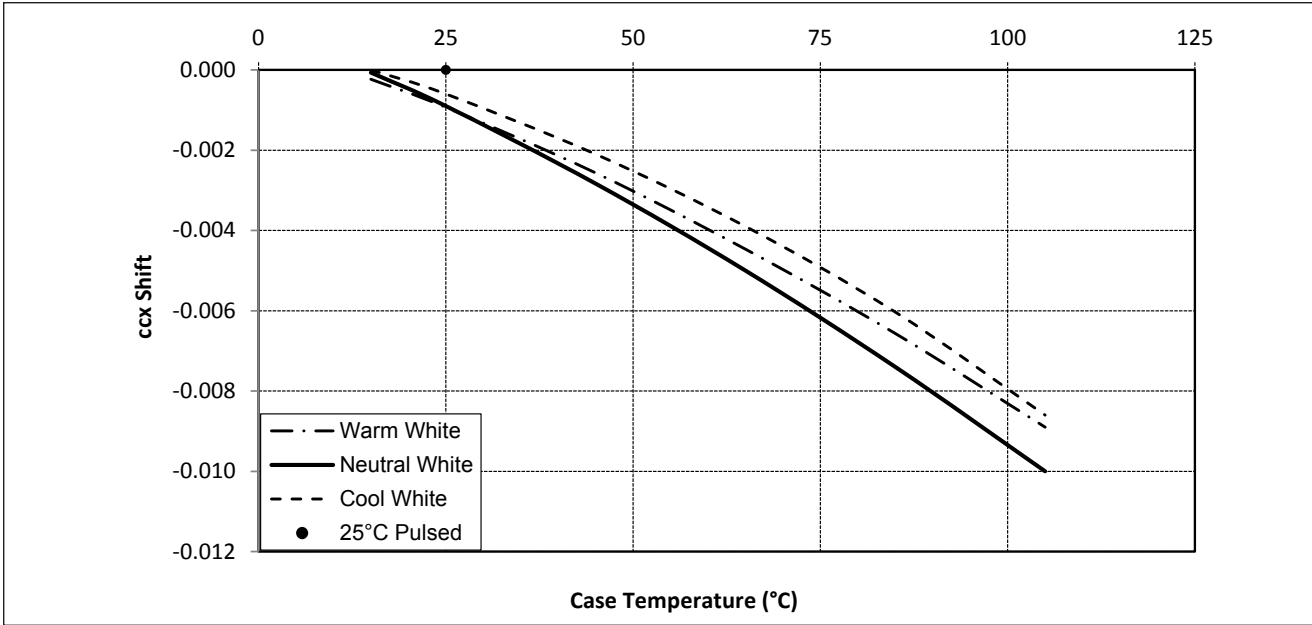

Notes for Figure 7:

1. Characteristics shown for warm white based on 3000K and 80 CRI.
2. Characteristics shown for neutral white based on 4000K and 80 CRI.
3. Characteristics shown for cool white based on 5000K and 70 CRI.
4. For other color SKUs, the shift in color will vary. Please contact your Bridgelux Sales Representative for more information.

Typical Radiation Pattern

Figure 8: Typical Spatial Radiation Pattern

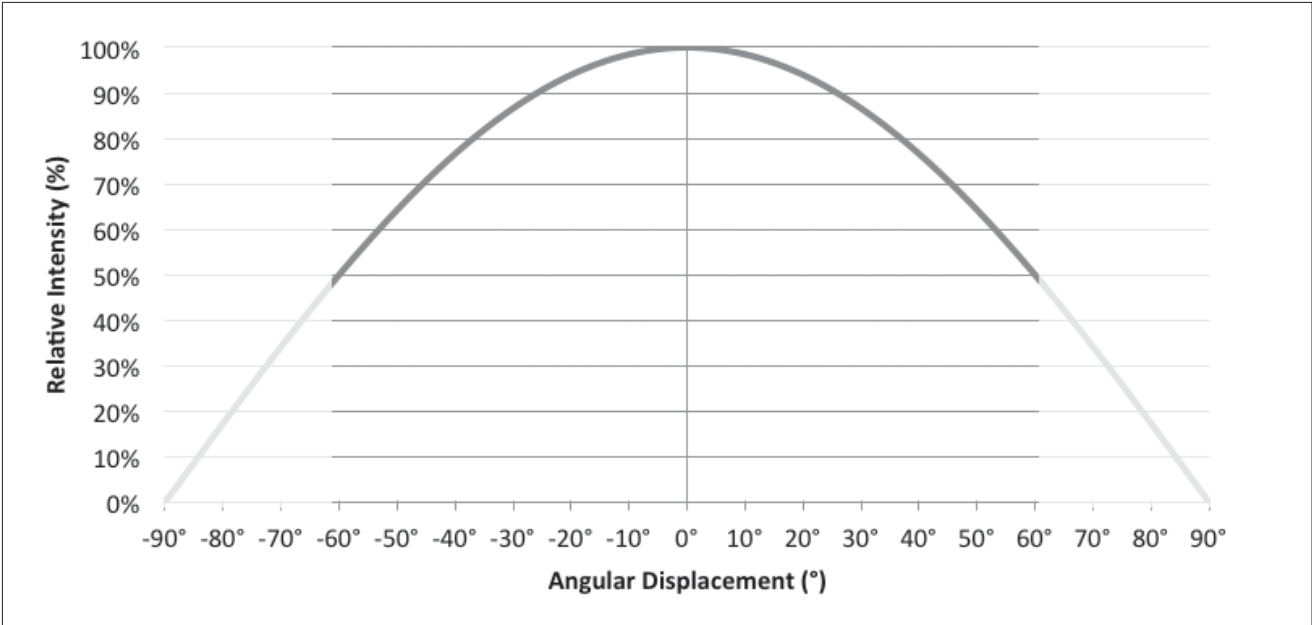

Note for Figure 8:

- 1. Typical viewing angle is 120°.
- 2. The viewing angle is defined as the off axis angle from the centerline where intensity is 1/2 of the peak value.

Figure 9: Typical Polar Radiation Pattern

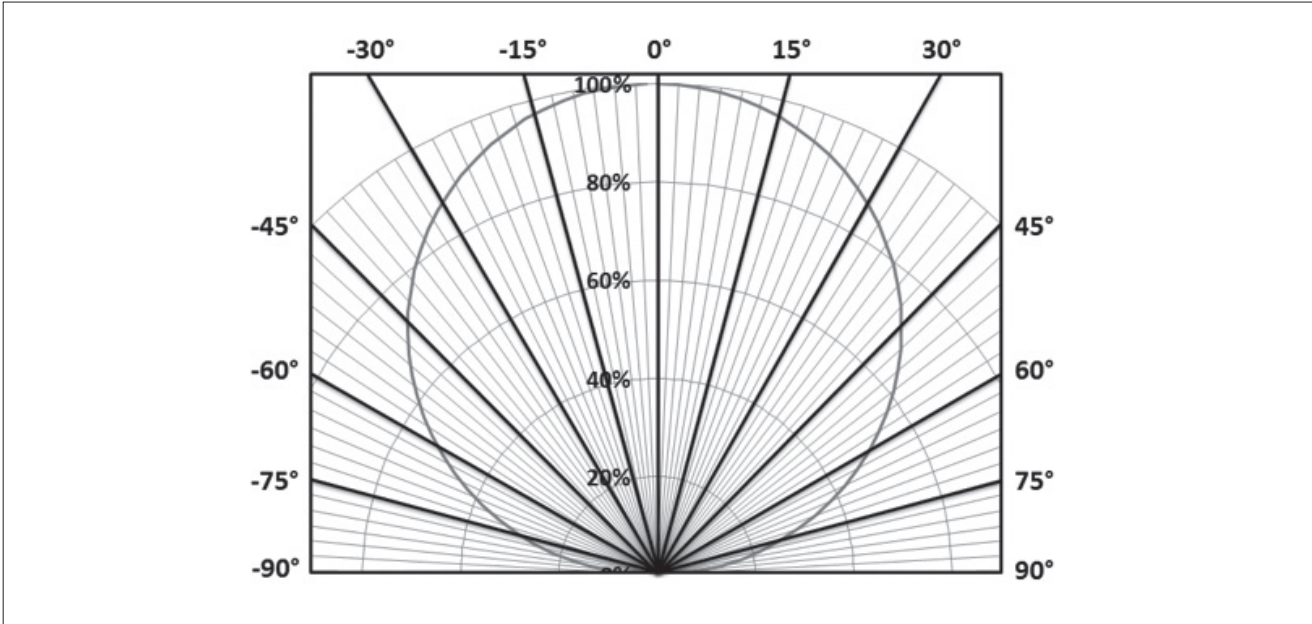

Typical Color Spectrum

Figure 10: Typical Color Spectrum

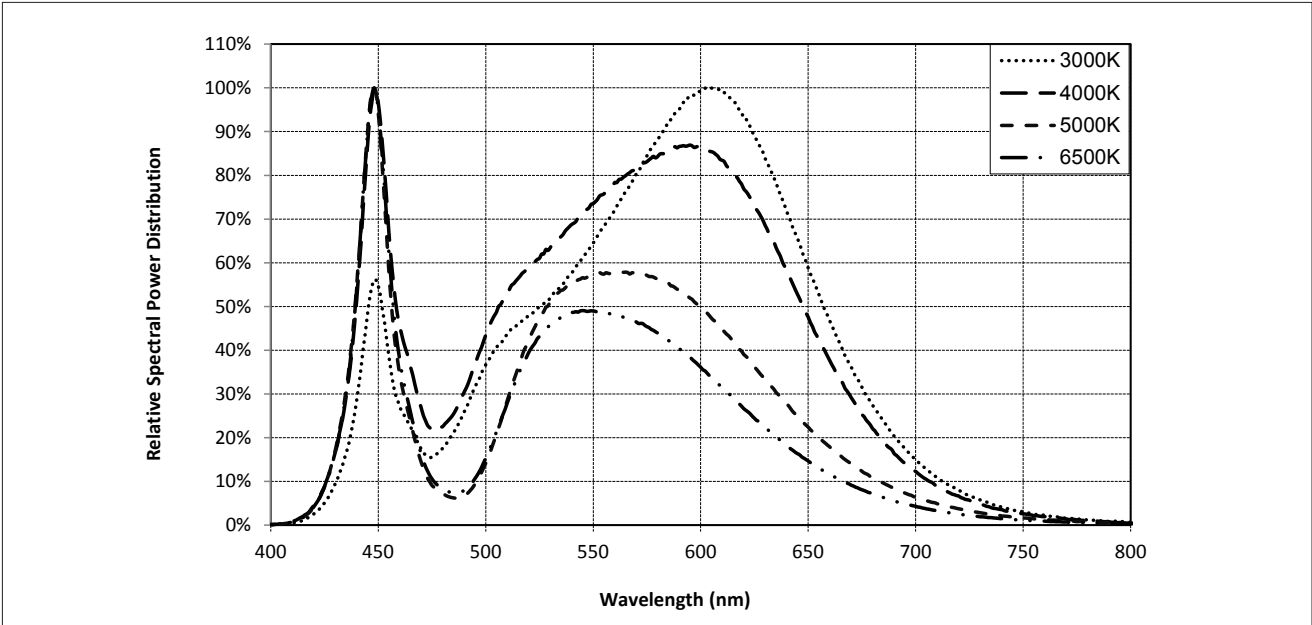

- Notes for Figure 10:
- 1. Color spectra measured at nominal current for $T_j = T_c = 25^\circ\text{C}$.
 - 2. Color spectra shown is 3000K and 80 CRI.
 - 3. Color spectra shown is 4000K and 80 CRI.
 - 4. Color spectra shown is 5000K and 70 CRI.
 - 4. Color spectra shown is 6500K and 70 CRI.

Mechanical Dimensions

Figure 11: V10 LED Array

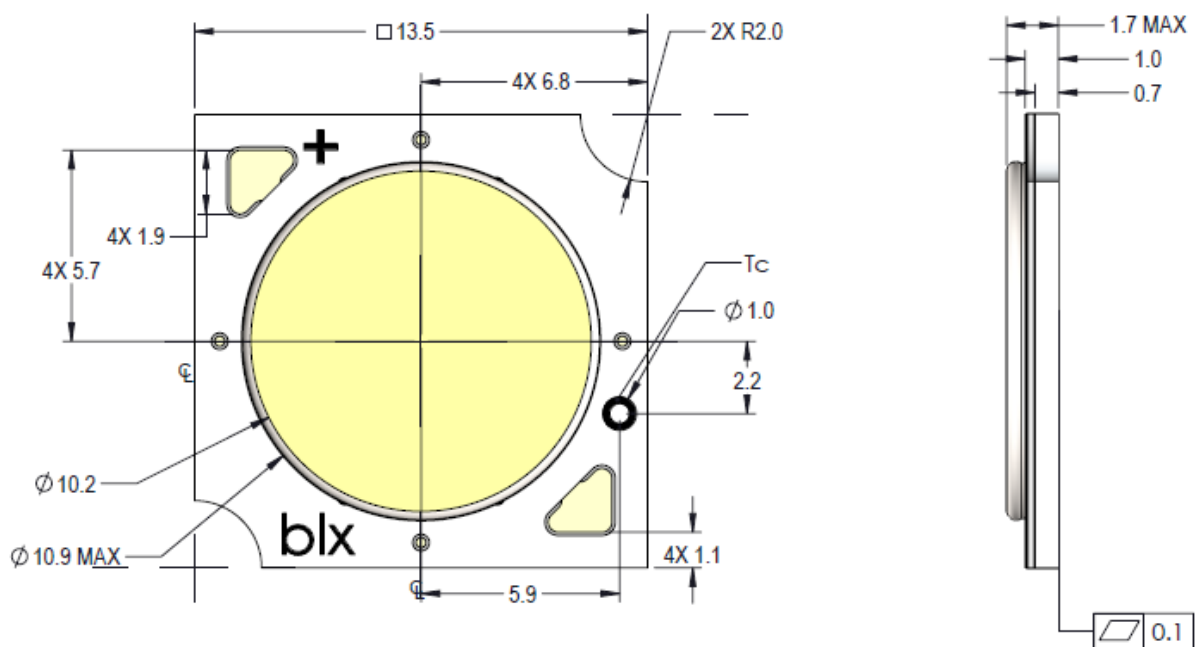

Notes for Figure 11:

1. Drawings are not to scale.
2. Drawing dimensions are in millimeters.
3. Unless otherwise specified, tolerances are $\pm 0.1\text{mm}$.
4. Mounting holes (2X) are for M2.5 screws.
5. Bridgelux recommends two tapped holes for mounting screws with $31.4 \pm 0.10\text{mm}$ center-to-center spacing.
6. Screws with flat shoulders (pan, dome, button, round, truss, mushroom) provide optimal torque control. Do NOT use flat, countersink, or raised head screws.
7. Solder pads and connector port are labeled "+" and "-" to denote positive and negative, respectively.
8. It is not necessary to provide electrical connections to both the solder pads and the connector port. Either set may be used depending on application specific design requirements.
9. Refer to Application Notes AN30 and AN31 for product handling, mounting and heat sink recommendations.
10. The optical center of the LED Array is nominally defined by the mechanical center of the array to a tolerance of $\pm 0.2\text{mm}$.
11. Bridgelux maintains a flatness of 0.10mm across the mounting surface of the array.

Color Binning Information

Figure 12: Graph of Warm and Neutral White Test Bins in xy Color Space

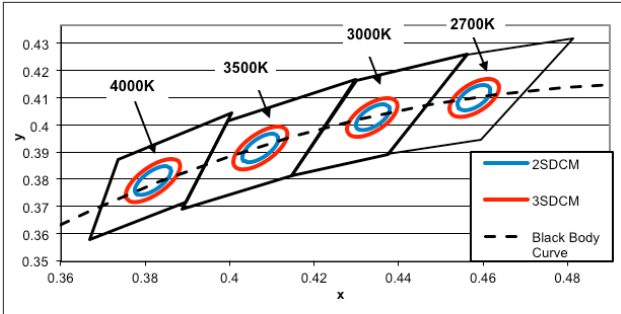

Note: Pulsed Test Conditions, $T_c = 25^\circ\text{C}$

Table 6: Warm and Neutral White xy Bin Coordinates and Associated Typical CCT

Bin Code	2700K	3000K	3500K	4000K
ANSI Bin (for reference only)	(2580K - 2870K)	(2870K - 3220K)	(3220K - 3710K)	(3710K - 4260K)
23 (3 SDCM)	(2651K - 2794K)	(2968K - 3136K)	(3369K - 3586K)	(3851K - 4130K)
22 (2 SDCM)	(2674K - 2769K)	(2995K - 3107K)	(3404K - 3548K)	(3895K - 4081K)
Center Point (x,y)	(0.4578, 0.4101)	(0.4338, 0.403)	(0.4073, 0.3917)	(0.3818, 0.3797)

Figure 13: Graph of Cool White Test Bins in xy Color Space

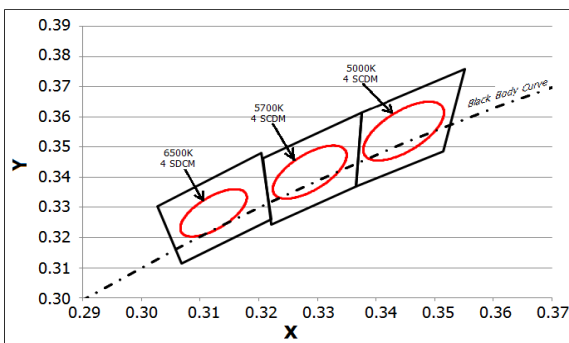

Note: Pulsed Test Conditions, $T_c = 25^\circ\text{C}$

Table 7: Cool White xy Bin Coordinates and Associated Typical CCT (product is hot targeted to $T_c = 85^\circ\text{C}$)

Bin Code	5000K	5700K	6500K
ANSI Bin (for reference only)	(4745K - 5311K)	(5312K - 6022K)	(6022K - 7042K)
4 (4 SDCM)	(4801K - 5282K)	(5829K - 5481K)	(6270K - 6765K)
Center Point (x,y)	(0.3447, 0.3553)	(0.3287, 0.3417)	(0.3123, 0.3282)

Packaging and Labeling

Figure 14: Drawing for V10 Packaging Tray

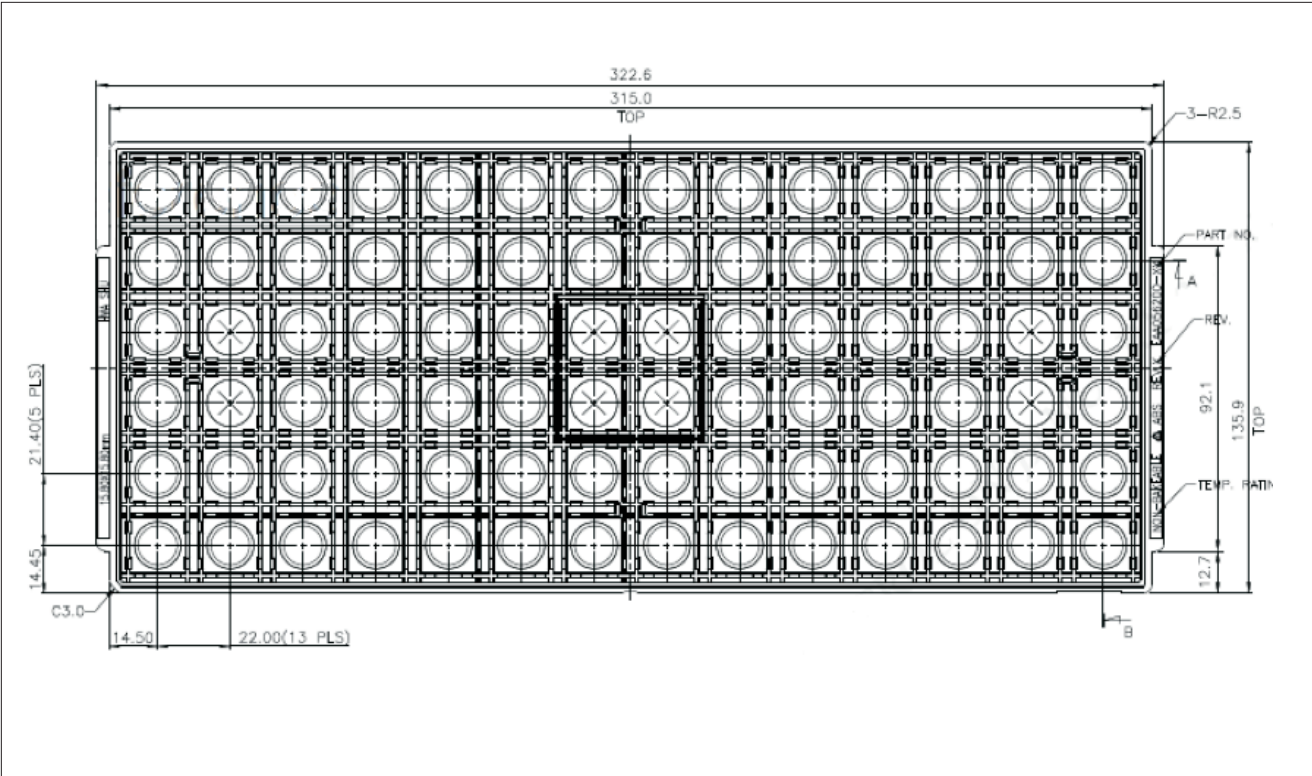

Notes for Figure 14:

1. Dimensions are in millimeters
2. Tolerances: XX - ± 0.25, XXX - ± 0.13, X'o' - ±0'30'
3. Trays are stackable without interference and will not stick together during unstacking operation

Packaging and Labeling

Figure 15: V10 Packaging and Labeling



Notes for Figure 15:

1. Each tray holds 60 COB Arrays, 10 trays are stacked and one empty tray placed on top to cover the top tray.
2. Stacked trays are to contain only 1 part number and be vacuum sealed in an anti-static bag and placed in its own individual box.
3. Each bag and box is to be labeled as shown above.

Figure 16: Gen. 7 Product Labeling

Bridgelux COB arrays have laser markings on the back side of the substrate to help with product identification. In addition to the product identification markings, Bridgelux COB arrays also contain markings for internal Bridgelux manufacturing use only. The image below shows which markings are for customer use and which ones are for Bridgelux internal use only. The Bridgelux internal manufacturing markings are subject to change without notice, however these will not impact the form, function or performance of the COB array.



Customer Use- 2D Barcode
Scannable barcode provides product part number and other Bridgelux internal production information.

Customer Use- Product part number ———— **30E200C 73**

Design Resources

Application Notes

Bridgelux has developed a comprehensive set of application notes and design resources to assist customers in successfully designing with the V Series product family of LED array products. For all available application notes visit www.bridgelux.com.

Optical Source Models

Optical source models and ray set files are available for all Bridgelux products. For a list of available formats, visit www.bridgelux.com.

3D CAD Models

Three dimensional CAD models depicting the product outline of all Bridgelux V Series LED arrays are available in both IGS and STEP formats. Please contact your Bridgelux sales representative for assistance.

LM80

LM80 testing is ongoing. Please contact your Bridgelux sales representative for more information.

Precautions

CAUTION: CHEMICAL EXPOSURE HAZARD

Exposure to some chemicals commonly used in luminaire manufacturing and assembly can cause damage to the LED array. Please consult Bridgelux Application Note AN31 for additional information.

CAUTION: EYE SAFETY

Eye safety classification for the use of Bridgelux V Series LED arrays is in accordance with specification IEC/TR 62778: Application of IEC 62471 for the assessment of blue light hazard to light sources and luminaires. V Series LED arrays are classified as Risk Group 2 (Moderate Risk) when operated at or below 2.5 times the nominal drive current. The Ethr value is 889.79 lux per IEC/TR 62778. Please use appropriate precautions. **Under many operating conditions the V Series LED arrays are classified as Risk Group 1, for more information please contact your Bridgelux sales representative.** It is important that employees working with LEDs are trained to use them safely.

CAUTION: RISK OF BURN

Do not touch the V Series LED array during operation. Allow the array to cool for a sufficient period of time before handling. The V Series LED array may reach elevated temperatures such that could burn skin when touched

CAUTION

CONTACT WITH LIGHT EMITTING SURFACE (LES)

Avoid any contact with the LES. Do not touch the LES of the LED array or apply stress to the LES (yellow phosphor resin area). Contact may cause damage to the LED array.

Optics and reflectors must not be mounted in contact with the LES (yellow phosphor resin area). Use the mechanical features of the LED array housing, edges and/or mounting holes to locate and secure optical devices as needed.

Disclaimers

MINOR PRODUCT CHANGE POLICY

The rigorous qualification testing on products offered by Bridgelux provides performance assurance. Slight cosmetic changes that do not affect form, fit, or function may occur as Bridgelux continues product optimization.

STANDARD TEST CONDITIONS

Unless otherwise stated, array testing is performed at the nominal drive current.

About Bridgelux: We Build Light That Transforms

At Bridgelux, we help companies, industries and people experience the power and possibility of light. Since 2002, we've designed LED solutions that are high performing, energy efficient, cost effective and easy to integrate. Our focus is on light's impact on human behavior, delivering products that create better environments, experiences and returns—both experiential and financial. And our patented technology drives new platforms for commercial and industrial luminaires.

For more information about the company, please visit
bridgelux.com
twitter.com/Bridgelux
facebook.com/Bridgelux
WeChat ID: BridgeluxInChina



101 Portola Avenue
Livermore, CA 94551
Tel (925) 583-8400
Fax (925) 583-8410
www.bridgelux.com

© 2016 Bridgelux, Inc. All rights reserved 2016. Product specifications are subject to change without notice. Bridgelux, the Bridgelux stylized logo design and Vero are registered trademarks, and Decor Series is a trademark of Bridgelux, Inc. All other trademarks are the property of their respective owners.

Bridgelux Gen 7 V10 Array Series Product Data Sheet DS100 Rev. C (07/2016)