

COLOUR	VOID POSITION	PLATING OPTION	PART NUMBER
BLACK	PIN LOCATION 5 & 6	OPTION 1	87023-0001
BLACK	PIN LOCATION 23 & 24	OPTION 1	87023-0002
BLACK	PIN LOCATION 5 & 6	OPTION 2	87023-0003
BLACK	PIN LOCATION 23 & 24	OPTION 2	87023-0004
BLACK	NO VOID	OPTION 1	87023-0005

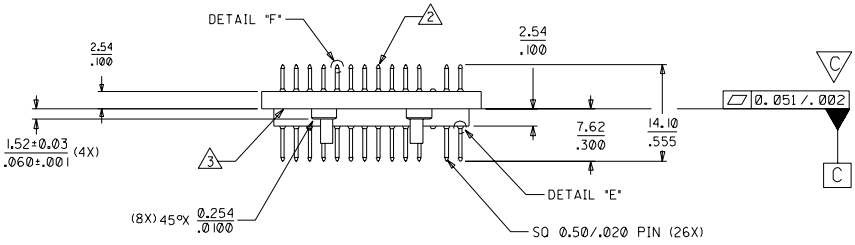

NOTES:

- PLATING :
 OPTION 1: 150µIN MIN. GOLD OVER 50µIN MIN. TO 100µIN MAX. NICKEL MEASURED AT .080 INCH FROM BOTH ENDS OF THE PINS.
 OPTION 2: 30µIN MIN. GOLD OVER 50µIN MIN. TO 100µIN MAX. NICKEL MEASURED AT .080 INCH FROM BOTH ENDS OF THE PINS.
 BULLET HEAD PINS MUST BE INSERT-MOLDED.
 NO EJECTOR PIN MARKS, KNIT LINES AND SINK MARKS ARE ALLOWED AT THIS SURFACE. EJECTOR PIN MARKS ONLY PERMISSIBLE ON THIS SURFACE WITHIN THE RECTANGULAR AREA BONDED BY THE PINS 1, 2, 27 & 28.
- METRIC DIMENSION FOR REFERENCE ONLY.
- MATERIALS :
 HOUSING - POLYPHENYL SULFONE, RADEL R5100, UL94-V0
 CONTACTS - PHOSPHOR BRONZE
- PARTS SHALL BE PACKAGED IN TRAYS.
- MX LOGO, MFG LOCATION AND CAVITY NO. EG. THAILAND, 'MTHI' SINGAPORE, 'MXSI'
- PRODUCT SPECIFICATION PS-87023-003 APPLIES.

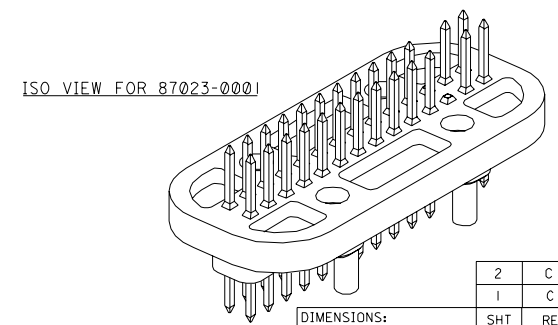
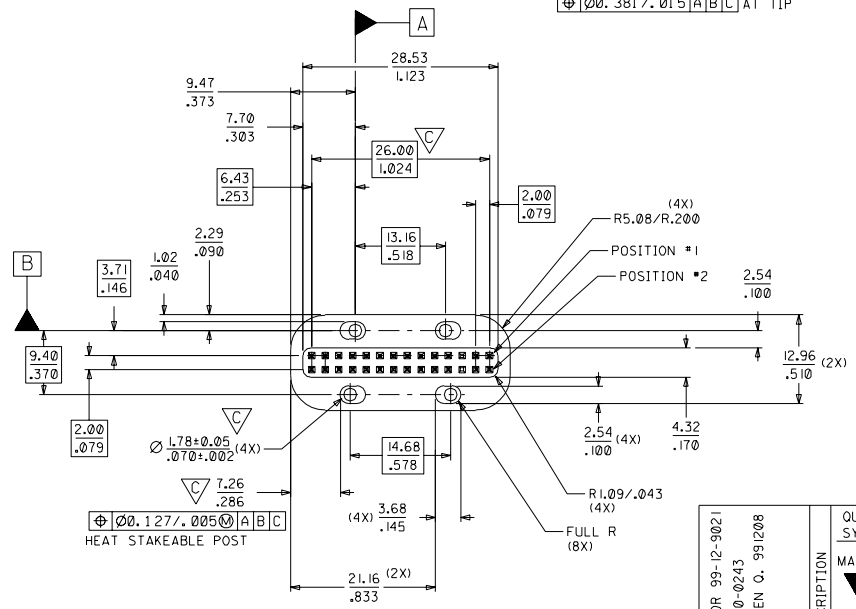

RELEASE PDR 99-12-9021 EC NO. S2000-0243 DRWN: STEVEN Q. 991208 CHK: CHK: APPR:	QUALITY SYMBOLS MAJOR ▼ = 0 CRITICAL ▼ = 4	GENERAL TOLERANCES: (UNLESS SPECIFIED) mm INCH 4 PLACES ±0. — ±. — 3 PLACES ±0. — ±. — 2 PLACES ±0.25 ±.010 1 PLACE ±0. — ±. — ANGULAR: ± °	SCALE DESIGN UNITS <input checked="" type="checkbox"/> mm <input type="checkbox"/> INCH DRAWN BY & DATE CS LIM 980302 CHECKED BY & DATE LILY CHANG 980416 APPROVED BY & DATE JAMES LIM 980416	TITLE: 2.00 MM 28 CKT INSERT MOLDED HEADER	DIMENSIONS: <input checked="" type="checkbox"/> mm <input type="checkbox"/> INCH <input type="checkbox"/> mm ONLY	THIRD ANGLE PROJECTION	SHEET NO. 1 OF 2 REVISE ON CAD ONLY
					CAD FILENAME NA	MATERIAL NO. SEE CHART	DRAWING NO. SD-87023-001

8

7

6

5

4

3

2

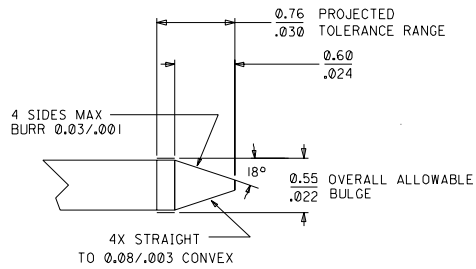

DETAIL D : BOTH ENDS, 26 PLACES

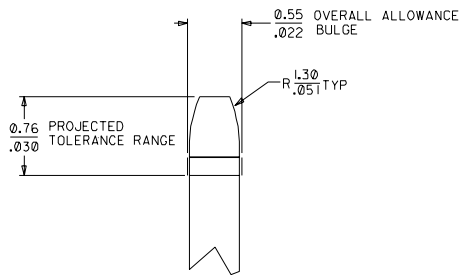

DETAIL F

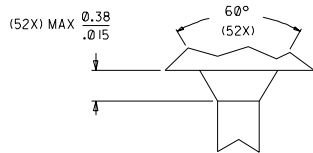

DETAIL E

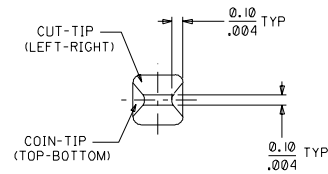

TIP DETAIL

RELEASE PDR 99-12-9021 EC NO. 52000-0243 DRWN: STEVEN Q. 991208 CHK: APPR:	DESCRIPTION	QUALITY SYMBOLS	GENERAL TOLERANCES: (UNLESS SPECIFIED)		SCALE	DESIGN UNITS	THIRD PROJECT
		MAJOR ▼ = 0 CRITICAL ▽ = 0	mm	INCH	NTS	mm <input checked="" type="checkbox"/> INCH <input type="checkbox"/>	
C	REV	4 PLACES	±0. —	±. —	DRAWN BY & DATE CS LIM 980302		TITLE: 2.00 MM
		3 PLACES	±0. —	±. —	CHECKED BY & DATE LILY CHANG 980416		
		2 PLACES	±0.25	±.010	APPROVED BY & DATE JAMES LIM 980416		MATERIAL NO. SEE CHART
		1 PLACE	±0. —	±. —	CAD FILENAME NA		
			ANGULAR: ± °		THIS DRAWING CONTAINS INFORMATION INCORPORATED AND SHOULD NOT BE US		