

Agilent HLMP-CW78, HLMP-CW79, T-1 3/4 Precision Optical Performance White LED Data Sheet

Description

This high intensity white LED lamp is based on InGaN material technology. A blue LED die is coated by phosphor to produce white. The typical resulting color is described by the coordinates $x = 0.32$, $y = 0.32$ using the 1931 CIE Chromaticity Diagram.

This T-1 3/4 lamp is untinted, diffused, and incorporate precise optics which produce well defined spatial radiation patterns at specific viewing cone angle.

Benefit

- Reduced Power Consumption, Higher Reliability, and Increased Optical/Mechanical Design Flexibility Compared to Incandescent Bulbs and Other Alternative White Light Sources

Features

- Highly Luminous White Emission
- 70° viewing angle
- New InGaN flip chip die technology with protective diode.
- ESD class 3

Applications

- Electronic Signs and Signals
- Small Area Illumination
- Legend Backlighting
- General Purpose Indicators

Package Dimensions

Package Dimension of HLMP-CW78

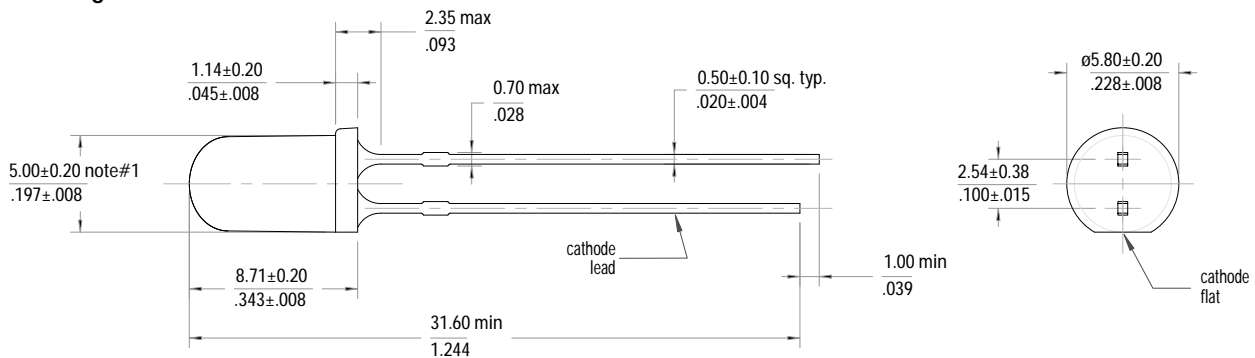

Package Dimension of HLMP-CW79

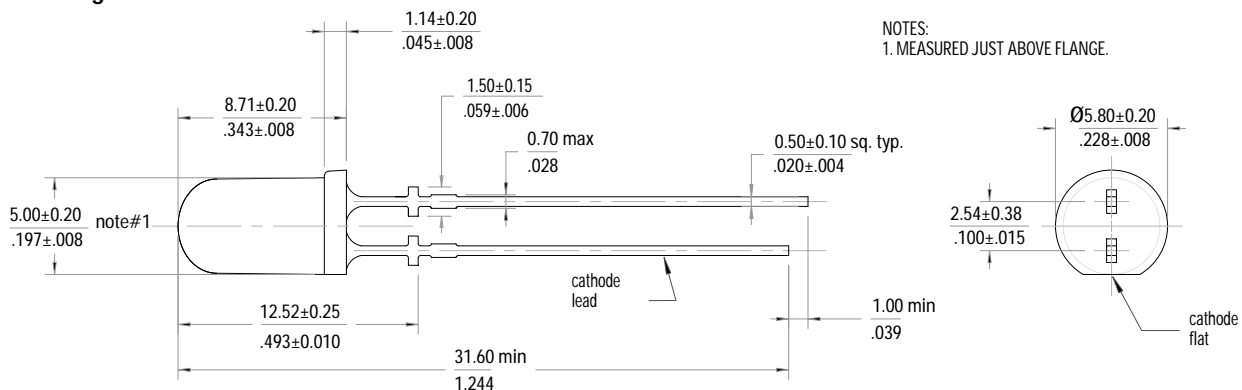

NOTES:
1. MEASURED JUST ABOVE FLANGE.

Device Selection Guide

Part Number	Typ. Viewing Angle	Luminous Intensity (mcd) @ 20mA		Standoff Leads
		Minimum	Typical	
HLMP-CW78-LP0xx	70°	400	670	No
HLMP-CW79-LP0xx	70°	400	670	Yes

Notes:

1. Tolerance for luminous intensity measurement is +/- 15%
2. The luminous intensity is measured on the mechanical axis of the lamp package.
3. The optical axis is closely aligned with the package mechanical axis.

Part Numbering System

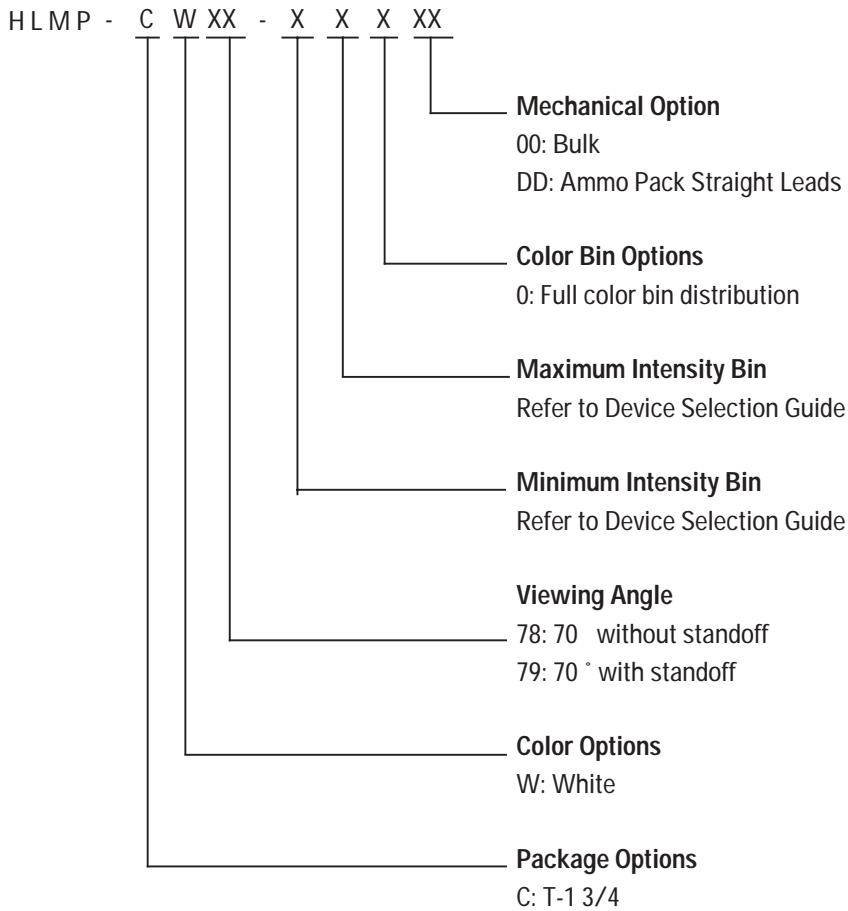

Absolute Maximum Ratings ($T_A = 25^\circ\text{C}$)

Parameter	Value	Units
DC Forward Current ^[1]	30	mA
Peak Forward Current	100	mA
Average Forward Current	30	mA
Power Dissipation	120	mW
LED Junction Temperature	130	°C
Operating Temperature Range	-40 to +85	°C
Storage Temperature Range	-40 to +100	°C

Notes:

1. Derate linearly as shown in Figure 5.
2. Duty factor 30%, frequency 1kHz

Electrical/Optical Characteristics ($T_A = 25^\circ\text{C}$)

Parameters	Symbol	Minimum	Typical	Maximum	Units	Test Condition
Forward voltage	V_F		3.4	4.0	V	$I_F = 20\text{ mA}$
Capacitance	C		53		pF	$V_F=0, f=1\text{ MHz}$
Reverse Voltage ^[1]	V_R		0.6		V	$I_R = 10\ \mu\text{A}$
Thermal resistance	$R\theta_{J-PIN}$		240		°C/W	LED Junction to cathode lead
Viewing Angle ^[2]	$2\theta_{1/2}$		70		Degree	$I_F = 20\text{ mA}$
Chromaticity Coordinate ^[3]	X Y		0.31 0.32			$I_F = 20\text{ mA}$

Notes:

1. The reverse voltage of the product is equivalent to the forward voltage of the protective chip at $I_R = 10\ \mu\text{A}$
2. $2\theta_{1/2}$ is the off-axis angle where the luminous intensity is $\frac{1}{2}$ the on axis intensity
3. The chromaticity coordinates are derived from the CIE 1931 Chromaticity Diagram and represent the perceived color of the device.

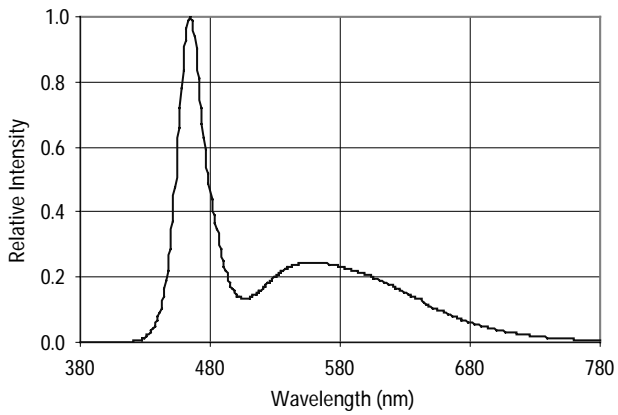

Figure 1. Relative Intensity vs. Wavelength

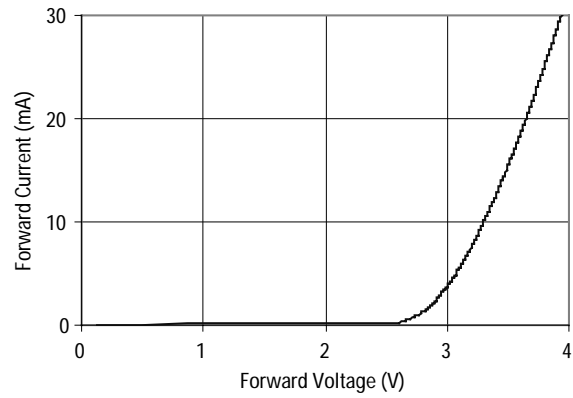

Figure 2. Forward Current vs. Forward Voltage

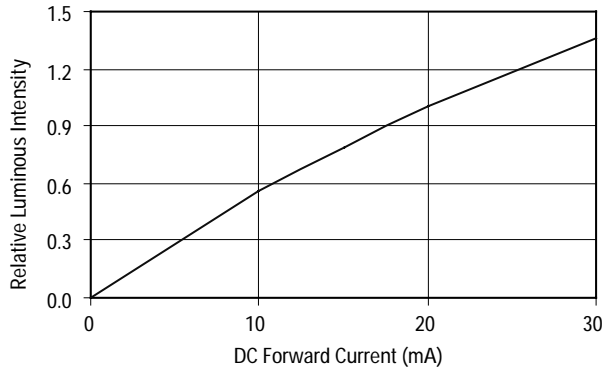

Figure 3. Relative Iv vs. Forward Current

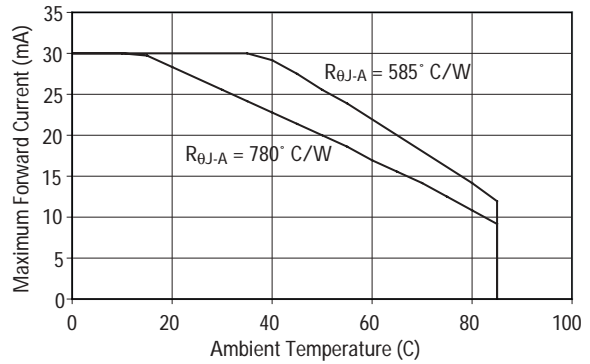

Figure 4. Maximum Forward Current vs. Temperature

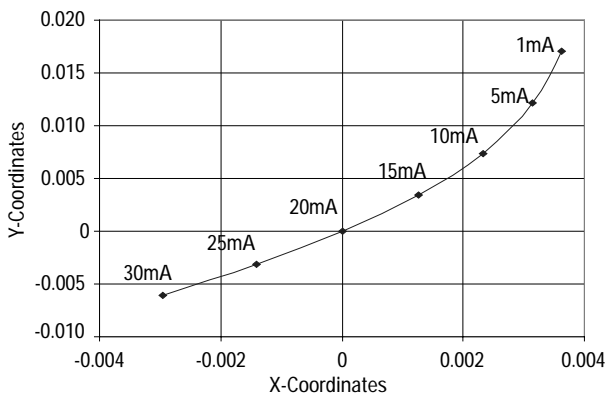

Figure 5. Chromaticity Coordinate Change over Forward Current

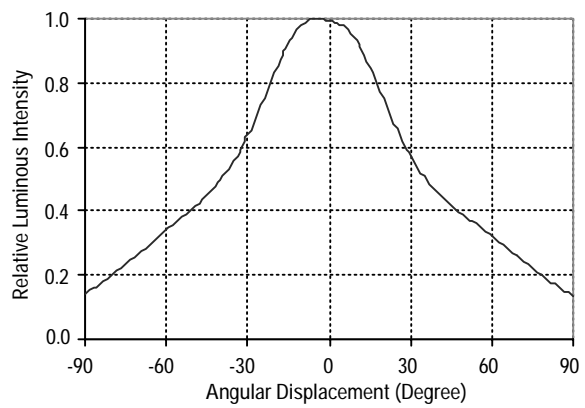

Figure 6. Radiation Pattern

Intensity Bin Limits (mcd at 20 mA)

Bin	Min.	Max.
L	400	520
M	520	680
N	680	880
P	880	1150

Tolerance for each bin limit is $\pm 15\%$.

Color Bin Limit Tables

Rank	Limits (Chromaticity Coordinates)				
	1	x	0.330	0.330	0.356
	y	0.360	0.318	0.351	0.385
2	x	0.287	0.296	0.330	0.330
	y	0.295	0.276	0.318	0.339
3	x	0.264	0.280	0.296	0.283
	y	0.267	0.248	0.276	0.305
4	x	0.283	0.287	0.330	0.330
	y	0.305	0.295	0.339	0.360

Tolerance for each bin limit is ± 0.01

Note:

- Bin categories are established for classification of products. Products may not be available in all bin categories. Please contact your Agilent representative for information on currently available

Color Bin Limits with Respect to CIE 1931 Chromaticity Diagram

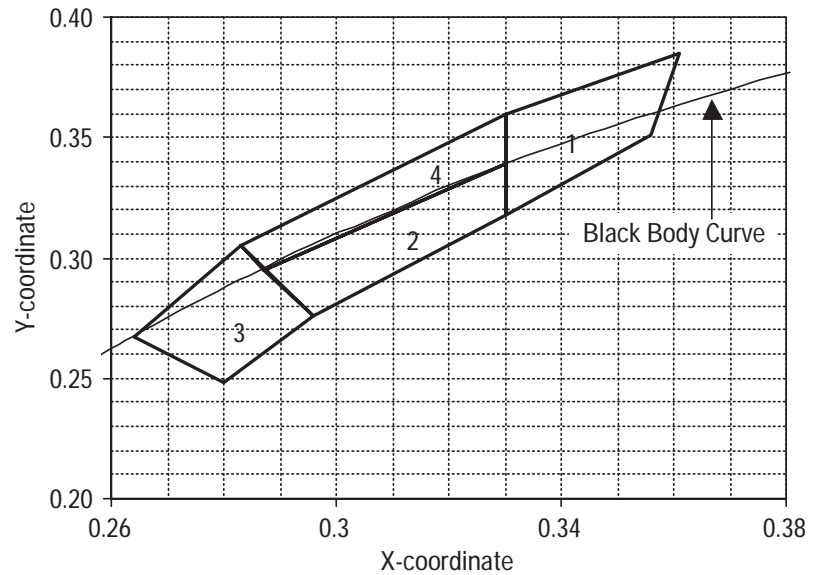

Precautions:

Lead Forming:

- The leads of an LED lamp may be preformed or cut to length prior to insertion and soldering into PC board.
- If lead forming is required before soldering, care must be taken to avoid any excessive mechanical stress induced to LED package. Otherwise, cut the leads of LED to length after soldering process at room temperature. The solder joint formed will absorb the mechanical stress of the lead cutting from traveling to the LED chip die attach and wirebond.
- It is recommended that tooling made to precisely form and cut the leads to length rather than rely upon hand operation.

Soldering Condition:

- Care must be taken during PCB assembly and soldering process to prevent damage to LED component.
- The closest LED is allowed to solder on board is 1.59mm below the body (encapsulant epoxy) for those parts without standoff.
- Recommended soldering condition:

	Wave Soldering	Manual Solder Dipping
Pre-heat temperature	105 °C Max.	–
Preheat time	30 sec Max	–
Peak temperature	250 °C Max.	260 °C Max.
Dwell time	3 sec Max.	5 sec Max

- Wave soldering parameter must be set and maintain according to recommended temperature and dwell time in the solder wave. Customer is advised to periodically check on the soldering profile to ensure the soldering profile used is always conforming to recommended soldering condition.
- If necessary, use fixture to hold the LED component in proper orientation with respect to the PCB during soldering process.
- Proper handling is imperative to avoid excessive thermal stresses to LED components when heated. Therefore, the soldered PCB must be allowed to cool to room temperature, 25°C before handling.
- Special attention must be given to board fabrication, solder masking, surface plating and lead holes size and component orientation to assure solderability.
- Recommended PC board plated through holes

LED component lead size	Diagonal	Plated through hole diameter
0.457 x 0.457mm (0.018 x 0.018inch)	0.646 mm (0.025 inch)	0.976 to 1.078 mm (0.038 to 0.042 inch)
0.508 x 0.508mm (0.020 x 0.020inch)	0.718 mm (0.028 inch)	1.049 to 1.150mm (0.041 to 0.045 inch)

Note: Refer to application note AN1027 for more information on soldering LED components.

Recommended Wave Soldering Profile

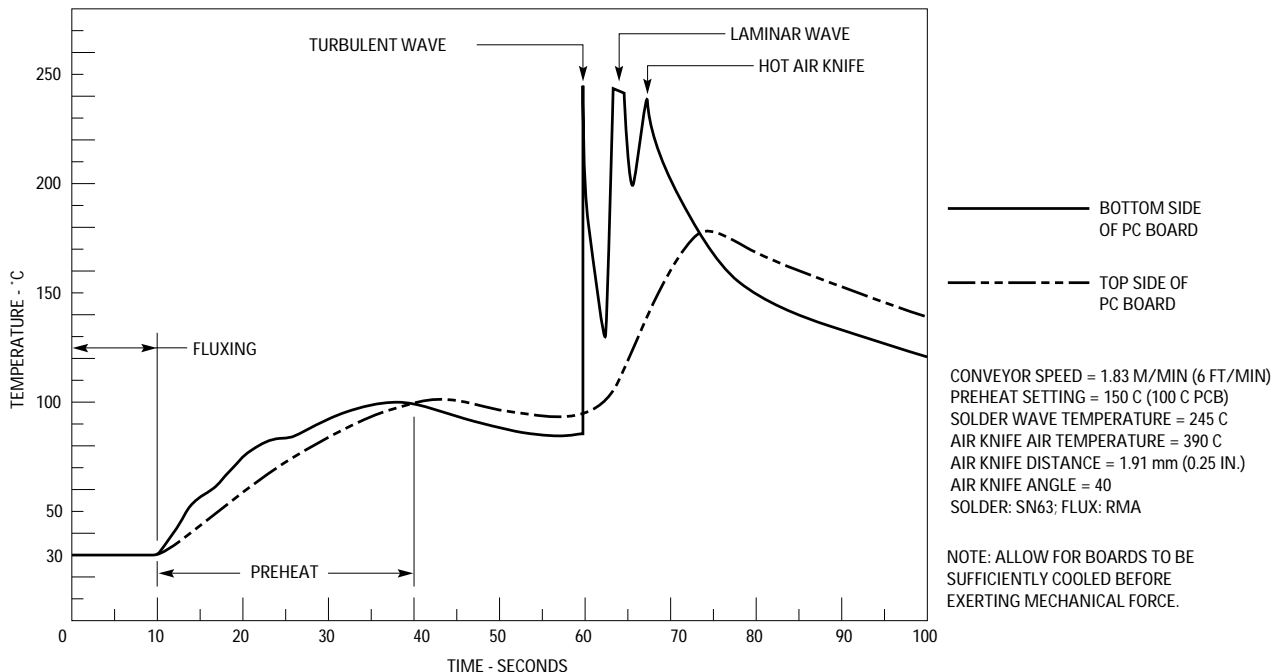

**www.agilent.com/
semiconductors**

For product information and a complete list of distributors, please go to our web site.

For technical assistance call:

Americas/Canada: +1 (800) 235-0312
or (916) 788-6763

Europe: +49 (0) 6441 92460

China: 10800 650 0017

Hong Kong: (+65) 6756 2394

India, Australia, New Zealand: (+65) 6755 1939

Japan: (+81 3) 3335-8152 (Domestic/International), or 0120-61-1280 (Domestic Only)

Korea: (+65) 6755 1989

Singapore, Malaysia, Vietnam, Thailand, Philippines, Indonesia: (+65) 6755 2044

Taiwan: (+65) 6755 1843

Data subject to change.
Copyright 2005 Agilent Technologies, Inc.
October 31, 2005
Obsoletes 5989-0460EN
5989-4154EN