

DATE	REV	ECN	APP'D. BY
1/30/06	A1	7462	JM
6-25-09	A2	8769	JM
2-14-11	A3	9128	TRM

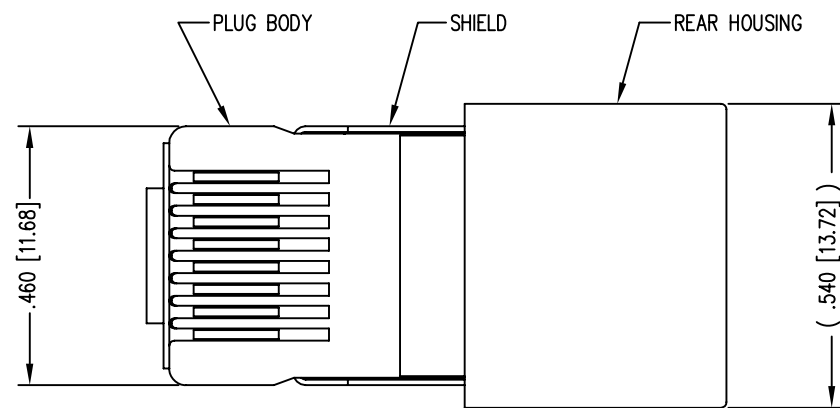

(SHOWN ASSEMBLED)

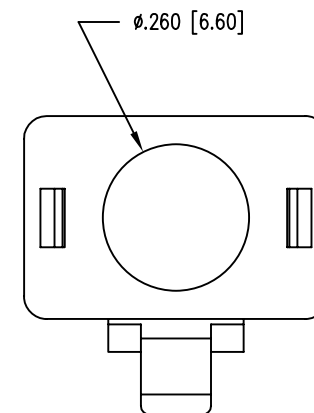
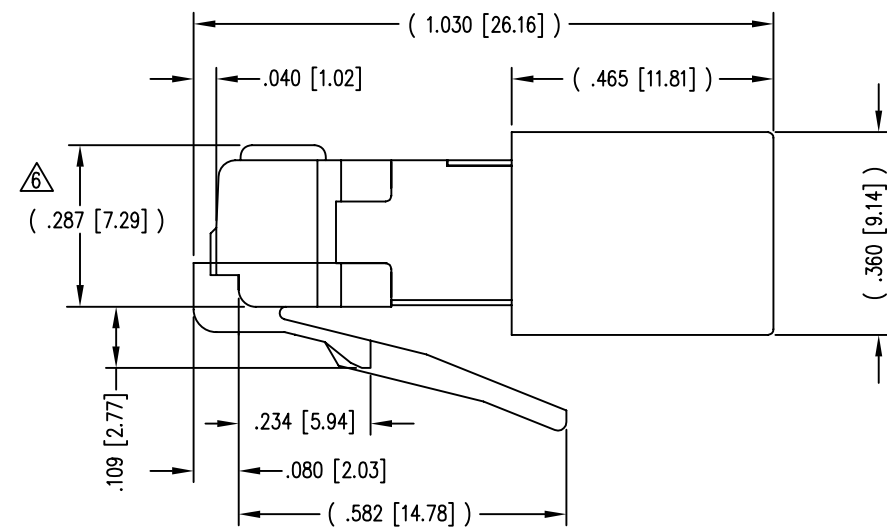
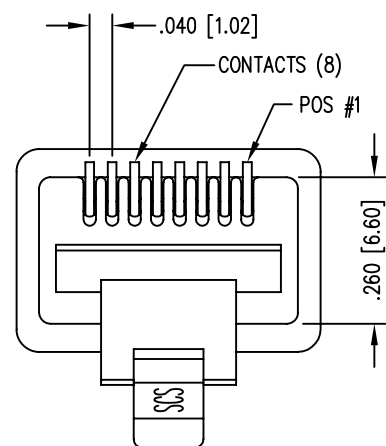

NOTES:

- 1- PLUG KIT CONSISTS OF :
PRE-INSERTED PLUG HOUSING & SHIELD
MANAGEMENT BAR
FERRULE
- 2- MATERIALS :
FRONT HOUSING PLASTIC : CLEAR POLYCARBONATE, UL 94-V0
MANAGEMENT BAR : CLEAR POLYCARBONATE, UL 94-V0
SHIELD : TIN PLATED BRASS
CONTACTS : PHOSPHOR BRONZE, SELECTIVE GOLD PLATING
FERRULE : NICKEL OR TIN PLATED BRASS
- 3- CONTACTS TERMINATE STRANDED & SOLID CONDUCTORS UP TO .042 [1.07] OUTSIDE DIAMETER OF INSULATION.
- 4- FOR PRODUCT SPECIFICATION SEE PR026-01.
- 5- DIMENSIONS AND TOLERANCES COMPLY WITH TIA-1096 STANDARD.
- 6- TERMINATED PLUG HEIGHT: .237 [6.02] ±.005 [0.13]
- 7- DESIGNED FOR CATEGORY 5/5e APPLICATIONS.

BULK	50 MICRO-INCHES [1.27um]	943-SP-370808SM2-A10
PACKAGE	CONTACT PLATING IN MATING AREA	PART NUMBER

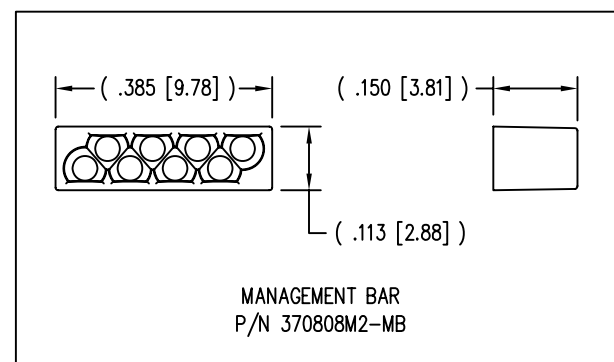
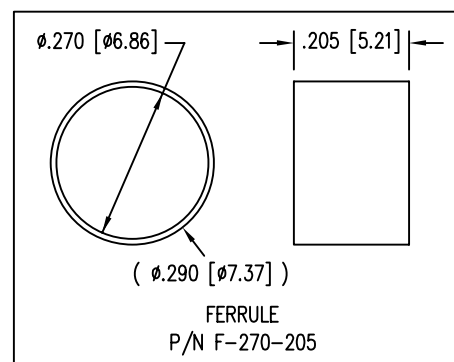

THIRD ANGLE PROJECTION

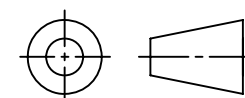

DO NOT SCALE DRAWING
DRAWING IS SUBJECT TO
CHANGE WITHOUT NOTICE

DIMENSIONS: INCHES [METRIC]

UNLESS OTHERWISE SPECIFIED
TOLERANCES ARE ±.005 [0.13]
ANGLES ARE ± 1°

SHEET NO. 1 OF 1

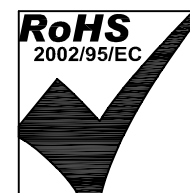

Bel Stewart Connector

11118 Susquehanna Trail South
Glen Rock, PA 17327-9199
(717) 235-7512 Fax: (717) 235-7954 <http://www.stewartconnector.com>

TITLE: SHIELDED CAT 5 PLUG, 8 X 8 SHIELDED PLUG

THIS DRAWING AND THE SUBJECT MATTER SHOWN THEREON ARE CONFIDENTIAL AND THE PROPRIETARY PROPERTY OF BEL STEWART CONNECTOR AND SHALL NOT BE REPRODUCED, COPIED, OR USED IN ANY MANNER WITHOUT PRIOR WRITTEN CONSENT OF BEL STEWART CONNECTOR. THE SUBJECT MATTER MAY BE PATENTED OR A PATENT MAY BE PENDING.

DRN BY:	R.S.	DATE	11-8-96
APPD BY:	R.J.	DATE	11-8-96
DWG NO.	CT370012	REV.	A3

REV. 7/3/03