

THIS DOCUMENT IS THE PROPERTY OF
KEYSTONE ELECTRONICS CORP. AND
SHALL NOT BE REPRODUCED, DISTRIBUTED
OR USED AS A BASIS FOR MANUFACTURE
WITHOUT PRIOR WRITTEN PERMISSION
FROM KEYSTONE ELECTRONICS CORP.

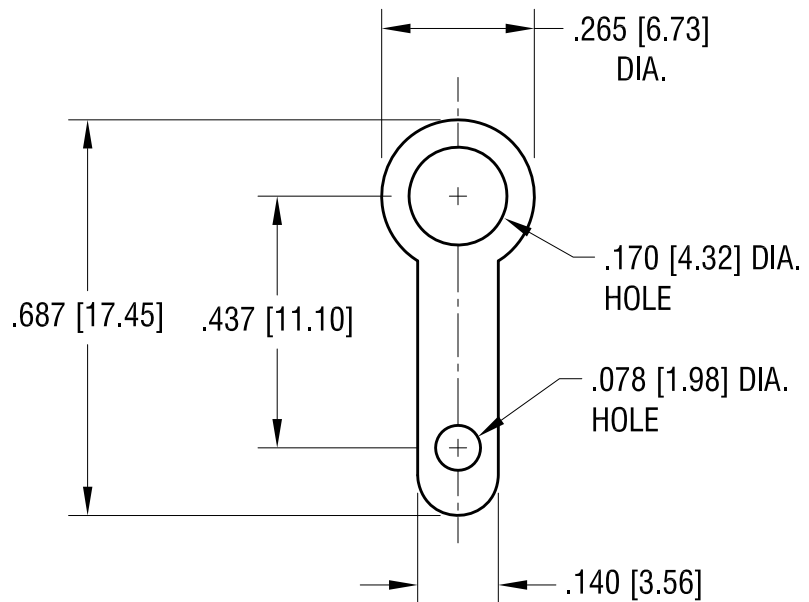
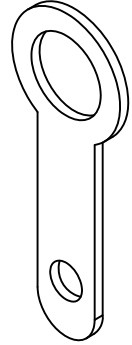

KEYSTONE ELECTRONICS CORP.			
www.keyelco.com • ASTORIA, N.Y. 11105-2017 • Tel (718) 956-8900			
PART NAME		SOLDER TERMINAL LUG	
MATERIAL		.020 [0.50] TH'K BRASS	
FINISH	MATTE TIN PLATE	DRN BY BOONE	DATE 3.15.84
		APP'D LN	SCALE 3X
TOLERANCES	INCH [MM]	CODE	DWG NO.
DECIMAL	± .005 [± 0.15]	C	7327
ANGULAR	± 1°		
UNLESS OTHERWISE SPECIFIED			

6.25.09	CHANGE AS PER ECN 09-082	B
1.9.08	CHANGE AS PER ECN 08-041	A
DATE	DESCRIPTION	REV.